



**NORTHLAND  
POWER**

# Crosby Solar Project

## Draft Noise Assessment Report

March 4, 2011



Northland Power Inc.  
on behalf of  
Northland Power Solar  
Crosby L.P.  
Toronto, Ontario

## DRAFT Noise Assessment Report

Crosby Solar Project

H334844-0000-07-124-0069

Rev. 1

March 04, 2011

Project Report

March 4, 2011

**Northland Power Inc.  
Crosby Solar Project**

## **DRAFT Noise Assessment Report**

Blank back

## Executive Summary

This report presents the results of the noise assessment study required for Solar Facilities under Regulation 359/09, as part of the Renewable Energy Approval (REA) Process.

Northland Power Solar Crosby L.P. (hereinafter referred to as “Northland”) has retained Hatch Ltd. (Hatch) to prepare a Noise Assessment Study for the Northland Power Crosby Solar-Photovoltaic facility (hereinafter referred to as the “Project”), with an installed capacity of 10 MW. The Project will be located on approximately 52 hectares of land, located at 249 Little Rideau Lake Road in the Township of Rideau Lakes, within the United Counties of Leeds and Grenville, Ontario.

This Noise Assessment Study has been prepared based on the document entitled “Basic Comprehensive Certificates of Approval (Air) – User Guide” by the Ontario Ministry of the Environment (MOE). The sound pressure levels at the points of reception (POR) have been estimated using ISO 9613-2, implemented in the CADNA-A computer code. The performance limits used for verification of compliance correspond to the values for rural areas (45 dBA for day time, 40 dBA for night time). The results presented in this report are based on the best available information at this time. It is the intention that, in the detailed engineering phase of the project, certified noise data based on final plans and designs will confirm the conclusions of this noise study.

Based on the results obtained in this study, we believe that the sound pressure levels at POR will not exceed MOE requirements for rural areas. Any noise issues that might arise during commissioning will be manageable and can be resolved by implementing typical remediation measures as described in this report. It is our intention to verify by field measurements taken on completion of installation and during commissioning that the noise levels at the POR are within the limits set by the MOE.

Blank back

## Table of Contents

<b>1. Introduction .....</b>	<b>1</b>
<b>2. Facility Description .....</b>	<b>1</b>
2.1 Site Location .....	1
2.2 Acoustical Environment .....	2
2.3 Life of Project.....	2
2.4 Operating Hours .....	2
2.5 Approach to the Study.....	2
<b>3. Noise Source Summary .....</b>	<b>5</b>
3.1 Substation .....	5
3.2 Inverter Clusters (Pads).....	5
3.3 Noise Summary Table.....	5
<b>4. Point of Reception Summary .....</b>	<b>6</b>
<b>5. Impact Assessment .....</b>	<b>7</b>
5.1 Compliance With Performance Limits .....	7
<b>6. Mitigation Measures .....</b>	<b>8</b>
<b>7. Conclusions and Recommendations .....</b>	<b>8</b>
<b>8. References.....</b>	<b>8</b>
<b>Appendix A</b>	<b>Land-Use Zoning Designation Plan, Area Location Plan and Plant Layout</b>
<b>Appendix B</b>	<b>Noise Sources</b>
<b>Appendix C</b>	<b>Sound Pressure Levels for Points of Reception, Noise Maps from CADNA-A</b>

## List of Tables

Table 2.1	General Project Description .....	1
Table 3.1	Noise Source Summary .....	6
Table 4.1	Point of Reception Noise Impact (Day Time) .....	6
Table 5.1	Performance Limits (One-Hour $L_{eq}$ ) by Time of Day for Class 3 Areas .....	7
Table 5.2	Acoustic Assessment Summary (Day and Night Time) .....	7
Table 6.1	Barrier Description .....	8

## List of Figures

Figure 2.1	Project Location .....	3
------------	------------------------	---



## 1. Introduction

This report presents the results of the noise assessment study required for Solar Facilities under Regulation 359/09, as part of the Renewable Energy Approval (REA) Process.

Northland Power Solar Crosby L.P. (hereinafter referred to as “Northland”) retained Hatch Ltd. (Hatch) to prepare a Noise Assessment Study for the Northland Power Solar Crosby L.P. facility (hereinafter referred to as the “Project”), with an installed capacity of 10 MW. The Project will be located within the United Counties of Leeds and Grenville, Ontario.

The report was prepared according to publication “Basic Comprehensive Certificates of Approval (Air) – User Guide, 2004” by the Ministry of the Environment (MOE), and includes a general description of the facility, sources and points of reception (POR), assessment of compliance, as well as all the supporting information relevant to the Project.

## 2. Facility Description

The Project will utilize photovoltaic (PV) panels installed on fixed racking structures, mounted on the ground. The PV panels generate DC electricity, which is converted to 560-V AC electricity by clusters of inverters. The 560-V power is transformed to 27.6 kV by a transformer located at each inverter cluster. The 27.6-kV power is brought to a single central substation transformer to be stepped up to 44 kV for transmission away from the site.

Since the panels will be ground-mounted and the total nameplate capacity is over 10 kW, the Project is considered to be a Class 3 Solar Facility, according to the classification presented in Regulation 359/09.

A general description of the Project is provided in Table 2.1.

**Table 2.1 General Project Description**

<b>Project Description</b>	<b>Ground-mounted Solar PV, Class 3</b>
<b>System Nameplate Capacity</b>	<b>10 MW AC/10 MVA</b>
<b>Local Distribution Company</b>	<b>Hydro One Networks Inc.</b>
<b>Approximate Coordinates</b>	<b>Latitude 44°40'14" N, Longitude 76°18'17" W</b>

### 2.1 Site Location

The property consists of agricultural land totalling approximately 52 hectares, located about 2.2 km north of Newboro, in the Township of Rideau Lakes. Figure 2.1 shows the geographical location of the Project, as well as areas to be occupied with the PV panels. The detailed scaled Zoning Designation Plan and Area Location Plan drawings are included in Appendix A. A total of 85 receptors are located within 1.6 km from the substation.

For modelling purposes, the vegetation that blocks some of the POR from the sources has not been incorporated.

## 2.2 Acoustical Environment

The Project will be surrounded by farmland, with some forested areas to the southwest. The background noise levels are expected to be typical of rural areas, classified as a Class 3 based on Publication NPC-232 by the MOE. Some traffic noise is expected from Regional Road 42 (1 km to the south), mainly during day hours. The closest airport is located at 6 km to the west of the Project site (Westport/Rideau Lakes Airport). The Town of Newboro is located 2 km southwest of the proposed location.

There are no large industrial facilities within 5 km of the Project area, except for a substation located about 1 km to the south.

## 2.3 Life of Project

The expected life of the Project is 30 years. The manufacturer's warranty on the PV modules is 25 years and the expected life of solar power plants of this type is 35 to 40 years.

## 2.4 Operating Hours

Solar PV facilities produce electricity during the day hours, when the sun's rays are collected by the panels. After sunset, the plant will not receive solar radiation to generate any electricity. Under these conditions, the inverters will not produce noise and the transformers will be energized, but not in operation (no fans).

## 2.5 Approach to the Study

The sound pressure levels at the POR were predicted using procedures from ISO 9613-2, which is a widely used standard for evaluation of noise impact in environmental assessments. The sound power levels were estimated from the National Electrical Manufacturers Association standards (NEMA) for the substation transformer. The inverter manufacturer provided the noise data for the inverter clusters, which include the medium-voltage transformer. The software package CADNA-A, which implements ISO-9613-2, was used to predict the noise levels at the closest POR. This numerical modelling software is able to handle the sound sources present in the Project, as well as considering atmospheric and ground attenuation. The height contours for the site were taken from the Ontario Base Maps (OBM).

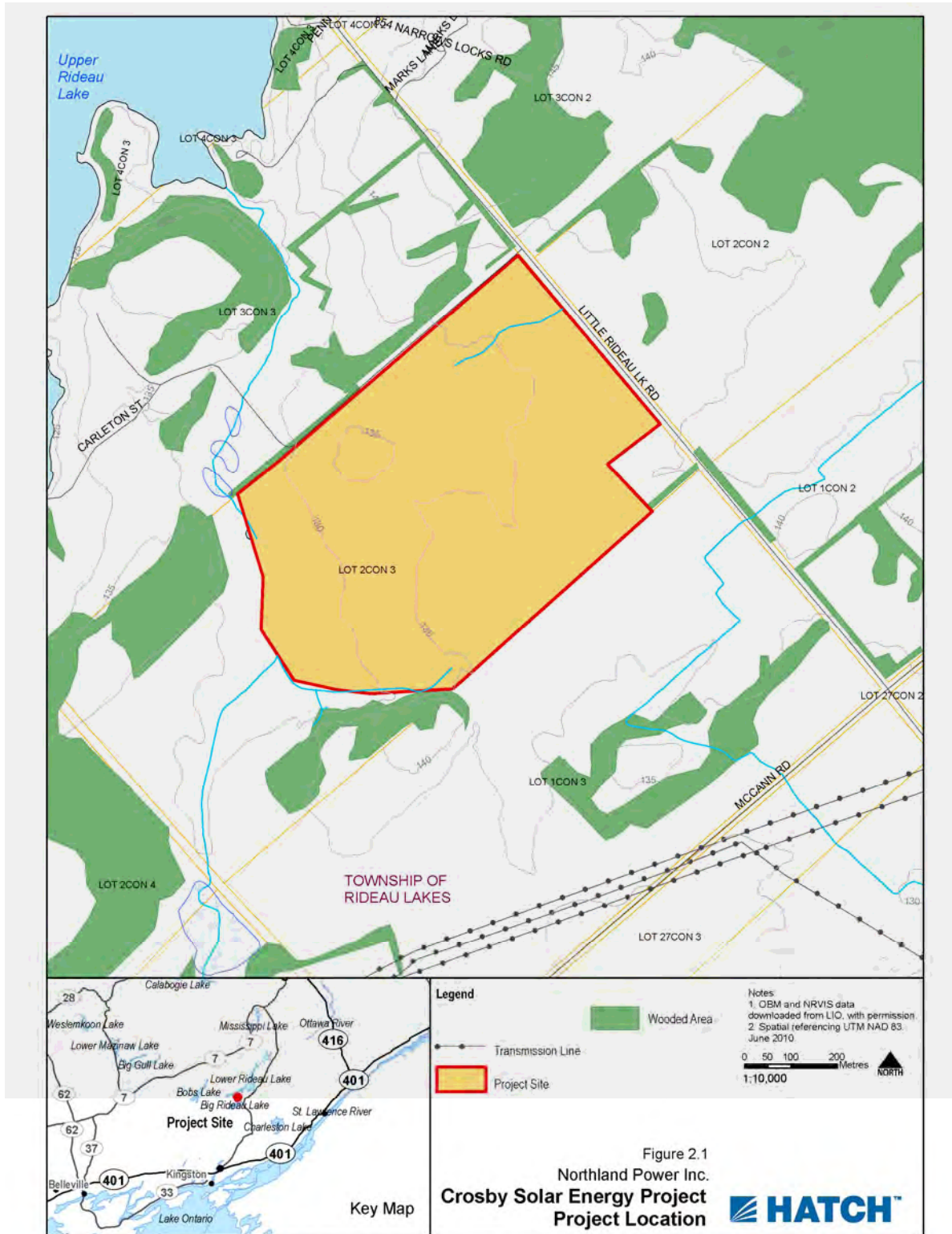

Figure 2.1 Project Location

Blank back

### 3. Noise Source Summary

The main sources of noise from the Project will be the step-up transformer, located at the substation, and eight inverter clusters which also include medium-voltage transformers. Northland provided a layout of the solar PV facility (see Figure A3, Appendix A). The coordinates of each source are presented in Appendix B.

#### 3.1 Substation

At this point, it is anticipated that the step-up power transformer located in the substation will have a capacity of 10 MVA. In addition, the transformer will be oil-filled with air-forced cooling (ONAF). For the purpose of evaluating the potential noise impacts of the transformer, the sound power level was estimated using data from NEMA TR1-1993 (2000). This standard provides maximum sound level values for transformers, and manufacturers routinely meet this specification. Hence, the results based on NEMA slightly overestimate the impact on POR. The NEMA levels were then converted into frequency spectra using empirical correlations for transformer noise (Harris, 1998).

Power transformers are considered by the MOE to be tonal noise sources. A 5-dBA penalty will be added to the sound power spectrum, as recommended by Publication NPC-104, "Sound Level Adjustments," for tonality. Table B2, Appendix B, shows the frequency spectrum used to model the substation transformer.

#### 3.2 Inverter Clusters (Pads)

At this stage of the Project, Northland is planning to use inverter clusters manufactured by SMA. Each Sunny Central SC1250MV unit comprises two 630HE inverters (630 kW), contained in an e-house or enclosure (see Appendix B). The main sources of noise are the cooling/ventilation fans for the inverters, the electrical components on the inverters and the medium-voltage transformer.

The installed capacity of each inverter cluster is 1.25 MW, as shown in Table 3.1. SMA provided third-octave noise data for the inverter cluster unit, which includes the medium-voltage transformer (see Appendix B). A 5-dBA penalty was added to the frequency spectrum, as stipulated in Publication NPC-104, "Sound Level Adjustments," to allow for tonality. The frequency spectra used for the inverter clusters and medium-voltage transformers is shown in Table B2, Appendix B.

The "barrier effect" provided by the solar panels surrounding the inverter clusters has not been modelled, which means that the sound pressure levels predicted at the POR can be higher than would be the case if the barrier was accounted for. Note also that, at night time, the facility will not operate. Under these conditions, the inverters do not produce noise. The medium-voltage transformers are energized and make some magnetostrictive noise at a reduced level, but no cooling fans are in operation. Since the noise data provided by SMA combines both inverter and transformer, the CADNA-A model will assume that the cluster will be operating 24 hours.

#### 3.3 Noise Summary Table

A summary of the sound sources described above, including sound level, characteristics and potential noise control measures, is presented in Table 3.1.

**Table 3.1 Noise Source Summary**

Source ID	Source Description	Overall Sound Power Level (dBA)	Source Location	Sound Characteristics	Noise Control Measures
1	Subs. Transformer: 10 MVA	93.3	O	S-T	B
2	Inverter Cluster #1: 1.25 MW	102.2	O	S-T	E,S
3	Inverter Cluster #2: 1.25 MW	102.2	O	S-T	E,S
4	Inverter Cluster #3: 1.25 MW	102.2	O	S-T	E,S
5	Inverter Cluster #4: 1.25 MW	102.2	O	S-T	E,S
6	Inverter Cluster #5: 1.25 MW	102.2	O	S-T	E,S
7	Inverter Cluster #6: 1.25 MW	102.2	O	S-T	E,S
8	Inverter Cluster #7: 1.25 MW	102.2	O	S-T	E,S
9	Inverter Cluster #8: 1.25 MW	102.2	O	S-T	E,S

**Notes:**

1. A 5-dBA penalty is included in this table.
2. Location: Inside building (I), Outside building (O).
3. Sound Characteristics: Steady (S), Tonal (T), Impulsive (I), Quasi-Steady Impulsive (QSI).
4. Noise Control: Silencer (S), Acoustic lining (A), Barrier (B), Lagging (L), Enclosure (E), Other (O), Uncontrolled (U).

## 4. Point of Reception Summary

The POR used in this study have been taken from the OBM for the surrounding area. Some additional receptors (residential buildings) were added based on satellite imagery from Google Earth Pro (2002). The total number of POR within a 1-km radius from the substation is 22 (see Figure A2). Three of these receptors have been chosen as representative for evaluating the noise impact from the facility, and are presented in Table 4.1 (see Figure A2 in Appendix A). The complete set of results is included in Appendix C, including a noise map from CADNA-A. For this study, the elevation above ground of the POR is 4.5 m.

**Table 4.1 Point of Reception Noise Impact (Day Time)**

Source ID	POR 1		POR 7		POR 23	
	Distance (m)	Leq Sound Level at POR 1 (dBA)	Distance (m)	Leq Sound Level at POR 7 (dBA)	Distance (m)	Leq Sound Level at POR 23 (dBA)
1	92	31.2	263	27.6	1050	20.0
2	254	30.0	435	24.7	935	14.7
3	414	25.8	440	25.3	726	16.8
4	664	18.2	700	17.2	505	24.1
5	436	25.4	529	23.6	736	19.0
6	703	16.6	784	15.5	550	23.3
7	493	24.3	636	21.9	768	18.5
8	757	15.8	873	14.5	614	19.2
9	568	23.0	743	20.5	815	17.6

## 5. Impact Assessment

The purpose of the acoustic assessment report is to demonstrate that the facility is in compliance with the noise performance limits. The Project will be located in a Class 3 Area, based on the classification defined in Publication NPC-232 by the MOE. Class 3 area means a rural area with an acoustical environment that is dominated by natural sounds, having little or no traffic, such as an agricultural area.

Table 5.1 shows the performance limits set by the MOE for Class 3 Areas, according to Publication NPC-232.

**Table 5.1 Performance Limits (One-Hour  $L_{eq}$ ) by Time of Day for Class 3 Areas**

Time of Day	One Hour $L_{eq}$ (dBA)
	Class 3 Area
07:00 to 19:00	45
19:00 to 23:00	40
23:00 to 07:00	40

The Project will be operating during the day hours, that is, before 19:00 during most of the year. However, in the summer months, the sun may shine until past 21:00, although the inverters will be well below 100% loading conditions. This means that during the summer the Project will be operating at the time the applicable performance limit changes from 45 dBA to 40 dBA. At night time, the transformer is still energized, so the resultant sound pressure levels should be compared to the lower limit of 40 dBA. Note that since the frequency spectrum provided by the manufacturer includes the inverters and medium-voltage transformer at 100% loading conditions, it is assumed that both devices are operating during 24 hours. In reality, the only sound that could be perceived at night time is the magnetostrictive noise from the transformers.

For this study, the overall ground attenuation coefficient was assumed to be 0.7, which is commonly used by the MOE for evaluating the noise impact of other renewable energy facilities.

### 5.1 Compliance With Performance Limits

Table 5.2 presents the predicted sound pressure levels for the representative POR. The complete set of results is included in Appendix C.

**Table 5.2 Acoustic Assessment Summary (Day and Night Time)**

POR ID	POR Description	Sound Level at POR ( $L_{eq}$ ) Day / Night (dBA)	Verified by Acoustic Audit (Yes/No)	Performance Limit ( $L_{eq}$ ) Day / Night (dBA)	Compliance With Performance Limit (Yes/No)
1	House – East	35.7/35.7	No	45.0/40.0	Yes
7	House – Northeast	32.6/32.6	No	45.0/40.0	Yes
23	House – West	29.7/29.7	No	45.0/40.0	Yes

The results show that all POR are compliant with MOE guidelines based on the performance limits.



## 6. Mitigation Measures

Mitigation for operation of the Project has been modelled and shown to be feasible in the form of acoustic barriers for the substation, and enclosures with acoustical louvers for all inverters. The proposed considerations for these devices must be revisited when the specific dimensions and configuration of the enclosure are made available by the manufacturer.

The minimum construction requirements for the proposed noise barrier located next to the substation are presented in Table 6.1, as well as the approximate dimensions. Figure B1 and Table B3 in Appendix B present a diagram of the barrier design and the absorption coefficients used in the noise model. The noise reduction and sound transmission characteristics of the acoustical louvers considered in this report are presented in Table B4, Appendix B.

**Table 6.1 Barrier Description**

Mitigation ID	Location	Construction Requirements	Approximate Height (m)	Approximate Length (m)	Distance From Source (m)
BarrierS 1	See Figure B1	20 kg/m <sup>2</sup> , continuous	5.0	5.0	1.5
BarrierS 2	See Figure B1	20 kg/m <sup>2</sup> , continuous	5.0	5.0	1.5

While analysis indicates that no additional mitigation will be required, the noise levels will be verified at the closest POR after the Project goes into service. If measurements indicate a need to further reduce sound levels to satisfy MOE criteria, additional mitigation measures will be taken at the sources.

## 7. Conclusions and Recommendations

For the Project, the sound pressure levels at the POR have been estimated using the CADNA-A model, based on ISO 9613-2. The performance limits used for comparison correspond to Class 3 areas, with 45 dBA during day time (7:00 a.m. to 7:00 p.m.) and 40 dBA during night time. Mitigation for operation of the Project has been modelled and shown to be feasible.

Based on the results obtained in this study, it is concluded that the sound pressure levels at the POR will be below MOE requirements for Class 3 areas at night time (40 dBA) and day time (45 dBA).

## 8. References

- Harris, C. 1998. *Acoustical Measurements and Noise Control*, Third Edition. Acoustical Society of America.
- IEEE. 2006. C57.12.90-2006: Standard Test Code for Liquid-Immersed, Power and Regulating Transformers. pp 64 to 76.
- Ministry of the Environment (MOE). 1997. *Noise Assessment Criteria in Land Use Planning*. Publication LU-131. Ontario Ministry of the Environment. 12 pp + Annex.



MOE. 1995. Sound Level Limits for Stationary Sources in Class 1 & 2 Areas (Urban). Publication NPC-205. Ontario Ministry of the Environment. 6 pp + Annex.

MOE. 1995. Sound Level Limits for Stationary Sources in Class 3 Areas (Rural). Publication NPC-232. Ontario Ministry of the Environment. 8 pp + Annex.

NEMA. 2000. Standards Publication No. TR 1-1993 (R2000): Transformers, Regulators and Reactors. National Electrical Manufacturers Association. 31 pp.

ISO 1996-1 Description, Measurement and Assessment of Environmental Noise – Part 1: Basic Quantities and Assessment Procedures.

# **Appendix A**

## **Land-Use Zoning Designation Plan, Area Location Plan and Plant Layout**

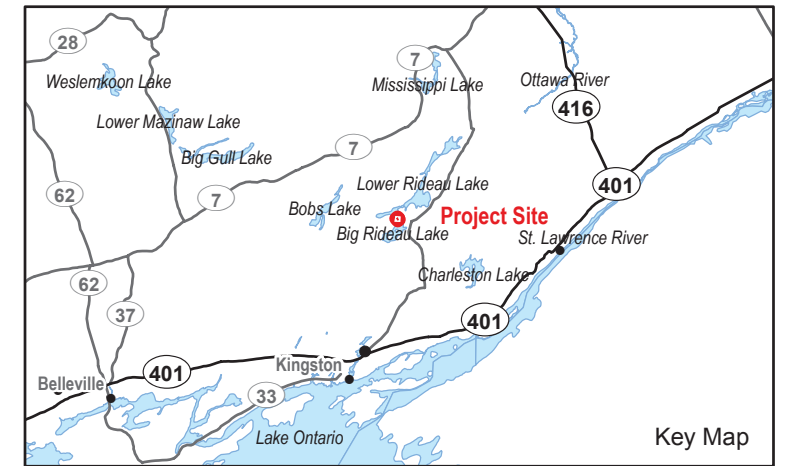
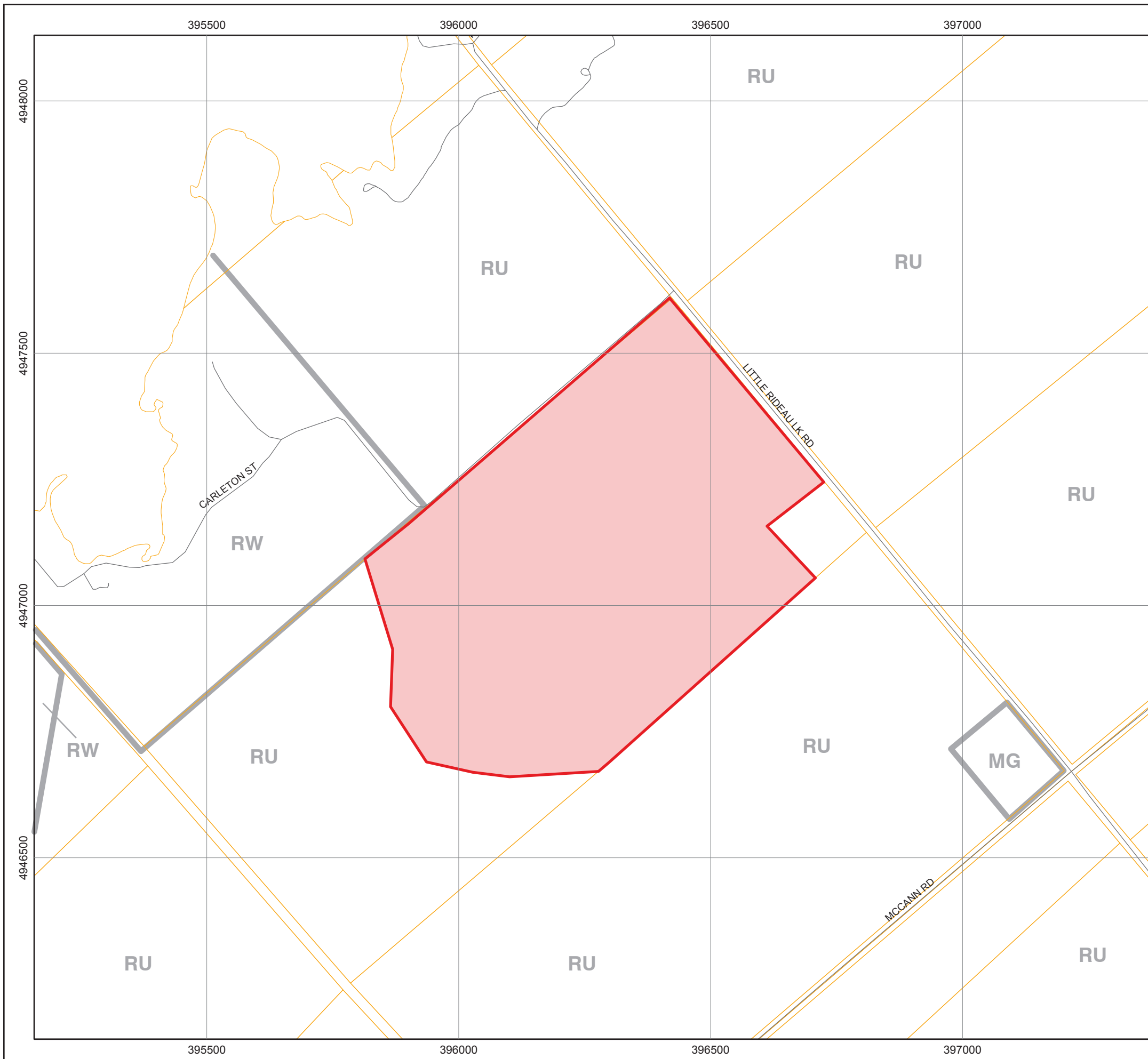

- Zones
- RG General Residential
  - RW Waterfront Residential
  - RMH Mobile Home Park Residential
  - CG General Commercial
  - CL Local Commercial
  - CT Tourist Commercial
  - MG General Industrial
  - MS Salvage Yard Industrial
  - MD Disposal Industrial
  - I Institutional
  - OS Open Space
  - PL Parking Lot
  - RU Rural
  - A Agriculture
  - EX Mineral Aggregate Extraction
  - EP-A Environmental Protection - A
  - EP-B Environmental Protection - B
  - FP Flood Plain
  - Project Site

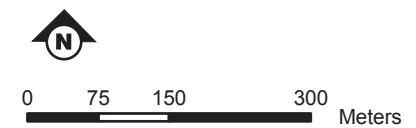

1:8,000  
 Source: Zoning By Law for Township of Rideau Lakes, Schedules A1 & A2

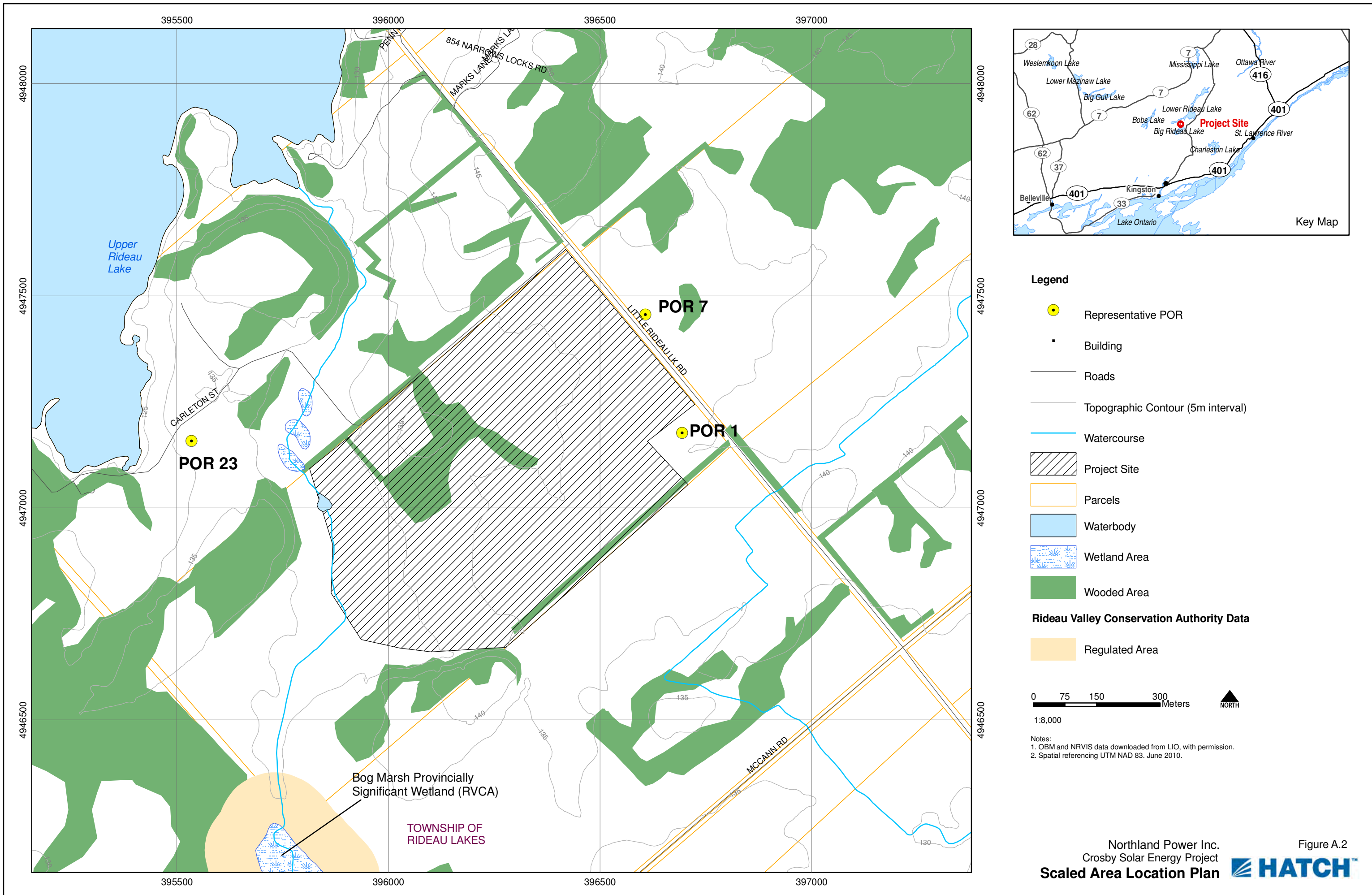

Northland Power Inc.  
 Crosby Solar Energy Project  
**Scaled Area Location Plan** 

Figure A.2



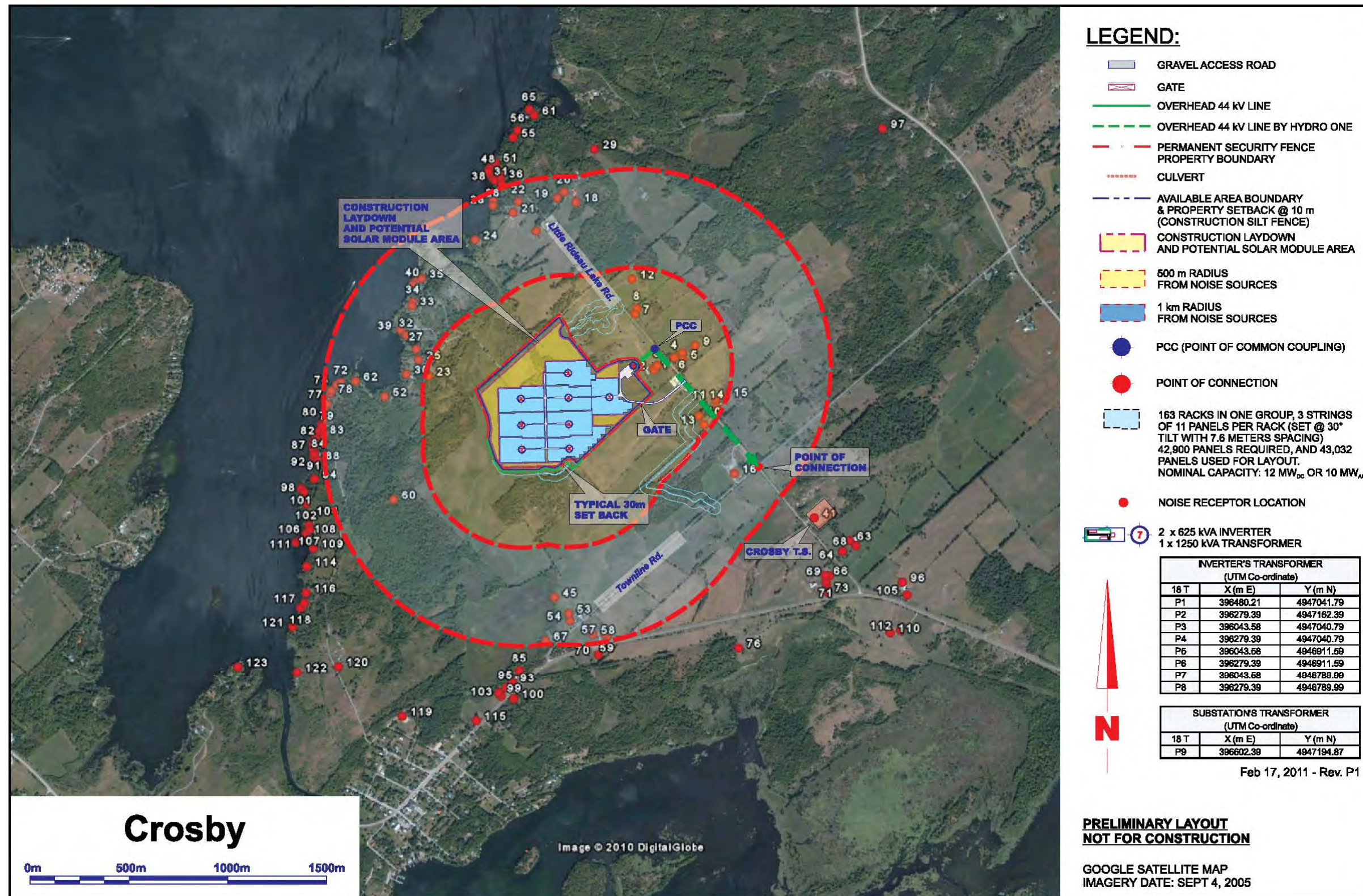

Figure A3 Northland Crosby Layout (provided by Northland Power)



# Appendix B

## Noise Sources

**Table B1 Point Sources Used in CADNA-A, Includes Tonality Penalty of 5 dBA**

Name	Result PWL		Correction		Height (m)	Coordinates		
	Day (dBA)	Night (dBA)	Day (dBA)	Night (dBA)		X (m)	Y (m)	Z (m)
Substation	93.3	93.3	5.0	5.0	3.2	396602	4947195	141.2
Inverter Cluster #1: 10 MVA	102.2	102.2	5.0	5.0	3.5	396480	4947042	139.6
Inverter Cluster #2: 1.25 MW	102.2	102.2	5.0	5.0	3.5	396279	4947162	138.5
Inverter Cluster #3: 1.25 MW	102.2	102.2	5.0	5.0	3.5	396044	4947041	135.8
Inverter Cluster #4: 1.25 MW	102.2	102.2	5.0	5.0	3.5	396279	4947041	138.5
Inverter Cluster #5: 1.25 MW	102.2	102.2	5.0	5.0	3.5	396044	4946912	133.6
Inverter Cluster #6: 1.25 MW	102.2	102.2	5.0	5.0	3.5	396279	4946912	138.5
Inverter Cluster #7: 1.25 MW	102.2	102.2	5.0	5.0	3.5	396044	4946790	133.5
Inverter Cluster #8: 1.25 MW	102.2	102.2	5.0	5.0	3.5	396279	4946790	138.5

**Table B2 Frequency Spectra Use for Modelling the Noise Sources, Not Including Tonality Penalty**

Name	Octave Spectrum (dBA)										
	31.5	63	125	250	500	1000	2000	4000	8000	A	lin
10-MVA Subs. Transformer	45.5	64.7	76.8	79.3	84.7	81.9	78.1	72.9	63.8	88.3	96.9
Inverter 1.25 MW	4.8	64.8	78.9	93.0	91.6	90.1	87.6	79.9	65.4	97.2	103.7

**Table B3 Absorption Coefficient  $\alpha$  for the Barriers**

Name	Octave Spectrum (dBA)										
	31.5	63	125	250	500	1000	2000	4000	8000	Aw	
Barrier	0.00	0.00	0.01	0.05	0.05	0.04	0.04	0.04	0.04	0.00	0.05

**Table B4 Noise Reduction and Sound Transmission Characteristics of the Acoustical Louvers**

Name	Octave Spectrum (dBA)								
	31.5	63	125	250	500	1000	2000	4000	8000
Louver	0.0	0.0	10.0	10.0	12.0	16.0	23.0	18.0	0.0

Blank back





#### Efficient

- Without low-voltage transformer: greater plant efficiency due to direct connection to the medium-voltage grid

#### Turnkey Delivery

- With medium-voltage transformer and concrete substation for outdoor installation

#### Optional

- Medium-voltage switchgear systems for a flexible structure of large solar parks
- AC transfer station with measurement

- Medium-voltage transformers for other grid voltages (deviating from 20 kV)

## SUNNY CENTRAL for Direct medium-voltage feed-in 800MV / 1000MV / 1250MV

High-performance medium-voltage station

For even more power: Two powerful Sunny Central HE inverters are components of a medium-voltage station (MV) which feeds directly into a shared medium-voltage transformer. In this way, for example, two Sunny Central 630HE inverters are combined into a powerful Sunny Central 1250MV station. The advantage: By removing the need for the low-voltage transformer, the plant operator realizes greater yields and at the same time lower inverter costs. The Sunny Central MV is delivered as a "turnkey" concrete substation for outside installation. On top of that, the Sunny Central MV actively participates in grid management, and thereby fulfils all requirements of the Medium-Voltage Directive valid as of July 2010.

# SUNNY CENTRAL 800MV / 1000MV / 1250MV

Technical data	Sunny Central 800MV	Sunny Central 1000MV	Sunny Central 1250MV
<b>Input data</b>			
Nominal DC power	816 kW	1018 kW	1284 kW
Max. DC power	900 kW <sup>1)</sup>	1120 kW <sup>1)</sup>	1410 kW <sup>1)</sup>
MPP voltage range	450 V - 820 V <sup>5)</sup>	450 V - 820 V <sup>5)</sup>	500 V - 820 V <sup>5),7)</sup>
Max. DC voltage	1000 V	1000 V	1000 V
Max. DC current	1986 A	2484 A	2844 A
Number of DC inputs	(16 + 16) + 4 DCHV	(16 + 16) + 4 DCHV	(16 + 16) + 4 DCHV
<b>Output data</b>			
Nominal AC power @ 45 °C	800 kVA	1000 kVA	1250 kVA
Continuous AC power @ 25 °C	880 kVA	1100 kVA	1400 kVA
Nominal AC voltage	20000 V	20000 V	20000 V
Nominal AC current	23.2 A	28.8 A	36.1 A
AC grid frequency 50 Hz	●	●	●
AC grid frequency 60 Hz	●	●	●
Power factor (cos φ)	0.9 leading ... 0.9 lagging		
Max. THD	< 3 %	< 3 %	< 3 %
<b>Power consumption</b>			
Internal consumption in operation	< 3000 W <sup>4)</sup>	< 3000 W <sup>4)</sup>	< 3000 W <sup>4)</sup>
Standby consumption	< 180 W + 1100 W	< 180 W + 1100 W	< 180 W + 1350 W
External auxiliary supply voltage	3 x 230 V, 50/60 Hz	3 x 230 V, 50/60 Hz	3 x 230 V, 50/60 Hz
External back-up fuse for auxiliary supply	B 20 A, 3-pole	B 20 A, 3-pole	B 20 A, 3-pole
<b>Dimensions and weight</b>			
Height	3620 mm	3620 mm	3620 mm
Width	5400 mm	5400 mm	5400 mm
Depth	3000 mm	3000 mm	3000 mm
Weight	35000 kg	35000 kg	35000 kg
<b>Efficiency<sup>2)</sup></b>			
Max. efficiency	97.7 %	97.9 %	97.8 %
Euro-eta	97.3 %	97.5 %	97.4 %
<b>Protection rating and ambient conditions</b>			
Protection rating (as per EN 60529)	IP54	IP54	IP54
Operating temperature range	-20 °C ... +45 °C	-20 °C ... +45 °C	-20 °C ... +45 °C
Rel. humidity	15 % ... 95 %	15 % ... 95 %	15 % ... 95 %
Fresh air consumption	12400 m <sup>3</sup> /h	12400 m <sup>3</sup> /h	12400 m <sup>3</sup> /h
Max. altitude (above sea level)	1000 m	1000 m	1000 m

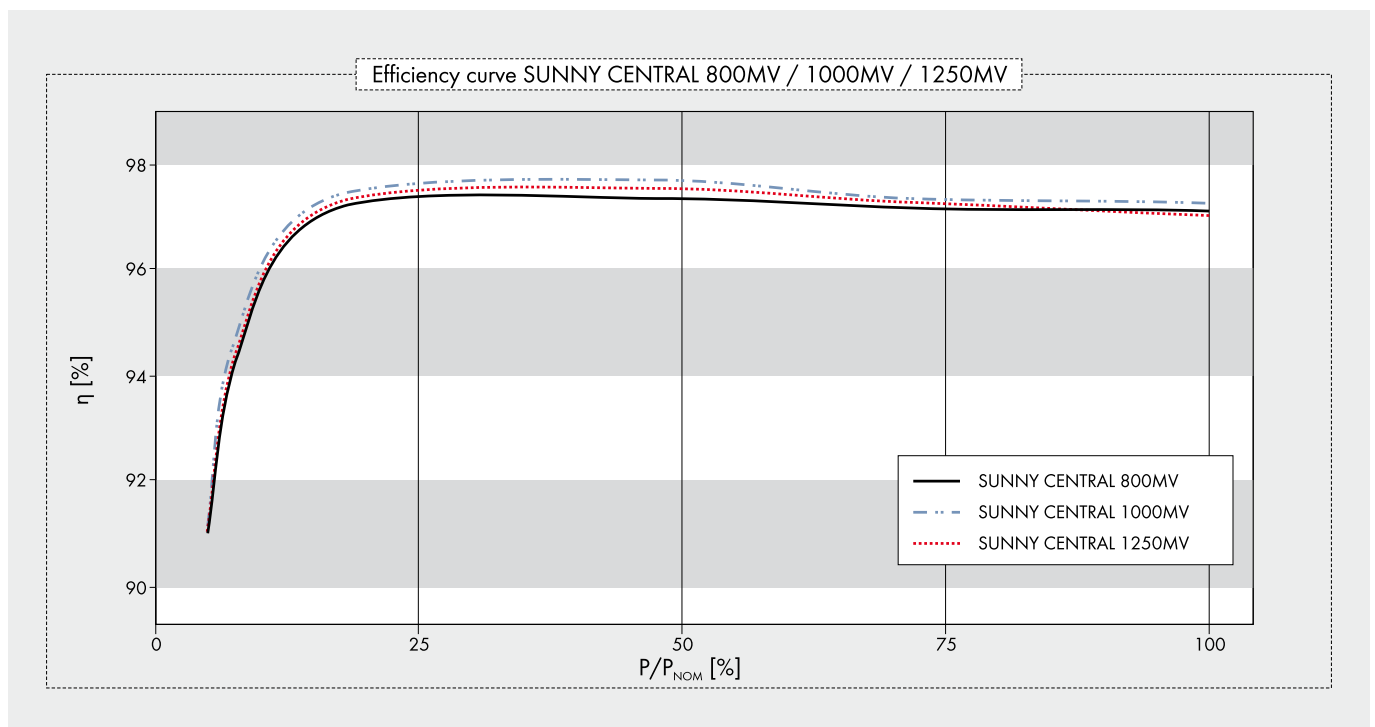

	Sunny Central 800MV	Sunny Central 1000MV	Sunny Central 1250MV
<b>Features</b>			
Display: text line / graphic	●/–	●/–	●/–
Ground fault monitoring	●	●	●
Heating	●	●	●
Emergency stop	●	●	●
Circuit breaker AC side	SI load disconnection switch	SI load disconnection switch	SI load disconnection switch
Circuit breaker DC side	Switch-disconnector with motor	Switch-disconnector with motor	Switch-disconnector with motor
Monitored overvoltage protectors AC / DC	●/●	●/●	●/●
Monitored overvoltage protectors for auxiliary supply	●	●	●
<b>SCC (Sunny Central Control) interfaces</b>			
Communication (NET Piggy-Back, optional)	analog, ISDN, Ethernet	analog, ISDN, Ethernet	analog, ISDN, Ethernet
Analog inputs	10 x A <sub>m</sub> <sup>3)</sup>	10 x A <sub>m</sub> <sup>3)</sup>	10 x A <sub>m</sub> <sup>3)</sup>
Overvoltage protection for analog inputs	○	○	○
Sunny String-Monitor connection (COM1)	RS485	RS485	RS485
PC connection (COM3)	RS232	RS232	RS232
Electrically separated relay (ext. alert signal)	2	2	2
<b>Certificates / listings</b>			
EMC	EN 61000-6-2 EN 61000-6-4		
CE conformity	●	●	●
BDEW-MSRL / FGW / TR8 <sup>6)</sup>	●	●	●
RD 1633 / 2000	●	●	●
Arrêté du 23/04/08	●	●	●
● standard features   ○ optional features   – not available			
Type designation	SC 800MV-11	SC 1000MV-11	SC 1250MV-11

HE: High Efficiency, inverter without galvanic isolation for connection to a medium-voltage transformer (taking into account the SMA specification for the transformer)

1) Specifications apply to irradiation values below STC

2) Efficiency measured without an internal power supply at  $U_{DC} = 500\text{ V}$

3) 2x inputs for the external nominal value specification for active power and reactive power, 1x external alarm input, 1x irradiation sensor, 1x pyranometer

4) Internal consumption at nominal power

5) At  $1.05 U_{AC, nom}$  and  $\cos \varphi = 1$

6) With limited dynamic grid support

7) At  $f_{grid} = 60\text{ Hz}$ : 510 V - 820 V

**Please note:** in certain countries the substations may differ from the substations shown in the images

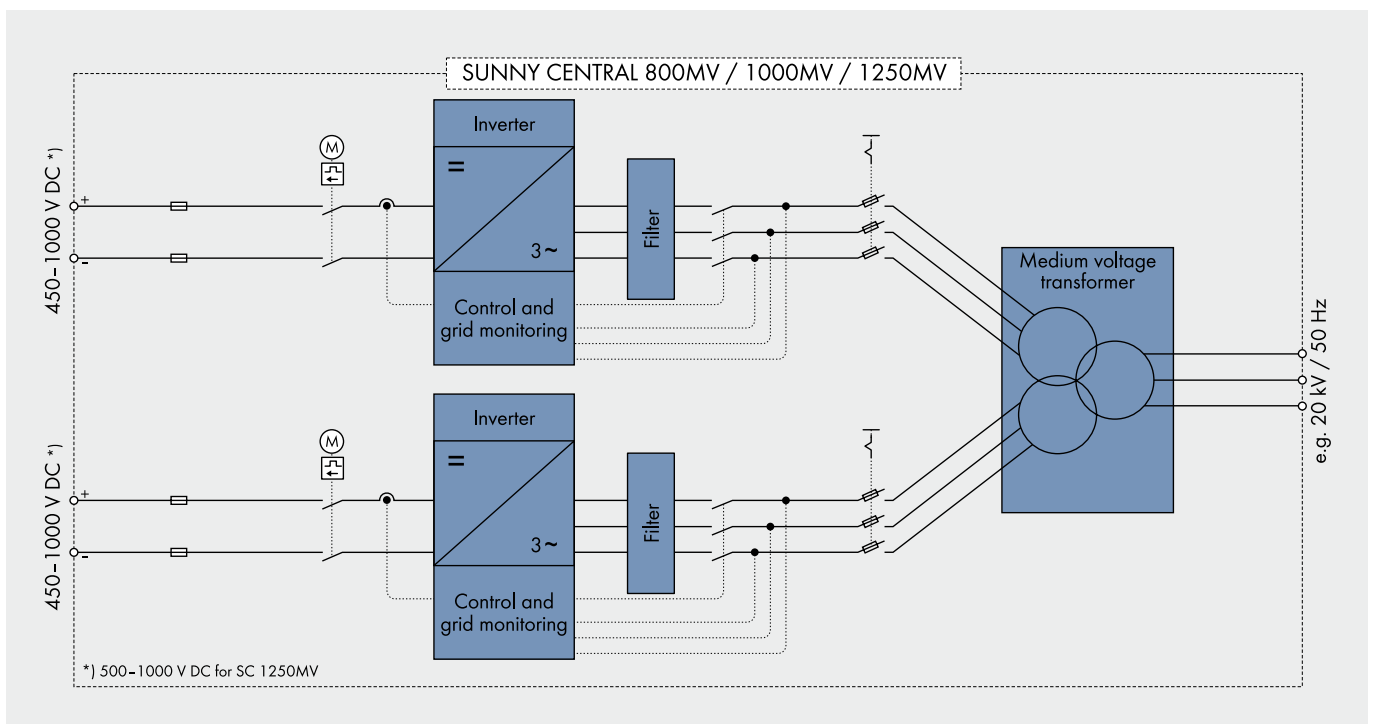

# POWERFUL GRID MANAGEMENT FUNCTIONS

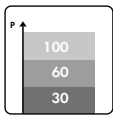

## Remote controlled power reduction in case of grid overload

In order to avoid short-term grid overload, the grid operator presets a nominal active power value which the inverter will implement within 60 seconds. The nominal value is transmitted to the inverters via a ripple control receiver in combination with the SMA Power Reducer Box. Typical limit values are 100, 60, 30 or 0 per cent of the nominal power.

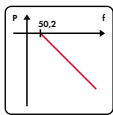

## Frequency-dependent control of active power

As of a grid frequency of 50.2 Hz, the inverter automatically reduces the fed-in of active power according to a definable characteristic curve which thereby contributes to the stabilization of the grid frequency.

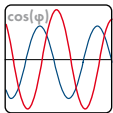

## Static voltage support based on reactive power

To stabilize the grid voltage, SMA inverters feed reactive power (leading or lagging) into the grid. Three different modes are available:

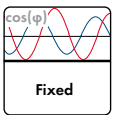

### a) Fixed definition of the reactive power by the grid operator

The grid operator defines a fixed reactive power value or a fixed displacement factor between  $\cos(\varphi)_{\text{leading}} = 0.90$  and  $\cos(\varphi)_{\text{lagging}} = 0.90$ .

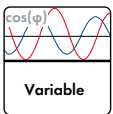

### b) Definition of a dynamic setpoint of the reactive power by the utility operator

The grid operator defines a dynamic displacement factor - any value between  $\cos(\varphi)_{\text{leading}} = 0.90$  and  $\cos(\varphi)_{\text{lagging}} = 0.90$ . It is transmitted either through a communication unit the evaluation can e.g. be evaluated and processed by the SMA Power Reducer Box.

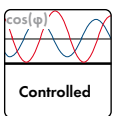

### c) Control of the reactive power over a characteristic curve

The reactive power or the phase shift is controlled by a pre-defined characteristic curve - depending on the active power fed into the grid or the grid voltage.

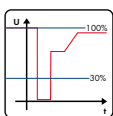

## Limited Dynamic Grid Support

The inverter continues to feed to the grid after short term voltage drops - as long as the grid voltage is within a defined voltage window.

SMA Solar Technologie Umrichteranlage Sunny Central SC 1000MV  
 Betrieb bei Nennleistung und 50 Hz; 1000 KW

A - bewerteter Schalleistungspegel LwA re 1 pW [dB(A)]

**IPK**

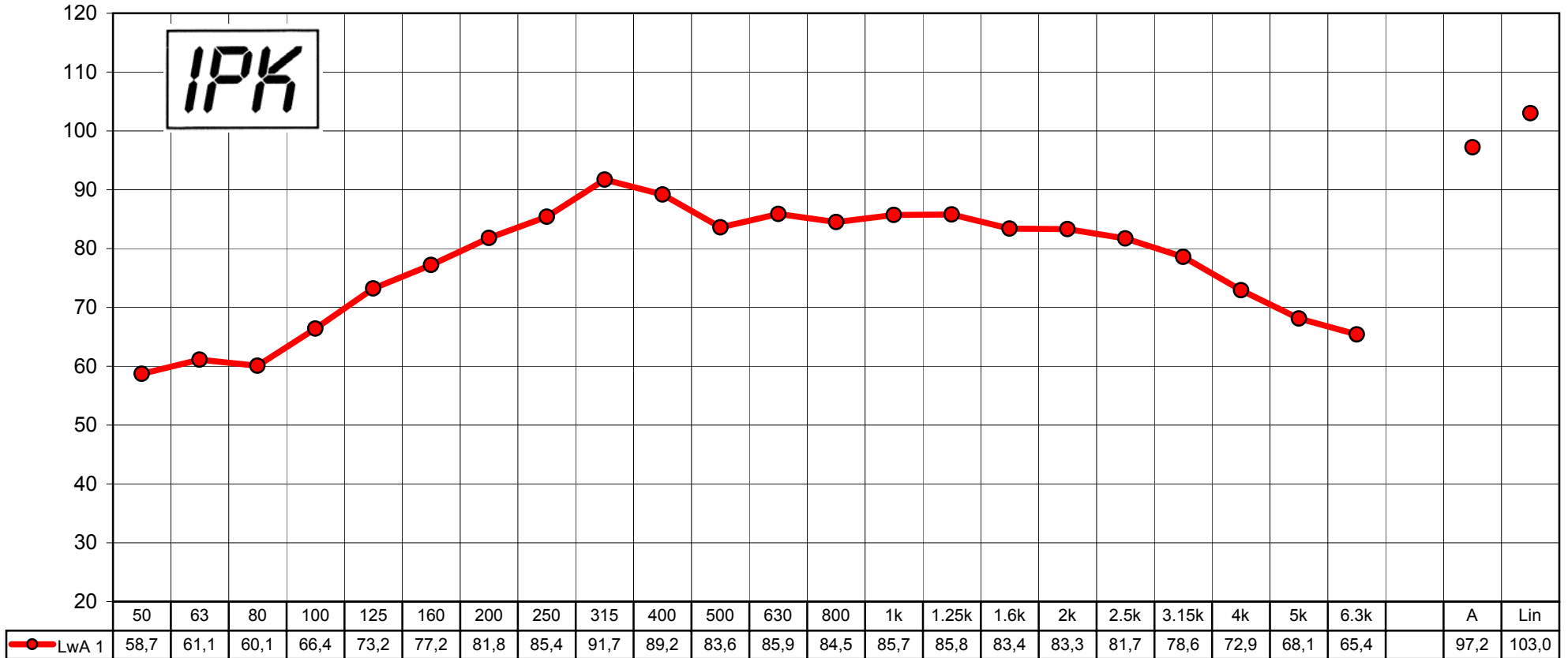

Terz - Mittenfrequenz [Hz]

**From:** Janos Rajda [mailto:Janos.Rajda@sma-america.com]  
**Sent:** Monday, October 18, 2010 9:38 AM  
**To:** Moran, Joaquin  
**Cc:** Mike Lord; Chris Rytel; Elie Nasr  
**Subject:** RE: Noise Levels - U R G E N T

Hi Joaquin,

Yes it will apply as two (2) 625kW, 60Hz are complete mechanical equivalents to two (2) 500kW, 50Hz or to a 1000kW 2-units system. The slight electrical difference between the two units relate to minimum DC voltage rating and grid frequency the units are connected to with no significant impact on levels of unit parts audio noise generation.

Regards,

Janos

---

**From:** Moran, Joaquin [mailto:JMoran@Hatch.ca]  
**Sent:** October-18-10 9:13 AM  
**To:** Janos Rajda  
**Cc:** Mike Lord; Chris Rytel; Elie Nasr  
**Subject:** RE: Noise Levels - U R G E N T

Hi Janos,

Thanks for the information. Just to clarify, the sound power levels provided seem to be for a 1000 kW unit, 50 Hz. Will these apply to the units to be deployed in this case (625 kW, 60 Hz)?

Cheers,

Joaquin

---

**Joaquin E. Moran**  
Tel. +1 905 374-0701 x 5236

---

**From:** Janos Rajda [mailto:Janos.Rajda@sma-america.com]  
**Sent:** Sunday, October 17, 2010 11:22 PM  
**To:** Moran, Joaquin  
**Cc:** Mike Lord; Chris Rytel; Elie Nasr  
**Subject:** RE: Noise Levels - U R G E N T

Hi Joaquin,

Over the weekend we obtained third octave sound power levels for 100% or rated loading case for two SC units as supplied at the time for FirstSolar project in Sarnia.

Thanks again for providing as with sample data, which proved to be helpful in communicating the sound power level format requirement.

Best regards,

Janos

## Acoustical Louver J Blade

### Application and Design

AFJ-601 is an acoustical weather louver designed to protect air intake and exhaust openings in building exterior walls. Design incorporates J style insulated acoustical blades and high free area to provide maximum resistance to sound transmission, rain and weather while providing minimum resistance to airflow. The AFJ-601 is an extremely efficient louver with **AMCA LICENSED PERFORMANCE DATA** enabling designers to select and apply with confidence.

### Standard Construction

- Frame** . . . . . Heavy gauge formed aluminum,  
6 in. x 0.080 in. nominal wall thickness
- Blades** . . . . . J style, heavy gauge formed aluminum,  
0.080 in. nominal wall thickness, positioned  
at 45° on approximately 5 in. centers
- Construction** . . . Mechanically fastened
- Acoustical  
Insulation** . . . . . Fiberglass Insulation
- Birdscreen** . . . . . 3/4 in. x 0.051 flattened expanded aluminum in  
removable frame, inside mount (rear)
- Finish** . . . . . Mill
- Minimum Size** . . 12 in. W x 15 in. H
- Maximum Single  
Section Size** . . . 60 in. W x 120 in. H

### Options (at additional cost)

- A variety of bird and insect screens
- Blank off panels
- Clip angles
- Extended sill
- Filter racks
- Flanged frame
- Galvanized steel frame and blade
- Security bars
- A variety of architectural finishes including:
  - Clear anodize
  - Integral color anodize
  - Baked enamel paint
  - Kynar paint

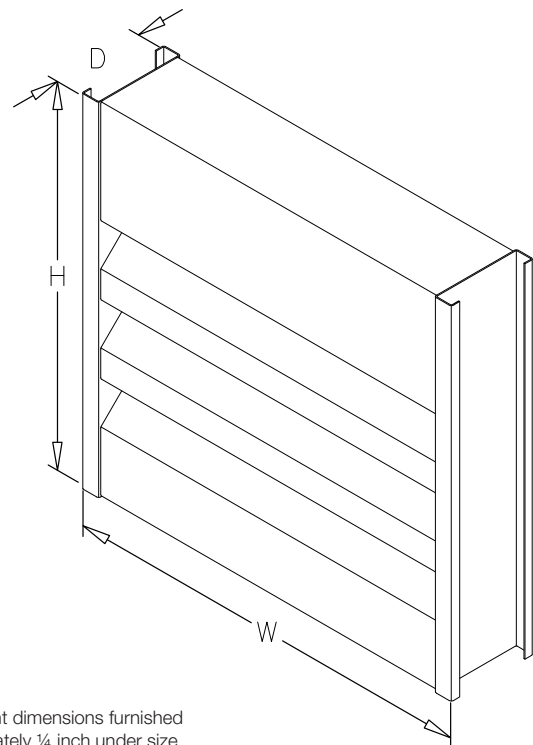
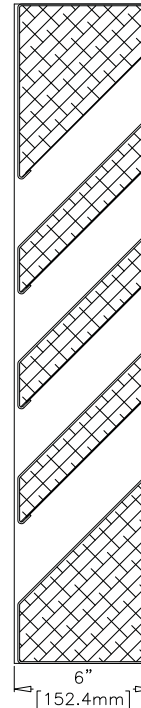

\*Width and height dimensions furnished approximately 1/4 inch under size.

# PERFORMANCE DATA

# AFJ-601

## Free Area Chart (Sq. ft.)

## J Blade Acoustical Louver Formed Aluminum

Louver Height Inches	Louver Width Inches								
	12	18	24	30	36	42	48	54	60
15	0.12	0.21	0.29	0.37	0.45	0.53	0.61	0.69	0.77
18	0.25	0.41	0.57	0.74	0.90	1.06	1.22	1.38	1.55
24	0.37	0.62	0.86	1.10	1.35	1.59	1.83	2.08	2.32
30	0.50	0.82	1.15	1.47	1.80	2.12	2.44	2.77	3.09
36	0.62	1.03	1.43	1.84	2.24	2.65	3.05	3.46	3.86
42	0.75	1.24	1.72	2.21	2.69	3.18	3.67	4.15	4.64
48	1.00	1.65	2.30	2.94	3.59	4.24	4.89	5.54	6.18
54	1.12	1.85	2.58	3.31	4.04	4.77	5.50	6.23	6.96
60	1.25	2.06	2.87	3.68	4.49	5.30	6.11	6.92	7.73
66	1.37	2.26	3.16	4.05	4.94	5.83	6.72	7.61	8.50
72	1.50	2.47	3.44	4.41	5.39	6.36	7.33	8.30	9.27
78	1.75	2.88	4.02	5.15	6.28	7.42	8.55	9.69	10.82
84	1.87	3.09	4.30	5.52	6.73	7.95	9.16	10.38	11.59
90	2.00	3.29	4.59	5.89	7.18	8.48	9.77	11.07	12.37
96	2.12	3.50	4.88	6.25	7.63	9.01	10.38	11.76	13.14
102	2.25	3.71	5.16	6.62	8.08	9.54	11.00	12.45	13.91
108	2.50	4.12	5.74	7.36	8.98	10.60	12.22	13.84	15.46
114	2.62	4.32	6.02	7.73	9.43	11.13	12.83	14.53	16.23
120	2.75	4.53	6.31	8.09	9.88	11.66	13.44	15.22	17.00



Greenheck Fan Corporation certifies that the AFJ-601 louvers shown herein are licensed to bear the AMCA Seal. The ratings shown are based on tests and procedures performed in accordance with AMCA Publication 511 and comply with the requirements of the AMCA Certified Ratings Program. The AMCA Certified Ratings Seal applies to water penetration, air performance and sound ratings.

## Sound Transmission Class

The Sound Transmission Class (STC) is a rating of the effectiveness of an assembly in isolating or reducing airborne sound transmission. STC is a single number that summarizes airborne sound transmission loss data. Assemblies with higher STC ratings are more efficient at reducing sound transmission. STC is determined in accordance with ASTM E413-04.

## Transmission Loss

Transmission loss (TL) is a measurement of the reduction of sound power transmission (dB) through an assembly at a given frequency. The more sound power that is reduced, the greater the TL. TL is tested in accordance with ASTM E90-04.

## Free Field Noise Reduction in Decibels

Free Field Noise Reduction is determined by adding 6 dB to the Transmission Loss.

Octave Band	2	3	4	5	6	7	STC
Frequency (Hz)	63	125	250	500	1000	2000	10
Transmission Loss (dB)	4	4	6	10	17	12	
Free Field Noise Reduction (dB)	10	10	12	16	23	18	

## Airflow Resistance (Standard Air - .075 lb/ft<sup>3</sup>)

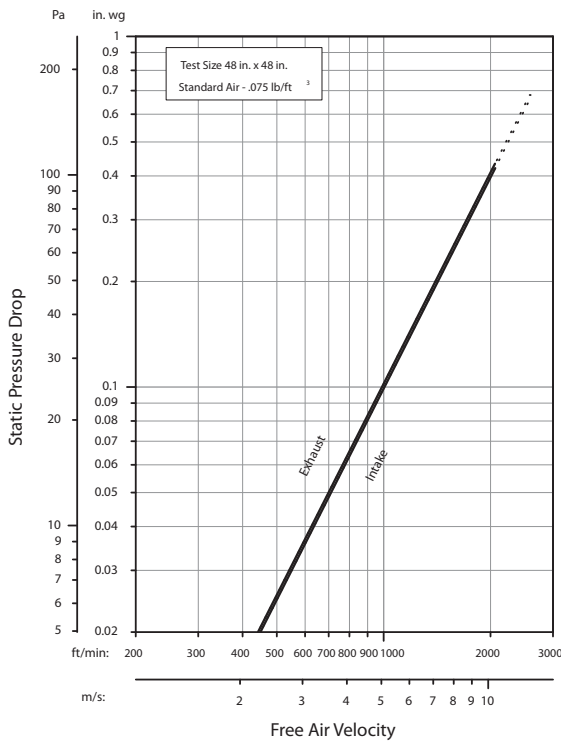

## Water Penetration (Standard Air - .075 lb/ft<sup>3</sup>)

Test size 48 in. x 48 in. Test duration of 15 min.

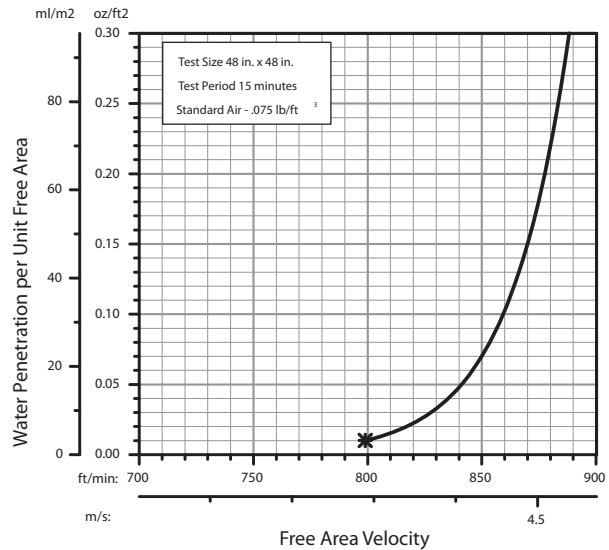

Model AFJ-601 resistance to airflow (pressure drop) varies depending on louver application (air intake or air exhaust). Free area velocities (shown) are higher than average velocity through the overall louver size. See louver selection information.

The AMCA Water Penetration Test provides a method for comparing various louver models and designs as to their efficiency in resisting the penetration of rainfall under specific laboratory test conditions. The beginning point of water penetration is defined as that velocity where the water penetration curve projects through .01 oz. of water (penetration) per sq. ft. of louver free area. **\*The beginning point of water penetration for Model AFJ-601 is 799 fpm free area velocity.** These performance ratings do not guarantee a louver to be weatherproof or stormproof and should be used in combination with other factors including good engineering judgement in selecting louvers.





# INSTALLATION DETAILS

# AFJ-601

## Maximum Size and Installation Information

J Blade Acoustical Louver  
Formed Aluminum

Maximum single section size for model AFJ-601 is 60 in. W x 120 in. H. Larger openings require field assembly of multiple louver panels to make up the overall opening size. Individual louver panels are designed to withstand a 25 PSF wind-load (please consult Greenheck if the louvers must withstand higher wind-loads). Structural reinforcing members may be required to adequately support and install multiple louver panels within a large opening. Structural reinforcing members along with any associated installation hardware is not provided by Greenheck unless indicated otherwise by Greenheck. Additional information on louver installation may be found in AMCA Publication #501, Louver Application Manual.

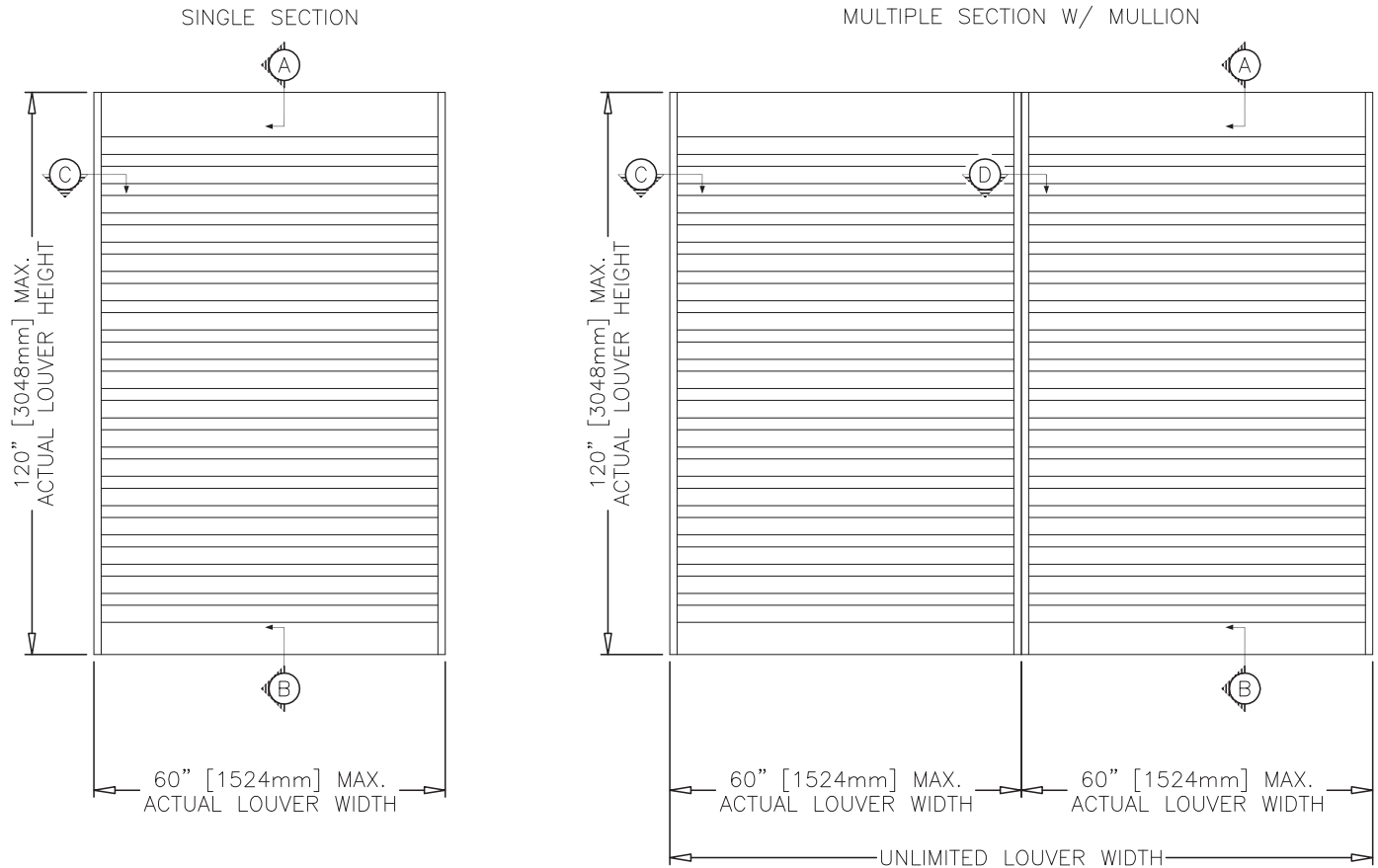

**Minimum Single Section Size**  
12 in. W x 15 in. H

**Maximum Single Section Size**  
60 in. W x 120 in. H

# PRODUCT DETAILS

# AFJ-601

J Blade Acoustical Louver  
Formed Aluminum

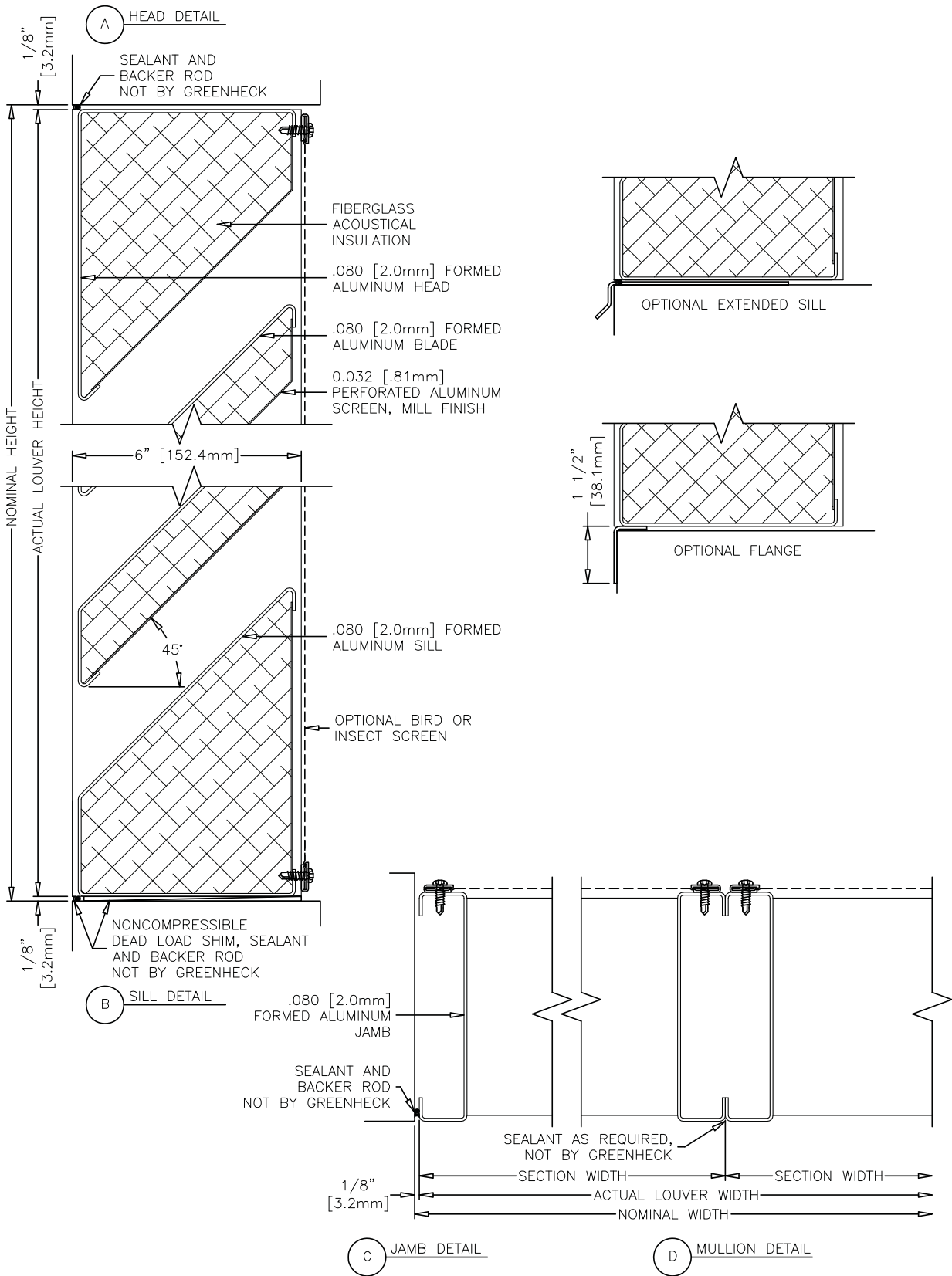

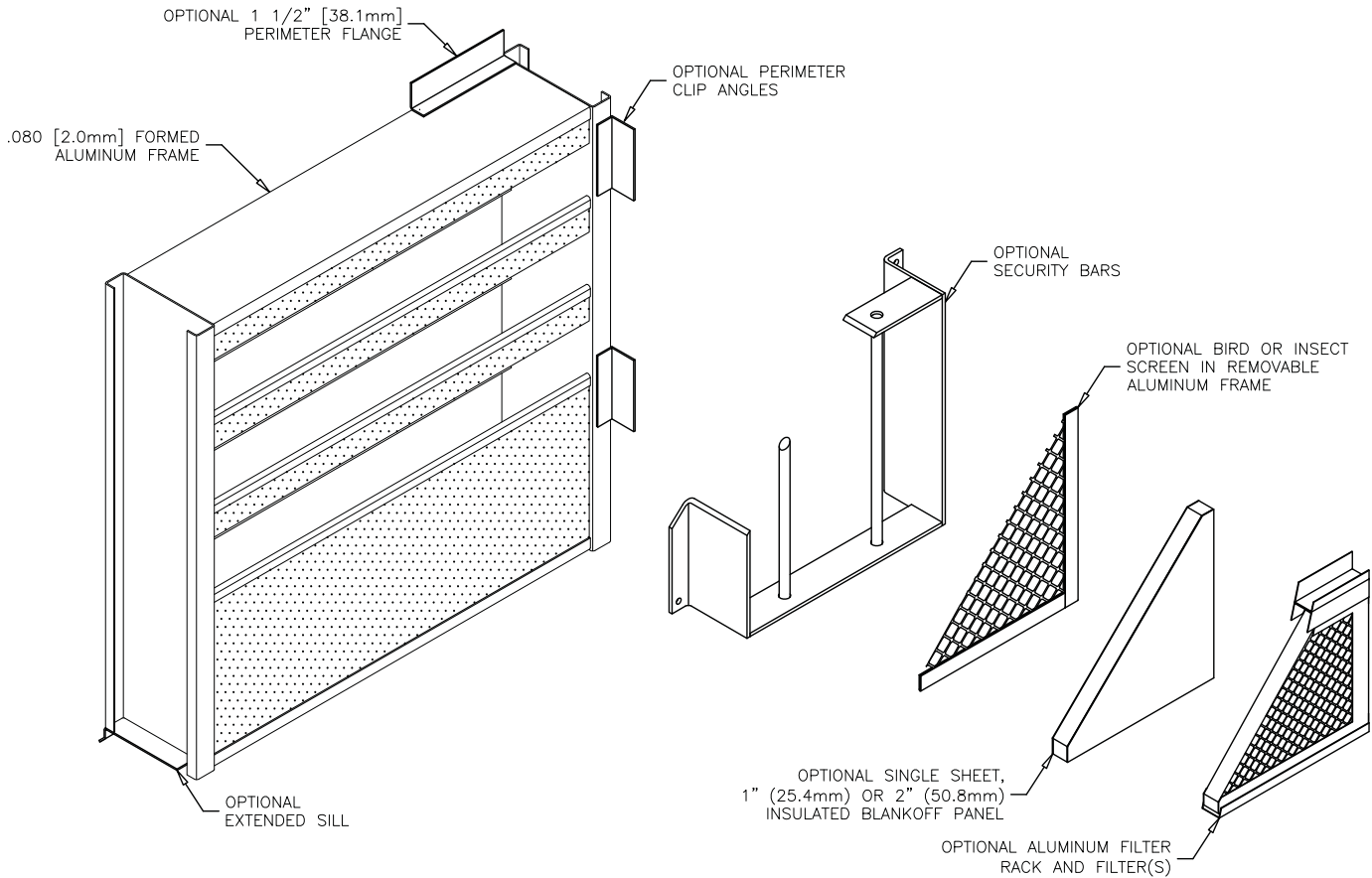

## FINISHES

Finish Type	Description/Application	Color Selection	Standard Warranty (Aluminum)
2-coat 70% KYNAR 500®/HYLAR 5000® AAMA 2605 – Dry film thickness 1.2 mil. (AKA: Duranar®, Fluoropon®, Trinar®, Flouropolymer, Polyvinylidene Fluoride, PVDF2)	<b>“Best.”</b> The premier finish for extruded aluminum. Tough, long-lasting coating has superior color retention and abrasive properties. Resists chalking, fading, chemical abrasion and weathering.	<b>Standard Colors:</b> Any of the 24 standard colors shown can be furnished in 70% or 50% KYNAR 500®/HYLAR 5000® or Baked Enamel.  <b>2-Coat Mica:</b> Greenheck offers 9 standard 2-coat Mica colors. Other colors are available. Consult Greenheck for possible extra cost when selecting non-standard colors or special finishes.	10 Years (Consult Greenheck for availability of extended warranty)
2-coat 50% KYNAR 500®/HYLAR 5000® AAMA 2604 – Dry film thickness 1.2 mil. (AKA: Acroflur®, Acrynar®)	<b>“Better.”</b> Tough, long-lasting coating has excellent color retention and abrasive properties. Resists chalking, fading, chemical abrasion and weathering.		5 Years
Baked Enamel AAMA 2603 – Dry film thickness 0.8 mil. (AKA: Acrabond Plus®, Duracron®)	<b>“Good.”</b> Provides good adhesion and resistance to weathering, corrosion and chemical stain.		1 Year
Integral Color Anodize AA-M10C22A42 (>0.7 mil)	“Two-step” anodizing is produced by following the normal anodizing step with a second, colorfast process.	Light, Medium or Dark Bronze; Champagne; Black	5 years
Clear Anodize 215 R-1 AA-M10C22A41 (>0.7 mil)	Clear, colorless and hard oxide aluminum coating that resists weathering and chemical attack.	Clear	5 years
Clear Anodize 204 R-1 AA-M10C22A31 (0.4-0.7 mil)	Clear, colorless and hard oxide aluminum coating that resists weathering and chemical attack.	Clear	1 Year
Industrial coatings	Greenheck offers a number of industrial coatings such as Hi-Pro Polyester, Epoxy, and Permator®. Consult a Greenheck Product Specialist for complete color and application information.		Consult Greenheck
Mill	Materials may be supplied in natural aluminum or galvanized steel finish when normal weathering is acceptable and there is no concern for color or color change.		n/a

Finishes meet or exceed AAMA 2605, AAMA 2604, and AAMA 2603 requirements. Please consult [www.greenheck.com](http://www.greenheck.com) for complete information on standard and extended paint warranties. Paint finish warranties are not applicable to steel products.



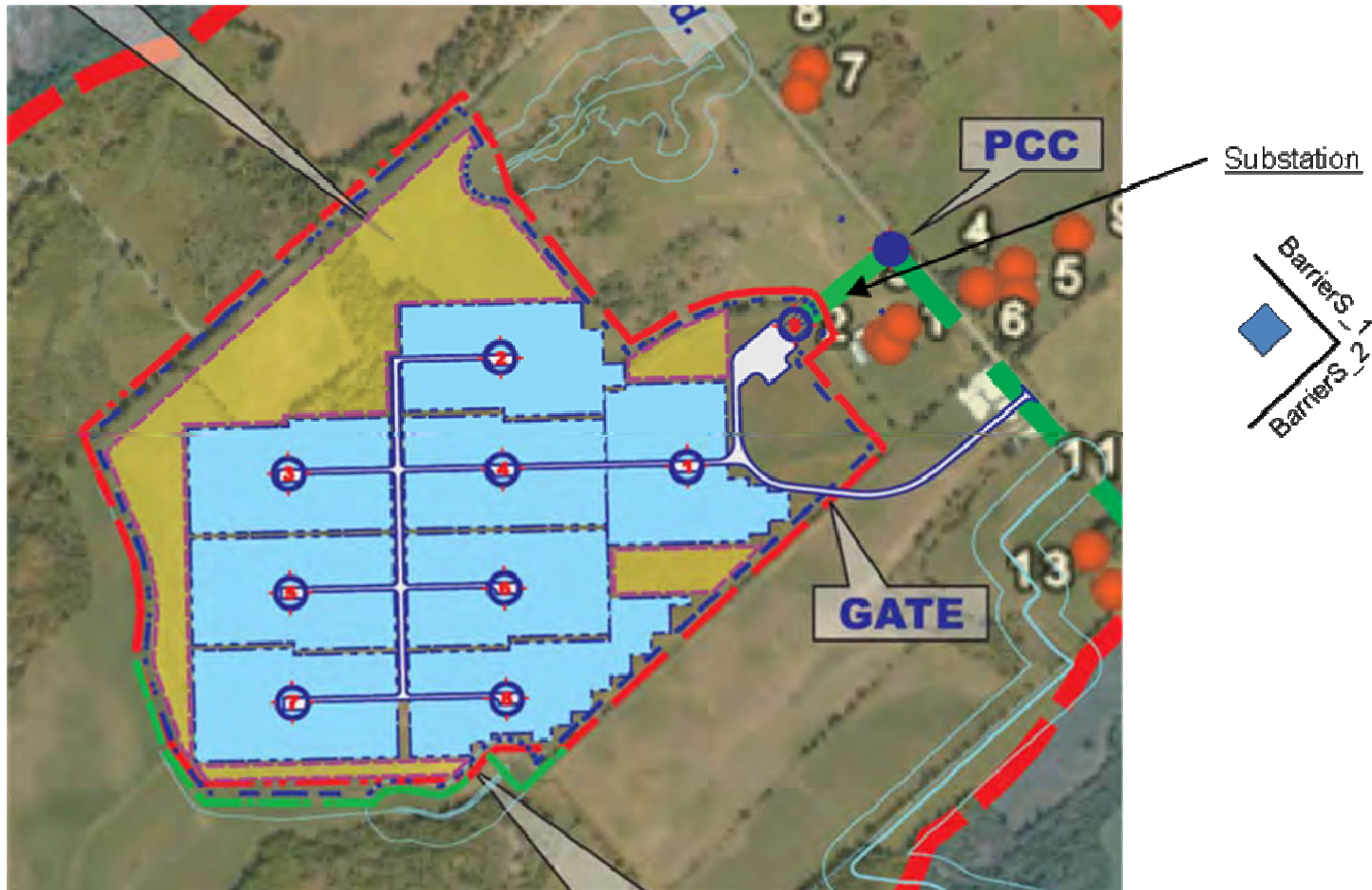

Figure B1 Location and ID of Proposed Sound Barriers

# **Appendix C**

## **Sound Pressure Levels for Points of Reception, Noise Maps from CADNA-A**

**Table C1 Sound Pressure Levels for POR (shaded rows correspond to representative POR)**

ID	Level Lp		Limit. Value		Noise Type	Height (m)	Coordinates		
	Day (dBA)	Night (dBA)	Day (dBA)	Night (dBA)			X (m)	Y (m)	Z (m)
1	35.7	35.7	45.0	40.0	Total	4.5	396693	4947179	143.9
2	35.4	35.4	45.0	40.0	Total	4.5	396699	4947172	144.1
3	34.5	34.5	45.0	40.0	Total	4.5	396713	4947194	144.1
4	31.1	31.1	45.0	40.0	Total	4.5	396802	4947234	144.5
5	29.3	29.3	45.0	40.0	Total	4.5	396845	4947224	144.5
6	29.9	29.9	45.0	40.0	Total	4.5	396843	4947256	144.5
7	32.6	32.6	45.0	40.0	Total	4.5	396605	4947458	143.1
8	31.9	31.9	45.0	40.0	Total	4.5	396616	4947485	143.5
9	27.1	27.1	45.0	40.0	Total	4.5	396908	4947292	144.5
10	28.7	28.7	45.0	40.0	Total	4.5	396921	4946935	142.9
11	27.5	27.5	45.0	40.0	Total	4.5	397006	4947019	144.5
12	29.8	29.8	45.0	40.0	Total	4.5	396594	4947635	144.5
13	28.2	28.2	45.0	40.0	Total	4.5	396946	4946892	142.7
14	27.4	27.4	45.0	40.0	Total	4.5	397014	4946979	144.5
15	26.6	26.6	45.0	40.0	Total	4.5	397057	4947029	144.5
16	24.6	24.6	45.0	40.0	Total	4.5	397096	4946640	139.5
17	26.3	26.3	45.0	40.0	Total	4.5	396110	4947887	146.7
18	25.7	25.7	45.0	40.0	Total	4.5	396315	4948030	152.7
19	22.8	22.8	45.0	40.0	Total	4.5	396220	4948053	149.5
20	22.5	22.5	45.0	40.0	Total	4.5	396255	4948083	150.3
21	23.2	23.2	45.0	40.0	Total	4.5	395995	4947982	139.8
22	22.1	22.1	45.0	40.0	Total	4.5	396023	4948037	140.3
23	29.7	29.7	45.0	40.0	Total	4.5	395553	4947160	136.1
24	23.0	23.0	45.0	40.0	Total	4.5	395800	4947848	129.5
25	27.8	27.8	45.0	40.0	Total	4.5	395503	4947243	136.8
26	21.8	21.8	45.0	40.0	Total	4.5	395893	4948021	129.5
27	24.9	24.9	45.0	40.0	Total	4.5	395492	4947297	135.3
28	21.6	21.6	45.0	40.0	Total	4.5	395896	4948048	129.6
29	19.2	19.2	45.0	40.0	Total	4.5	396414	4948298	145.1
30	24.8	24.8	45.0	40.0	Total	4.5	395440	4947171	130.8
31	21.0	21.0	45.0	40.0	Total	4.5	395939	4948130	132.9
32	23.9	23.9	45.0	40.0	Total	4.5	395443	4947368	130.3
33	23.3	23.3	45.0	40.0	Total	4.5	395474	4947518	134.5
34	23.2	23.2	45.0	40.0	Total	4.5	395479	4947537	134.7
35	22.8	22.8	45.0	40.0	Total	4.5	395524	4947656	132.3
36	20.8	20.8	45.0	40.0	Total	4.5	395935	4948157	131.9
37	22.7	22.7	45.0	40.0	Total	4.5	395505	4947654	131.6
38	20.8	20.8	45.0	40.0	Total	4.5	395904	4948147	129.5
39	23.5	23.5	45.0	40.0	Total	4.5	395415	4947396	129.5
40	22.7	22.7	45.0	40.0	Total	4.5	395479	4947624	130.9
41	19.0	19.0	45.0	40.0	Total	4.5	397499	4946409	134.5
42	20.6	20.6	45.0	40.0	Total	4.5	395940	4948187	133.8
43	20.7	20.7	45.0	40.0	Total	4.5	395896	4948158	129.5
44	20.6	20.6	45.0	40.0	Total	4.5	395887	4948171	130.4
45	23.5	23.5	45.0	40.0	Total	4.5	396174	4946027	137.2
46	20.5	20.5	45.0	40.0	Total	4.5	395880	4948181	130.4

ID	Level Lp		Limit. Value		Noise Type	Height (m)	Coordinates		
	Day (dBA)	Night (dBA)	Day (dBA)	Night (dBA)			X (m)	Y (m)	Z (m)
47	20.3	20.3	45.0	40.0	Total	4.5	395914	4948211	134.5
48	20.4	20.4	45.0	40.0	Total	4.5	395873	4948193	130.5
49	20.3	20.3	45.0	40.0	Total	4.5	395879	4948207	133.0
50	20.2	20.2	45.0	40.0	Total	4.5	395891	4948225	134.5
51	20.1	20.1	45.0	40.0	Total	4.5	395908	4948239	134.5
52	23.8	23.8	45.0	40.0	Total	4.5	395328	4947059	130.5
53	22.5	22.5	45.0	40.0	Total	4.5	396245	4945943	136.8
54	22.1	22.1	45.0	40.0	Total	4.5	396251	4945907	136.4
55	19.3	19.3	45.0	40.0	Total	4.5	396002	4948363	136.4
56	19.1	19.1	45.0	40.0	Total	4.5	396026	4948399	135.8
57	21.2	21.2	45.0	40.0	Total	4.5	396426	4945837	136.9
58	21.1	21.1	45.0	40.0	Total	4.5	396365	4945835	136.5
59	21.1	21.1	45.0	40.0	Total	4.5	396438	4945825	137.0
60	27.0	27.0	45.0	40.0	Total	4.5	395365	4946536	139.5
61	18.7	18.7	45.0	40.0	Total	4.5	396110	4948475	132.2
62	22.2	22.2	45.0	40.0	Total	4.5	395181	4947140	129.5
63	17.5	17.5	45.0	40.0	Total	4.5	397674	4946290	130.9
64	17.6	17.6	45.0	40.0	Total	4.5	397639	4946237	130.2
65	18.4	18.4	45.0	40.0	Total	4.5	396086	4948505	130.8
66	17.7	17.7	45.0	40.0	Total	4.5	397551	4946116	129.5
67	22.2	22.2	45.0	40.0	Total	4.5	396125	4945807	138.7
68	17.3	17.3	45.0	40.0	Total	4.5	397708	4946264	129.9
69	17.5	17.5	45.0	40.0	Total	4.5	397572	4946113	129.5
70	20.2	20.2	45.0	40.0	Total	4.5	396392	4945732	135.2
71	17.5	17.5	45.0	40.0	Total	4.5	397554	4946085	129.5
72	21.6	21.6	45.0	40.0	Total	4.5	395108	4947134	129.5
73	17.5	17.5	45.0	40.0	Total	4.5	397556	4946071	129.5
74	21.4	21.4	45.0	40.0	Total	4.5	395088	4947125	129.5
75	17.3	17.3	45.0	40.0	Total	4.5	397564	4946027	129.5
76	17.9	17.9	45.0	40.0	Total	4.5	397104	4945754	131.1
77	21.1	21.1	45.0	40.0	Total	4.5	395057	4947093	129.5
78	21.0	21.0	45.0	40.0	Total	4.5	395052	4947080	129.5
79	20.9	20.9	45.0	40.0	Total	4.5	395035	4947026	129.5
80	20.8	20.8	45.0	40.0	Total	4.5	395026	4946984	129.7
81	20.7	20.7	45.0	40.0	Total	4.5	395013	4946940	129.5
82	20.7	20.7	45.0	40.0	Total	4.5	395015	4946869	131.1
83	20.6	20.6	45.0	40.0	Total	4.5	395006	4946914	129.5
84	20.5	20.5	45.0	40.0	Total	4.5	394991	4946886	129.5
85	20.8	20.8	45.0	40.0	Total	4.5	395991	4945658	139.5
86	20.3	20.3	45.0	40.0	Total	4.5	394975	4946859	129.5
87	20.2	20.2	45.0	40.0	Total	4.5	394968	4946838	129.5
88	20.3	20.3	45.0	40.0	Total	4.5	394982	4946742	130.5
89	20.2	20.2	45.0	40.0	Total	4.5	394960	4946823	129.5
90	20.2	20.2	45.0	40.0	Total	4.5	394962	4946797	129.5
91	20.2	20.2	45.0	40.0	Total	4.5	394966	4946773	129.7
92	20.1	20.1	45.0	40.0	Total	4.5	394965	4946753	129.7
93	19.8	19.8	45.0	40.0	Total	4.5	395952	4945598	139.5



ID	Level Lp		Limit. Value		Noise Type	Height (m)	Coordinates		
	Day (dBA)	Night (dBA)	Day (dBA)	Night (dBA)			X (m)	Y (m)	Z (m)
94	20.0	20.0	45.0	40.0	Total	4.5	394965	4946647	130.3
95	19.5	19.5	45.0	40.0	Total	4.5	395919	4945571	139.5
96	14.1	14.1	45.0	40.0	Total	4.5	397941	4946075	134.5
97	8.1	8.1	45.0	40.0	Total	4.5	397876	4948377	145.8
98	19.4	19.4	45.0	40.0	Total	4.5	394911	4946582	129.5
99	19.3	19.3	45.0	40.0	Total	4.5	395884	4945545	139.5
100	19.7	19.7	45.0	40.0	Total	4.5	395959	4945514	139.5
101	19.3	19.3	45.0	40.0	Total	4.5	394897	4946599	129.5
102	19.3	19.3	45.0	40.0	Total	4.5	394922	4946522	129.8
103	19.2	19.2	45.0	40.0	Total	4.5	395896	4945528	139.5
104	19.3	19.3	45.0	40.0	Total	4.5	394931	4946462	130.2
105	13.1	13.1	45.0	40.0	Total	4.5	397964	4946010	134.5
106	19.1	19.1	45.0	40.0	Total	4.5	394933	4946411	130.0
107	19.1	19.1	45.0	40.0	Total	4.5	394936	4946391	129.8
108	18.9	18.9	45.0	40.0	Total	4.5	394918	4946371	129.5
109	18.9	18.9	45.0	40.0	Total	4.5	394954	4946295	130.0
110	11.9	11.9	45.0	40.0	Total	4.5	397875	4945819	132.1
111	18.6	18.6	45.0	40.0	Total	4.5	394887	4946335	129.5
112	11.8	11.8	45.0	40.0	Total	4.5	397928	4945831	133.6
113	18.4	18.4	45.0	40.0	Total	4.5	394867	4946326	129.5
114	18.3	18.3	45.0	40.0	Total	4.5	394919	4946203	129.6
115	18.4	18.4	45.0	40.0	Total	4.5	395767	4945406	138.8
116	17.5	17.5	45.0	40.0	Total	4.5	394913	4946069	131.1
117	17.2	17.2	45.0	40.0	Total	4.5	394904	4946018	130.4
118	17.0	17.0	45.0	40.0	Total	4.5	394884	4945993	129.5
119	17.9	17.9	45.0	40.0	Total	4.5	395392	4945434	139.5
120	20.7	20.7	45.0	40.0	Total	4.5	395071	4945692	139.5
121	16.4	16.4	45.0	40.0	Total	4.5	394842	4945898	129.5
122	14.6	14.6	45.0	40.0	Total	4.5	394861	4945666	129.5
123	10.9	10.9	45.0	40.0	Total	4.5	394561	4945698	129.5



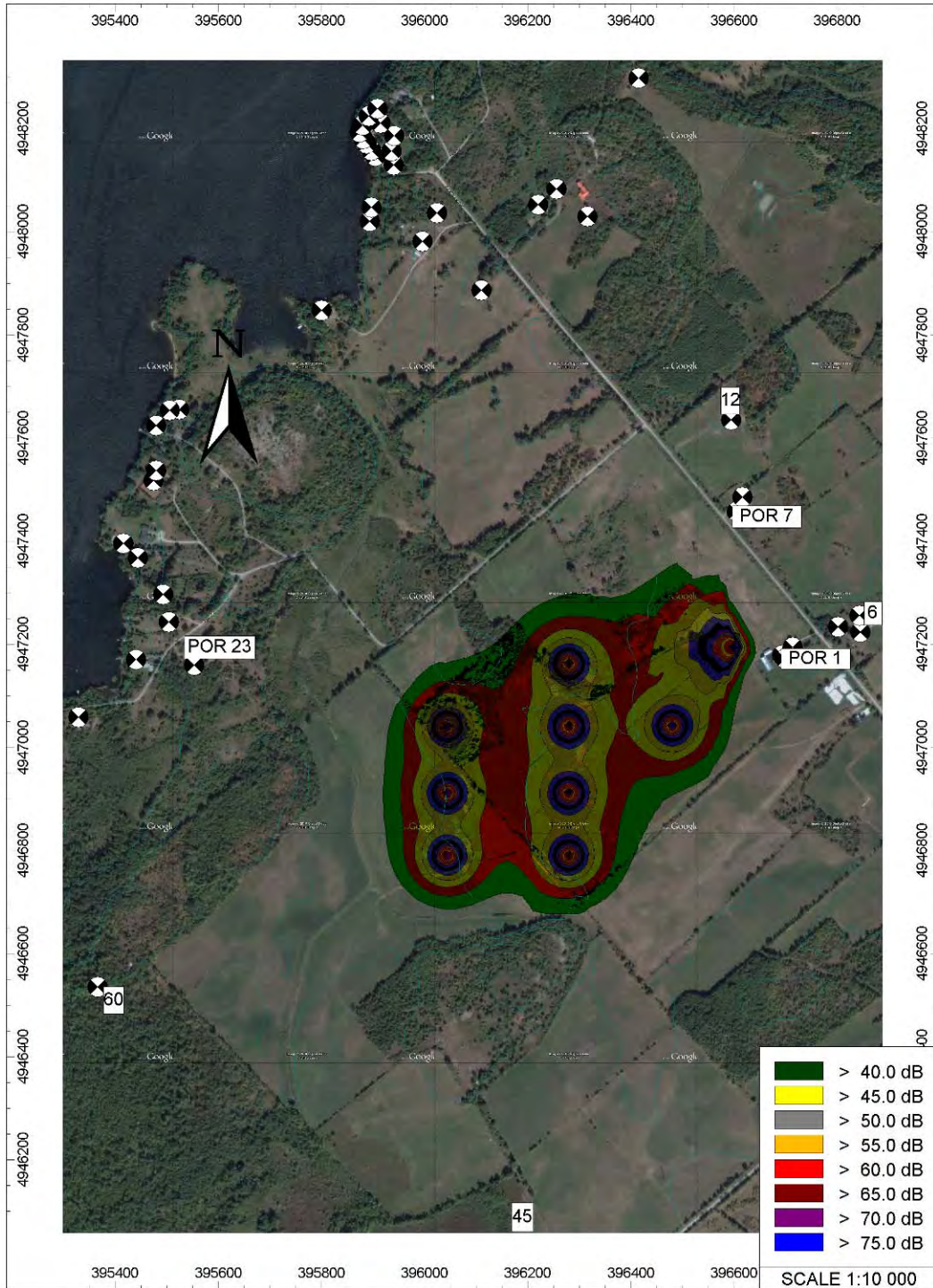

Figure C1 Noise Map