



**NORTHLAND
POWER**

Empire Solar Project

Noise Assessment Study Report

April 27, 2012

Northland Power Inc.
on behalf of
Northland Power Solar
Empire L.P.
Toronto, Ontario

Noise Assessment Study Report

Empire Solar Project

H334844-0000-07-124-0276

Rev. 0

April 27, 2012

Disclaimer

This report has been prepared by or on behalf of Northland Power Inc. for submission to the Ontario Ministry of the Environment as part of the Renewable Energy Approval process. The content of this report is not intended for the use of, nor is it intended to be relied upon by, any other person. Neither Northland Power Inc. nor any of its directors, officers, employees, agents or consultants has any liability whatsoever for any loss, damage or injury suffered by any third party arising out of, or in connection with, their use of this report.

Executive Summary

This report presents the results of the Noise Assessment Study required for Solar Facilities under Ontario Regulation 359/09 and 521/10, as part of the Renewable Energy Approval (REA) Process. Northland Power Solar Empire L.P. (“Northland”) is proposing to develop a 10-Megawatt (MW) solar photovoltaic (PV) project titled Empire Solar Project (the “Project”). The Project will be located on approximately 122 hectares (ha) of land within the Town of Cochrane.

This Noise Assessment Study Report has been prepared based on the document entitled “Basic Comprehensive Certificates of Approval (Air) – User Guide” by the Ontario Ministry of the Environment (MOE, 2004). The sound pressure levels at the points of reception (POR) have been estimated using ISO 9613-2, implemented in the CADNA-A computer code. The performance limits used for verification of compliance correspond to the values for rural areas of 40 dBA. The results presented in this report are based on the best available information at this time. It is the intention that, in the detailed engineering phase of the project, certified noise data based on final plans and designs will confirm the conclusions of this noise impact assessment study.

The results obtained in this study show that the sound pressure levels at POR will not exceed MOE requirements for rural areas of 40 dBA.

Project Report

April 27, 2012

**Northland Power Inc.
Empire Solar Project**

Noise Assessment Study Report

Table of Contents

**Report Disclaimer
Executive Summary**

1. Introduction 1

 1.1 Project Description 1

 1.2 Renewable Energy Approval Legislative Requirements 1

2. Facility Description 1

 2.1 Project Location 2

 2.2 Acoustical Environment 2

 2.3 Life of Project..... 2

 2.4 Operating Hours 2

 2.5 Approach to the Study..... 2

3. Noise Sources..... 3

 3.1 Substation Transformer..... 3

 3.2 Inverter Clusters 4

 3.3 Noise Summary Table..... 6

 3.4 Adjacent Solar Projects..... 7

4. Points of Reception 7

5. Mitigation Measures..... 8

6. Impact Assessment 9

 6.1 Compliance With Performance Limits 9

7. Conclusions and Recommendations 11

8. Signatures..... 12

9. References..... 13

Appendix A Land Use Zoning Designation Plan and Area Location Plan

Appendix B Noise Sources

Appendix C Points of Reception Coordinates and Noise Maps from CADNA-A

Appendix D CADNA-A Sample Calculations

List of Tables

Table 2.1	General Project Description	2
Table 3.1	Noise Source Summary	6
Table 4.1	Point of Reception Noise Impact from Individual Sources.....	8
Table 6.1	Performance Limits (One-Hour L_{eq}) by Time of Day for Class 3 Areas.....	9
Table 6.2	Calculated Sound Pressure Levels.....	10

List of Figures

Figure 2.1	CADNA-A Configurations.....	3
Figure 3.1	Schematic Inverter Cluster Layout	5
Figure 3.2	Inverter Cluster CADNA-A Acoustical Model	6

1. Introduction

1.1 Project Description

Northland Power Solar Empire L.P. (“Northland”) is proposing to develop a 10-megawatt (MW) solar photovoltaic (PV) project titled Empire Solar Project (the “Project”). The Project will be located on approximately 122 ha of land within the Town of Cochrane.

The proposed Project is a renewable energy generation facility which will use solar photovoltaic technology to generate electricity. Electricity generated by solar photovoltaic panels will be converted from Direct Current (DC) to Alternating Current (AC) by inverter clusters which will also step-up the voltage to 27.6 kV. A main transformer, located in the substation, will step up the voltage from the clusters to 115 kV prior to being transmitted to the existing local distribution line.

In order to meet the Ontario Power Authority (OPA)’s Feed-In-Tariff (FIT) Program requirements, a specific percentage of equipment will be manufactured in Ontario.

The construction of the Project will begin once the Renewable Energy Approval (REA) has been obtained and a power purchase agreement is finalized with the OPA. The anticipated operational lifespan of the Project is 30 years.

1.2 Renewable Energy Approval Legislative Requirements

Ontario Regulation 359/09 and 521/10, made under the Environmental Protection Act identify the Renewable Energy Approval (REA) requirements for green energy projects in Ontario. As per Section 4 of these regulations, ground mounted solar facilities with a name plate capacity greater than 12 kilowatts (kW) are classified as a Class 3 solar facility, and therefore, require an REA.

Section 13 of the Ontario Regulation 359/09 requires proponents of Class 3 solar facilities to complete a Noise Study Report in accordance with Appendix A of the publication; “Basic Comprehensive Certificates of Approval (Air) – User Guide, 2004” by the Ministry of the Environment (MOE, 2004).

The Noise Study Report is to include a general description of the facility, sources and points of reception (POR), Assessment of compliance, as well as all the supporting information relevant to the Project. A draft of the Noise Study Report must be made available to the public, the local municipality and identified Aboriginal communities, at least 60 days prior to the final public consultation meeting in accordance with Ontario Regulation 359/09 and 521/10.

2. Facility Description

The Project will utilize photovoltaic (PV) panels installed on fixed racking structures mounted on the ground. The PV panels generate DC electricity which will be converted to AC electricity by inverters. The Project layout is based on seven inverter clusters each one containing two inverters and one medium-voltage (27.6-kV/1.6-MVA) transformer, and one 115-kV/10-MVA substation transformer. The 27.6-kV power, collected from the inverter clusters, will be stepped up to 115 kV by the substation transformer prior to being transmitted to the existing local distribution line.

Since the panels will be ground-mounted and the total nameplate capacity is over 12 kW, the Project is considered to be a Class 3 Solar Facility according to the classification presented in Ontario Regulation 521/10.

Table 2.1 General Project Description

Project Description	Ground-mounted Solar PV, Class 3
System Nameplate Capacity	10 MW AC
Local Distribution Company	N/A

2.1 Project Location

The Project Location¹ will be on privately owned land, zoned as rural, totalling approximately 122 ha. Figure A.1 in Appendix A shows the zoning designation plan. Figure A.3 and Figure A.2 present the Project Area Location Plan, as well as the adjacent solar facilities proposed in the vicinity of the Project.

2.2 Acoustical Environment

The Project will be surrounded by forested areas to the east and north-east, and mainly farmland to the north-west, west and south. The background noise levels are expected to be typical of rural areas, classified as a Class 3 based on Publication NPC-232 by the MOE. Some traffic noise is expected from Glackmeyer Concession Road 6&7 on the southern boundary of the site and N road to the west. These sources should, however, only be of concern during day hours. The Cochrane Airport is located about 2.5 km southwest of the Project Location. The Town of Cochrane is situated approximately 7 km to the south and the Trans-Canada Highway passes through Cochrane at a minimum distance of 8 km from the Project Location.

2.3 Life of Project

The expected life of the Project is 30 years. The manufacturer's warranty on the PV modules is 25 years and the expected life of solar power plants of this type is typically 35 to 40 years. At that time (or earlier if the 20-yr power purchase agreement is not extended), the Project will be decommissioned or refurbished depending on market conditions and/or technological changes.

2.4 Operating Hours

Solar PV facilities produce electricity during the day hours, when the sun's rays are collected by the panels. After sunset the facility will not receive solar radiation to generate any electricity. Under these conditions the inverters will not produce any noise and the transformers will be energized, but not in operation (no fans in operation).

2.5 Approach to the Study

The sound pressure levels at the POR were predicted using procedures from ISO 9613-2, which is a widely used and generally accepted standard for the evaluation of noise impact in environmental assessments. The sound power level for the inverters was provided by the manufacturer while the sound power level for the transformers was estimated. The software package CADNA-A, which implements ISO-9613-2, was used to predict the noise levels at the POR. This numerical modeling software is able to simulate sound sources as well as sound mitigation measures taking into account atmospheric and ground attenuation. Some of the CADNA-A configurations used in the modeling are shown in Figure 2.1. The height contours for the site were taken from the Ontario Base Maps (OBM).

¹ "Project Location" in the context of this study is an area occupied by the Project infrastructure.

For modeling purposes, the vegetation that blocks some of the POR from the sources has not been incorporated.

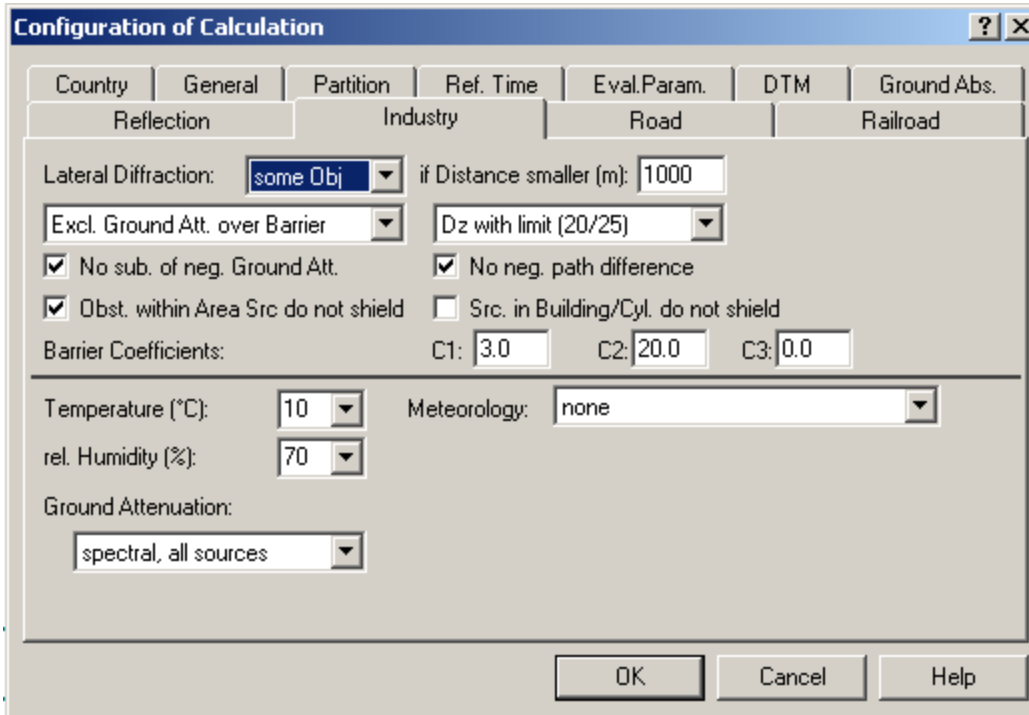

Figure 2.1 CADNA-A Configurations

3. Noise Sources

The main sources of noise from the Project will be seven inverter clusters, each one containing two inverters and one medium-voltage transformer, and a substation containing the main step-up transformer. The Project layout is provided in Figure A.3. The coordinates of each noise source are presented in Table B.1 of Appendix B. It should be noted that the 115-kV/10-MVA transformer will be located on the Martin’s Meadow Project Site and will be positioned in close proximity to the Martin Meadows and Abitibi Solar Project 115-kV/10-MVA transformers. Even though these sources are detailed in their respective project reports, all three projects (Martin Meadow, Abitibi and Empire) were modelled together to accurately determine the contribution from all noise sources.

All noise sources were modeled as non-directional point sources.

Switchgear and a small step-down transformer used for lighting, located at the substation, do not emit any significant noise and consequently have not been considered as sources of noise.

For the purpose of this study it is assumed that all inverters and transformers will be operating 24 hours at full capacity.

3.1 Substation Transformer

A 10-MVA step-up transformer that will step up the 27.6-kV power to 115 kV, required by the local distribution company, will be located in the substation. Since the transformer make and model has

not been selected at this point (although it is known that the transformer will be of ONAF (oil natural air forced) type), a conservative estimate of sound power level was based on the data from NEMA TRI – 1993 (2000) and 58.7-m² transformer surface area. This standard provides maximum sound level values for transformers, and manufacturers routinely meet this specification. Hence, the results based on NEMA may slightly overestimate the impact on POR since the actual transformer is expected to be quieter. The NEMA levels were then converted into frequency spectra using empirical correlations for transformer noise (Crocker, 2007). This calculation is available in Figure B.3 of Appendix B. The transformer configurations are expected to be similar to those shown in Figure B.2. Noise source height representing the transformer was assumed at 3.6 m above grade.

Power transformers are considered by the MOE to be tonal noise sources. A 5-dB penalty was added to the sound power spectrum, as recommended by Publication NPC-104, “Sound Level Adjustments” for tonality. Table B.3 in Appendix B shows the frequency spectrum used to model the substation transformer.

3.2 Inverter Clusters

Northland is planning to use inverters manufactured by SMA. Seven inverter clusters will be installed as part of the Project. Each cluster comprises of two SMA Sunny Central 800CP inverters and one medium voltage transformer. A schematic layout with approximate dimensions of such cluster is available in Figure 3.1, additional information regarding details of the inverter cluster can be found in Appendix B). The cluster components listed above were modeled as point sources shown in Figure 3.2. Note that the planned enclosure over the inverters was not taken into account as a mitigation measure in the noise model.

The installed capacity of each Sunny Central 800CP inverter is 800 kW. SMA provided third-octave noise data for the Sunny Central 800CP inverter (Figure B.1 of Appendix B). The provided third octave spectrum was converted to a full octave spectrum and the contribution from two inverters was combined into a single sound power spectrum for use with CADNA-A model (calculations are available in Figure B.4 of Appendix B). A 5-dBA penalty was added to the frequency spectrum, as stipulated in Publication NPC-104, “Sound Level Adjustments,” to allow for tonality. The frequency spectrum used to model combined noise emission from the two inverters located next to each other within the same cluster is shown in Table B.3 of Appendix B.

A 1.6-MVA transformer used to step-up the 360-V power from the inverters to 27.6 kV will be located in close proximity to the inverters. Since the transformer make and model have not been selected at this point (although it is known that the transformer will be of ONAN (oil natural air natural) type), the sound power levels resulting from the operation of the transformer were evaluated using data from NEMA TR 1-1993 (R2000) and 14.88-m² transformer surface area. The NEMA levels were then converted into frequency spectrum using empirical correlations for transformer noise (Crocker, 2007). This calculation is available in Figure B.5 of Appendix B. Power transformers are considered by the MOE to be tonal noise sources. A 5-dB penalty was added to the sound power spectrum, as recommended by Publication NPC-104, “Sound Level Adjustments” for tonality. Table B.3 in Appendix B shows the frequency spectrum used to model the transformers located in the clusters.

Although for the modeling purposes it was assumed that the facility will operate 24 h at full capacity, in reality at night the facility will be idle. Under these conditions the inverters do not produce noise.

The transformers (at the substation and clusters) are energized and make some magnetostrictive noise at a reduced level, but no cooling fans are in operation.

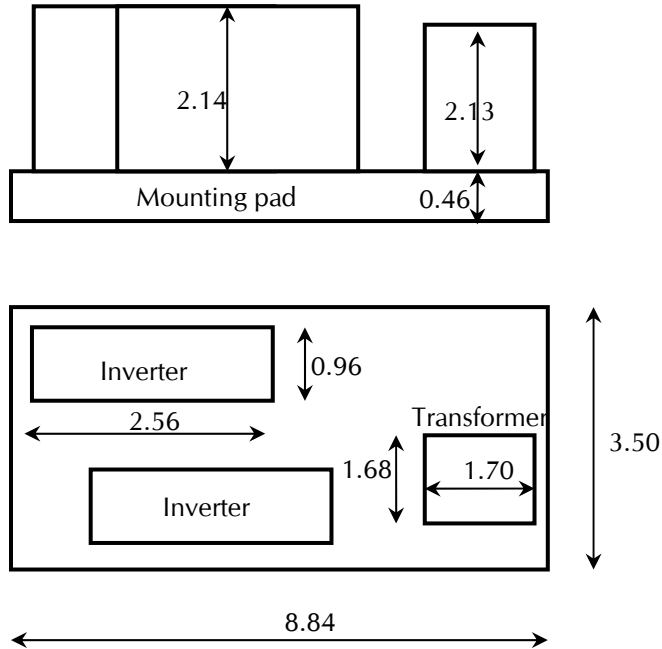

Figure 3.1 Schematic Inverter Cluster Layout
(all dimensions in metres)

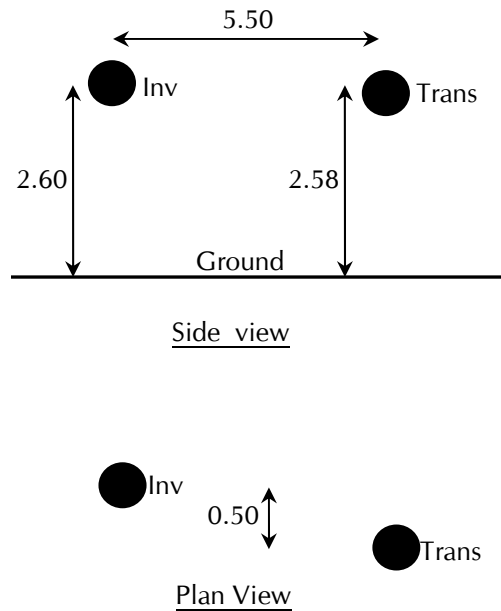

Figure 3.2 Inverter Cluster CADNA-A Acoustical Model

where: Inv = Noise Source Representing Two Sunny Central 800CP Inverters; and Trans = Noise Source Representing 27.6-kV/1.6-MVA Cluster Transformer (all dimensions in metres).

3.3 Noise Summary Table

A summary of the sound sources described above, including sound power level, characteristics and proposed noise control measures, is presented in Table 3.1.

Table 3.1 Noise Source Summary for Empire Solar Project

Source ID	Description	Total Sound Power Level (dBA)	Source Location	Sound Characteristics	Noise Control Measures
EM_Sub	115-kV/10-MVA substation transformer	95.1	O	S-T	U
EM_Inv1	Two Sunny Central 800CP inverters at Cluster 1	91.3	O	S-T	U
EM_Inv2	Two Sunny Central 800CP inverters at Cluster 2	91.3	O	S-T	U
EM_Inv3	Two Sunny Central 800CP inverters at Cluster 3	91.3	O	S-T	U
EM_Inv4	Two Sunny Central 800CP inverters at Cluster 4	91.3	O	S-T	U
EM_Inv5	Two Sunny Central 800CP inverters at Cluster 5	91.3	O	S-T	U
EM_Inv6	Two Sunny Central 800CP inverters at Cluster 6	91.3	O	S-T	U
EM_Inv7	Two Sunny Central 800CP inverters at Cluster 7	91.3	O	S-T	U

Source ID	Description	Total Sound Power Level (dBA)	Source Location	Sound Characteristics	Noise Control Measures
EM_Trans1	27.6-kV/1.6-MVA cluster transformer at Cluster 1	80.1	O	S-T	U
EM_Trans2	27.6-kV/1.6-MVA cluster transformer at Cluster 2	80.1	O	S-T	U
EM_Trans3	27.6-kV/1.6-MVA cluster transformer at Cluster 3	80.1	O	S-T	U
EM_Trans4	27.6-kV/1.6-MVA cluster transformer at Cluster 4	80.1	O	S-T	U
EM_Trans5	27.6-kV/1.6-MVA cluster transformer at Cluster 5	80.1	O	S-T	U
EM_Trans6	27.6-kV/1.6-MVA cluster transformer at Cluster 6	80.1	O	S-T	U
EM_Trans7	27.6-kV/1.6-MVA cluster transformer at Cluster 7	80.1	O	S-T	U

Notes:

1. A 5-dBA penalty is included in this table.
2. Location: Inside building (I), Outside building (O).
3. Sound Characteristics: Steady (S), Tonal (T), Impulsive (I), Quasi-Steady Impulsive (QSI).
4. Noise Control: Silencer (S), Acoustic lining (A), Barrier (B), Lagging (L), Enclosure (E), Other (O), Uncontrolled (U).

3.4 Adjacent Solar Projects

To identify the adjacent solar projects Hatch’s internal database of solar projects and MOE records available in http://www.ene.gov.on.ca/environment/en/subject/renewable_energy/projects/index.htm were searched. (January 03, 2011)

There are two solar projects, Martin’s Meadows and Abitibi, located in the proximity of the Empire Solar Project. Noise sources from these two projects were taken into account in the study. Both projects, owned by Northland with 10-MW capacity each, are identical to Empire Solar Project. Coordinates for the inverter clusters and substation transformers were provided by Northland. All noise sources from these two project were assumed unmitigated and their coordinates as well as sound power levels used for modeling are included in Appendix B.

4. Points of Reception

The POR used in this study were identified from the OBM and Google Earth Pro aerial imagery (August 2003) within 1-km distance from the Project Site² boundary and substation transformer, and also from visual observations of the Project Site surroundings conducted in Summer 2010.

The POR corresponding to the vacant lots were added based on parcel information provided by First Base Solutions (Teranet Data) and located according to the requirements outlined in Ontario Regulation 359/09, and its amendment (Ontario Regulation 521/10).

² “Project Site” in the context of this study is the complete area designated for the Project but not necessarily occupied with the project infrastructure. Project Location is always contained within Project Site.

The total number of POR within a 1-km distance from the Project Site of Empire Solar Project boundary and substation transformer located on the Martin’s Meadow Project Site is 57, including the vacant lots. Three of these noise receptors, identified in Table 4.1, were chosen as representative receptors for evaluating the noise contribution from each individual source. These three receptors were chosen in order to represent sound pressure level contributions on different areas around the Project Location. The complete set of results for all 57 noise receptors is provided in

Table 6.2, including contribution from each individual project.

For this study, the elevation above ground used for the POR is 4.5 m. Also, noise compliance was verified within 30-m distance from any given POR located at 1.5 m above the ground level.

A complete list of 68 POR located within 1 km from any of the three solar projects under consideration is provided in Table C.1 of Appendix C.

Table 4.1 Point of Reception Noise Impact from Individual Noise Sources of Empire Solar Project

Source ID	POR 14		POR 39		POR 47	
	Distance (m)	Leq Sound Level (dBA)	Distance (m)	Leq Sound Level (dBA)	Distance (m)	Leq Sound Level (dBA)
EM_Sub	1513	17.7	2108	13.7	2081	9.6
EM_Inv1	1136	16.7	288	30.1	393	23.3
EM_Inv2	1008	18.0	494	25.2	561	19.9
EM_Inv3	753	21.0	544	24.2	779	16.7
EM_Inv4	918	19.0	685	22.0	734	17.3
EM_Inv5	628	22.8	722	21.5	912	15.1
EM_Inv6	544	24.2	907	19.1	1064	13.5
EM_Inv7	863	19.6	878	15.5	916	15.1
EM_Trans1	1141	5.5	289	19.2	389	12.2
EM_Trans2	1013	6.9	494	14.2	557	8.7
EM_Trans3	758	9.9	541	13.3	775	5.5
EM_Trans4	924	7.9	685	11.0	732	6.0
EM_Trans5	633	11.8	720	10.5	908	3.8
EM_Trans6	549	13.2	905	8.1	1061	2.2
EM_Trans7	868	8.5	878	4.2	914	3.7

5. Mitigation Measures

The analysis indicates that no mitigation measures are necessary to meet the MOE requirement of 40 dBA for all POR.

6. Impact Assessment

The purpose of the acoustic Assessment report is to demonstrate that the facility is in compliance with the noise performance limits. The Project will be located in a Class 3 Area, based on the classification defined in Publication NPC-232 by the MOE. Class 3 area means a rural area with an acoustical environment that is dominated by natural sounds with little or no traffic noise.

Table 6.1 shows the performance limits set by the MOE for Class 3 Areas, according to Publication NPC-232.

Table 6.1 Performance Limits (One-Hour L_{eq}) by Time of Day for Class 3 Areas

Time of Day	One Hour L_{eq} (dBA) Class 3 Area
07:00 to 19:00	45.0
19:00 to 23:00	40.0
23:00 to 07:00	40.0

The solar facility will be operating during the daylight hours, that is, between 07:00 and 19:00 during most days of the year. However, in the summer months the sun may shine until past 19:00, or before 07:00. As such, during the summer the facility will be operating at the time when the applicable performance limit changes from 45 dBA to 40 dBA. Also, the transformers remain energized at night. In order to account for this the study assumes that the facility will be operating 24 hours and compares the impact from the facility with the 40-dBA limit. In reality, the cooling fans will not be in operation at night.

For this study, the overall ground attenuation coefficient was estimated to be 0.7. Appendix D includes a list of all the parameters used in the CADNA-A model to predict the sound pressure levels at the POR.

The modelling does not consider the effect of the solar panels on the predicted sound pressure levels at the points of reception. The solar panels may act as barriers to further reduce noise at the POR.

6.1 Compliance With Performance Limits

Table 6.2 presents the predicted sound pressure levels for the POR located within 1 km from the Project Site and 115-kV substation transformer. Sound pressure contours at 4.5 m and 1.5 m are available in Figure C.1 and Figure C.2. Appendix D includes a detailed calculation log of the representative POR with the highest Sound Pressure Level.

Effect of the noise emissions at the POR was also assessed by intersecting the 40-dBA sound pressure contours calculated at 1.5-m above ground with 30-m radius circles placed around the POR (Figure C.2). The results show that none of the 30-m radius zones are affected by the noise emissions.

Table 6.2 Calculated Sound Pressure Levels at POR within 1 km of Empire Solar Project

(Shaded rows correspond to representative POR)

Existing = Existing dwelling, Vacant = Vacant Lot.

The performance limit is 40.0-dBA. Empty cells represent projects where all sources are further than 3000-m from the POR.

POR ID	Description	Sound Pressure Contribution (dBA) from Projects				Performance Limit (dBA)	POR Height (m)	Min distance to the Project Source (m)	UTM Coordinates NAD 83 Zone 17 (m)		
		Abitibi	Empire	Martin's Meadow	Total				X	Y	Z
1	Existing	9.6	21.4	14.9	22.5	40.0	4.5	1423	499024	5441175	274.5
2	Existing	15.9	20.7	18.8	23.6	40.0	4.5	1633	499038	5443184	270.4
3	Existing	11.2	23.2	16.2	24.2	40.0	4.5	1186	499229	5441298	274.5
4	Existing	11.4	23.3	16.4	24.4	40.0	4.5	1167	499237	5441326	274.5
5	Existing	11.2	23.2	16.2	24.2	40.0	4.5	1185	499243	5441270	274.5
6	Existing	10.9	22.9	15.8	23.9	40.0	4.5	1212	499256	5441185	274.5
7	Existing	10.7	22.8	15.6	23.8	40.0	4.5	1232	499266	5441129	274.5
8	Existing	10.9	23.0	15.8	24.0	40.0	4.5	1207	499268	5441174	274.5
9	Vacant	12.6	25.3	17.0	26.1	40.0	4.5	941	499626	5441135	274.5
10	Vacant	14.6	27.1	18.1	27.8	40.0	4.5	756	499742	5441281	274.5
11	Existing	12.8	25.9	17.3	26.6	40.0	4.5	882	499772	5441081	274.5
12	Existing	21.6	26.3	24.3	29.3	40.0	4.5	922	499779	5442916	274.5
13	Existing	13.9	26.6	17.7	27.3	40.0	4.5	809	499788	5441162	274.5
14	Existing	19.9	30.0	23.2	31.1	40.0	4.5	544	499793	5442322	274.5
15	Existing	20.2	29.5	23.5	30.8	40.0	4.5	573	499793	5442405	274.5
16	Vacant	15.5	28.2	18.6	28.8	40.0	4.5	666	499853	5441296	274.5
17	Existing	22.7	25.9	25.2	29.5	40.0	4.5	1054	499854	5443135	274.5
18	Existing	22.8	25.7	25.4	29.6	40.0	4.5	1045	499855	5443171	274.5
19	Existing	21.0	29.2	24.6	30.9	40.0	4.5	593	499872	5442560	274.5
20	Existing	21.0	29.2	24.6	30.9	40.0	4.5	593	499872	5442560	274.5
21	Vacant	15.3	28.0	18.4	28.6	40.0	4.5	688	499886	5441238	274.5
22	Vacant		20.5	10.1	20.9	40.0	4.5	1495	499888	5440275	272.9
24	Vacant	14.5	27.2	17.9	27.9	40.0	4.5	762	499893	5441142	274.5
26	Existing	22.4	27.2	25.3	30.2	40.0	4.5	830	499897	5442883	274.5
27	Existing	22.4	27.2	25.3	30.2	40.0	4.5	830	499897	5442883	274.5
28	Existing	22.2	27.7	25.2	30.3	40.0	4.5	766	499898	5442807	274.5
29	Existing	22.2	27.7	25.2	30.3	40.0	4.5	766	499898	5442807	274.5
30	Existing	23.9	24.8	25.6	29.6	40.0	4.5	939	500011	5443727	272.8
31	Existing	24.2	25.1	25.9	29.9	40.0	4.5	909	500036	5443710	272.6
32	Existing	24.3	25.2	26.0	30.0	40.0	4.5	898	500040	5443691	272.7
33	Existing	29.7	29.6	31.0	34.9	40.0	4.5	502	500519	5443722	268.9
34	Existing	17.5	32.3	20.2	32.6	40.0	4.5	350	500520	5441238	271.7
35	Existing	16.6	31.1	19.0	31.5	40.0	4.5	413	500523	5441170	270.8
36	Existing	30.4	30.5	31.7	35.7	40.0	4.5	459	500531	5443672	269.1
37	Existing	18.9	33.1	20.5	33.5	40.0	4.5	308	500532	5441278	272.6

POR ID	Description	Sound Pressure Contribution (dBA) from Projects				Performance Limit (dBA)	POR Height (m)	Min distance to the Project Source (m)	UTM Coordinates NAD 83 Zone 17 (m)		
		Abitibi	Empire	Martin's Meadow	Total				X	Y	Z
38	Existing	18.4	32.8	20.3	33.1	40.0	4.5	323	500536	5441261	272.4
39	Existing	19.0	33.5	21.0	33.9	40.0	4.5	288	500557	5441291	273.2
40	Vacant	32.2	32.6	33.4	37.5	40.0	4.5	368	500561	5443555	270.5
41	Existing	19.0	33.2	21.5	33.7	40.0	4.5	293	500591	5441277	273.7
42	Existing	18.9	32.8	20.9	33.2	40.0	4.5	313	500594	5441257	273.4
43	Vacant	31.7	31.7	32.9	36.9	40.0	4.5	398	500664	5443707	268.4
44	Existing	28.6	27.9	29.9	33.6	40.0	4.5	599	500733	5443954	265.8
45	Existing	18.5	29.3	20.4	30.1	40.0	4.5	456	500884	5441176	269.6
46	Existing	34.2	33.7	35.6	39.3	40.0	4.5	316	500922	5443686	268.1
47	Existing	19.3	27.4	21.6	28.9	40.0	4.5	389	500924	5441293	267.5
48	Existing	19.0	26.2	21.2	28.0	40.0	4.5	457	500960	5441232	265.6
49	Existing	19.4	26.9	21.7	28.6	40.0	4.5	423	500971	5441294	264.5
50	Existing	33.4	32.4	36.6	39.3	40.0	4.5	366	501068	5443688	266.8
51	Existing	29.9	28.0	32.7	35.4	40.0	4.5	588	501204	5443865	264.5
52	Existing	30.0	27.7	32.9	35.5	40.0	4.5	612	501290	5443829	264.5
53	Existing	31.2	28.3	34.9	37.0	40.0	4.5	579	501374	5443676	264.5
54	Vacant	17.1	23.8	20.8	26.1	40.0	4.5	1006	501542	5441106	266.4
55	Vacant	18.1	24.8	21.7	27.1	40.0	4.5	1005	501607	5441267	270.3
56	Vacant	31.4	24.6	30.1	34.3	40.0	4.5	871	501690	5443693	264.5
57	Vacant	31.4	24.6	30.1	34.3	40.0	4.5	871	501690	5443693	264.5
58	Existing	32.7	24.3	29.9	34.9	40.0	4.5	908	501758	5443607	264.5
61	Existing	32.3	23.6	28.9	34.3	40.0	4.5	973	501803	5443683	264.5

The results of this study show that all POR are compliant with MOE guidelines based on the performance limit of 40-dBA.

7. Conclusions and Recommendations

For the Empire Solar Project, the sound pressure levels at the POR have been estimated using the CADNA-A model, based on ISO 9613-2. It has been determined that no mitigation measures are needed for the Project operation in accordance with Ontario Regulation 359/09 and 521/10.

Based on the results obtained in this study, it is concluded that the sound pressure levels at the POR will be below MOE requirements for Class 3 areas of 40 dBA at all times.

8. Signatures

Report Prepared By

Auret Basson, Mechanical Engineering Intern

Report Reviewed and Approved By

Oleg Belashov, M.A.Sc., P.Eng.

9. References

Ontario Regulation 359/09. Environmental Protection Act. Renewable Energy Approvals Under Part V.0.1 of the Act.

Ontario Regulation 521/10 made under Environmental Protection Act amending O.Reg. 359/09.

Ministry of the Environment (MOE). 2004. Basic Comprehensive Certificates of Approval (Air) – User Guide (Appendix A). Environmental Assessment and Approvals Branch.

Handbook of Noise and Vibration Control; Malcolm J. Crocker, 2007;

IEEE. 2006. C57.12.90-2006: Standard Test Code for Liquid-Immersed, Power and Regulating Transformers. pp 64 to 76.

Ministry of the Environment (MOE). 1997. Noise Assessment Criteria in Land Use Planning. Publication LU-131. Ontario Ministry of the Environment. 12 pp + Annex.

MOE. 1995. Sound Level Limits for Stationary Sources in Class 1 & 2 Areas (Urban). Publication NPC-205. Ontario Ministry of the Environment. 6 pp + Annex.

MOE. 1995. Sound Level Limits for Stationary Sources in Class 3 Areas (Rural). Publication NPC-232. Ontario Ministry of the Environment. 8 pp + Annex.

NEMA. 2000. Standards Publication No. TR 1-1993 (R2000): Transformers, Regulators and Reactors. National Electrical Manufacturers Association. 31 pp. (This reference probably not needed now).

International Organization for Standardization (ISO). Standard 1996-1: Description, Measurement and Assessment of Environmental Noise – Part 1: Basic Quantities and Assessment Procedures.

International Organization for Standardization (ISO). Standard 1913-2: Acoustics – Attenuation of sound during propagation outdoors – Part 2: General Method of Calculation.

Appendix A

**Land Use Zoning Designation Plan and
Area Location Plans**

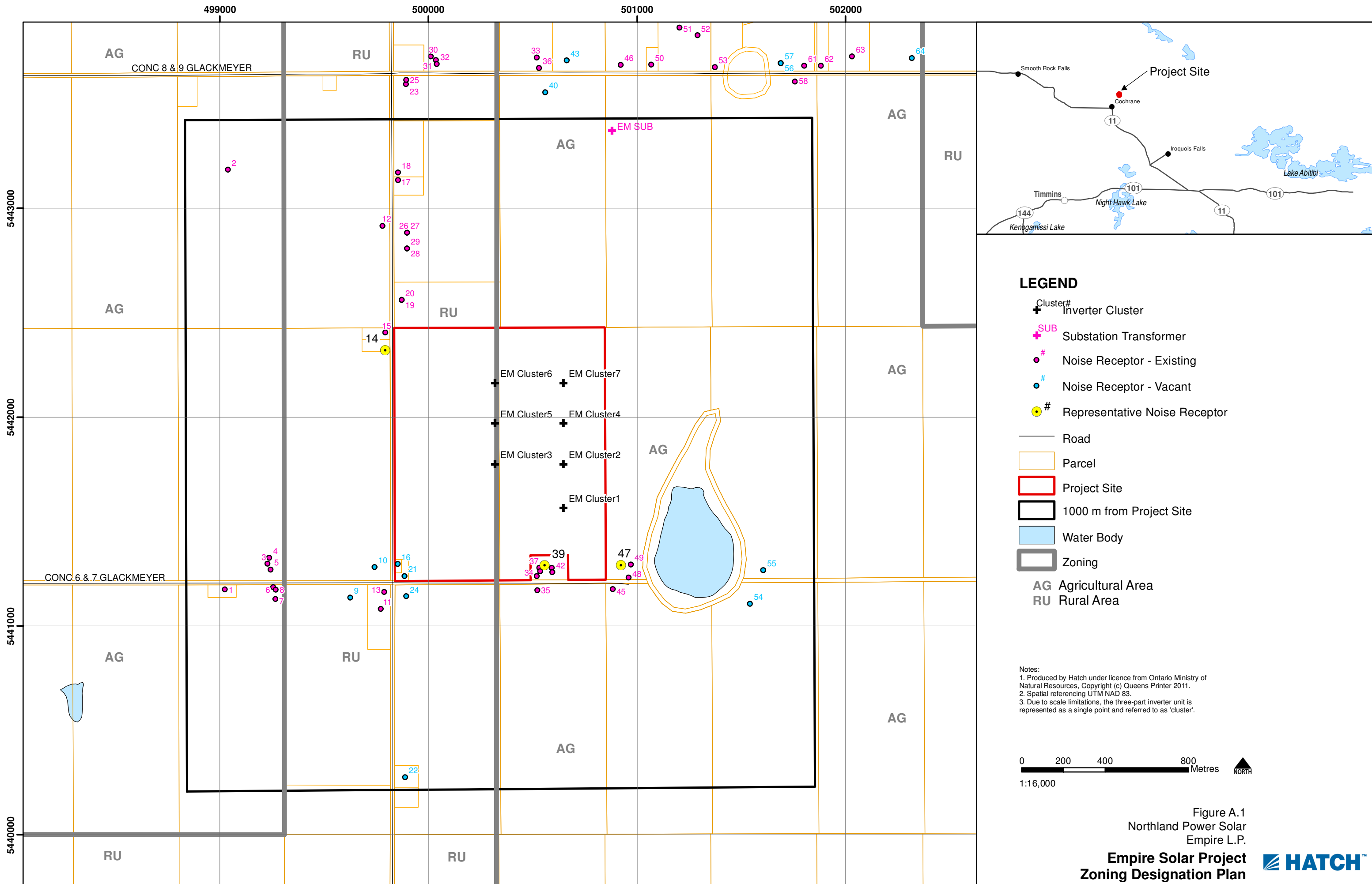

LEGEND

- Cluster#
+ Inverter Cluster
- SUB
+ Substation Transformer
- # Noise Receptor - Existing
- # Noise Receptor - Vacant
- # Representative Noise Receptor
- Road
- Parcel
- Project Site
- 1000 m from Project Site
- Water Body
- Zoning
- AG Agricultural Area
- RU Rural Area

Notes:
 1. Produced by Hatch under licence from Ontario Ministry of Natural Resources, Copyright (c) Queens Printer 2011.
 2. Spatial referencing UTM NAD 83.
 3. Due to scale limitations, the three-part inverter unit is represented as a single point and referred to as 'cluster'.



Figure A.1
 Northland Power Solar
 Empire L.P.
Empire Solar Project
Zoning Designation Plan



497000 498000 499000 500000 501000 502000 503000

5444000

5443000

5442000

5441000

5440000

5439000

CONC 8 & 9 GLACKMEYER

CONC 6 & 7 GLACKMEYER

CONC 4 & 5 GLACKMEYER

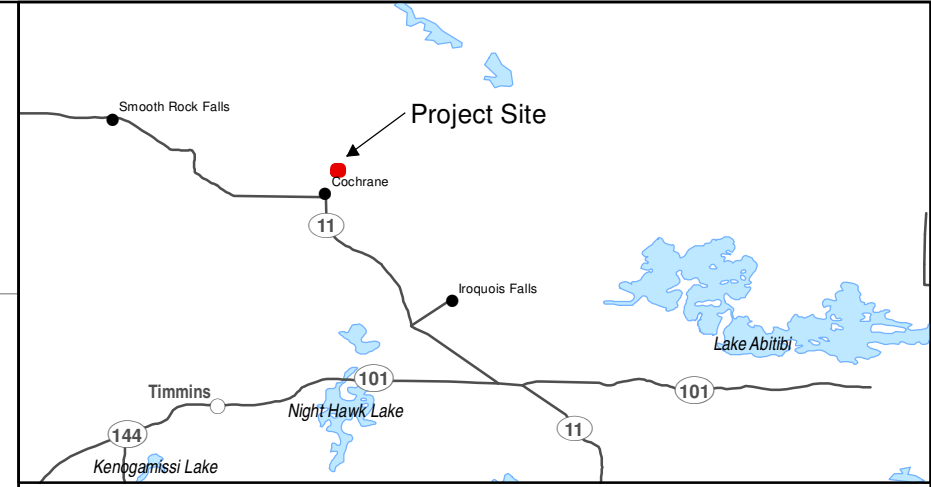

LEGEND

- Road
- Empire Project Site
- Abitibi Project Site
- Martin's Meadows Project Site
- 1000 m from Project Site
- Water Body

Notes:
 1. Produced by Hatch under licence from Ontario Ministry of Natural Resources, Copyright (c) Queens Printer 2011.
 2. Spatial referencing UTM NAD 83.



Figure A.2
 Northland Power Solar
 Empire L.P.
Empire Solar Project
Scaled Area Location Plan
- Adjacent Projects



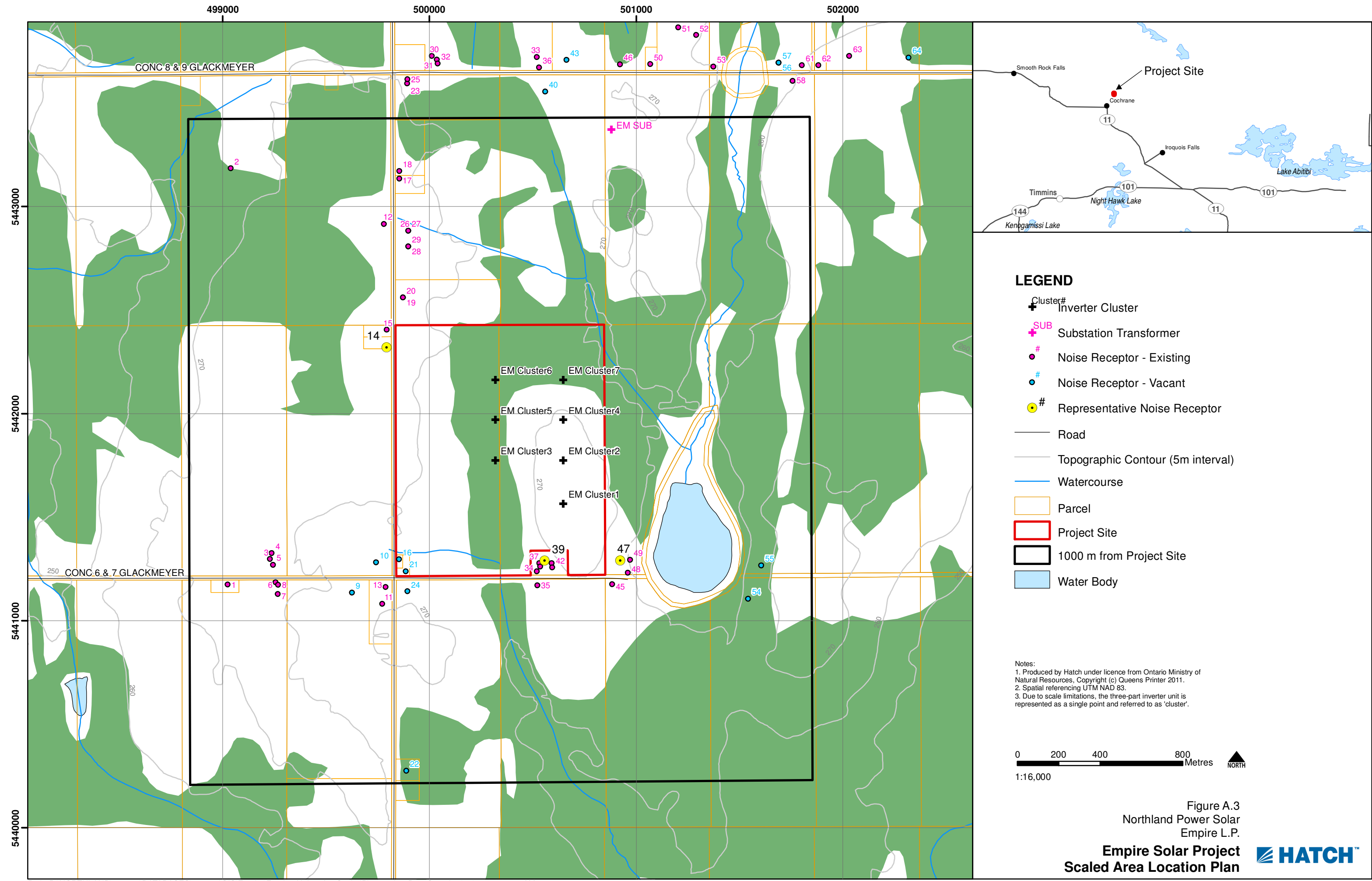

LEGEND

- Cluster# Inverter Cluster
- SUB Substation Transformer
- # Noise Receptor - Existing
- # Noise Receptor - Vacant
- # Representative Noise Receptor
- Road
- Topographic Contour (5m interval)
- Watercourse
- Parcel
- Project Site
- 1000 m from Project Site
- Water Body

Notes:
 1. Produced by Hatch under licence from Ontario Ministry of Natural Resources, Copyright (c) Queens Printer 2011.
 2. Spatial referencing UTM NAD 83.
 3. Due to scale limitations, the three-part inverter unit is represented as a single point and referred to as 'cluster'.



Figure A.3
 Northland Power Solar
 Empire L.P.
Empire Solar Project
Scaled Area Location Plan



Appendix B

Noise Sources

Table B.1 Point Sources from Empire Solar Project Used in CADNA-A, Includes Tonality Penalty of 5.0-dBA.

Source ID	Description	Spectra ID	Total sound power level (dBA)	Correction (dBA)	Height (m)	Coordinates, UTM NAD 83 Zone 17 (m)		
						X	Y	Z
EM_Sub	115-kV/10-MVA substation transformer	T115kV_10MVA	95.1	5.0	3.60	500880	5443373	271.2
EM_Inv1	Two Sunny Central 800CP inverters at Cluster 1	SMA_SC800CPX2	91.3	5.0	2.60	500641	5441566	272.6
EM_Inv2	Two Sunny Central 800CP inverters at Cluster 2	SMA_SC800CPX2	91.3	5.0	2.60	500641	5441777	272.6
EM_Inv3	Two Sunny Central 800CP inverters at Cluster 3	SMA_SC800CPX2	91.3	5.0	2.60	500313	5441777	272.6
EM_Inv4	Two Sunny Central 800CP inverters at Cluster 4	SMA_SC800CPX2	91.3	5.0	2.60	500641	5441970	272.6
EM_Inv5	Two Sunny Central 800CP inverters at Cluster 5	SMA_SC800CPX2	91.3	5.0	2.60	500313	5441970	272.6
EM_Inv6	Two Sunny Central 800CP inverters at Cluster 6	SMA_SC800CPX2	91.3	5.0	2.60	500313	5442164	272.6
EM_Inv7	Two Sunny Central 800CP inverters at Cluster 7	SMA_SC800CPX2	91.3	5.0	2.60	500641	5442164	268.6
EM_Trans1	27.6-kV/1.6-MVA cluster transformer at Cluster 1	T27.6kV_1.6MVA	80.1	5.0	2.58	500647	5441565	272.6
EM_Trans2	27.6-kV/1.6-MVA cluster transformer at Cluster 2	T27.6kV_1.6MVA	80.1	5.0	2.58	500647	5441776	272.6
EM_Trans3	27.6-kV/1.6-MVA cluster transformer at Cluster 3	T27.6kV_1.6MVA	80.1	5.0	2.58	500319	5441776	272.6
EM_Trans4	27.6-kV/1.6-MVA cluster transformer at Cluster 4	T27.6kV_1.6MVA	80.1	5.0	2.58	500647	5441970	272.6
EM_Trans5	27.6-kV/1.6-MVA cluster transformer at Cluster 5	T27.6kV_1.6MVA	80.1	5.0	2.58	500319	5441970	272.6
EM_Trans6	27.6-kV/1.6-MVA cluster transformer at Cluster 6	T27.6kV_1.6MVA	80.1	5.0	2.58	500319	5442164	272.6
EM_Trans7	27.6-kV/1.6-MVA cluster transformer at Cluster 7	T27.6kV_1.6MVA	80.1	5.0	2.58	500647	5442164	268.5

Table B.2 Point Sources from Abitibi and Martin's Meadows Solar Projects Used in CADNA-A, Includes Tonality Penalty of 5.0-dBA.

Source ID	Spectra ID	Total sound power level (dBA)	Correction (dB)	Height (m)	Coordinates, UTM NAD 83 Zone 17 (m)		
					X	Y	Z
AB_Sub	T115kV_10MVA	95.1	5.0	3.60	500903	5443373	271.2
AB_Inv1	SMA_SC800CPX2	91.3	5.0	2.60	502168	5443519	265.8
AB_Inv2	SMA_SC800CPX2	91.3	5.0	2.60	502249	5443317	267.7
AB_Inv3	SMA_SC800CPX2	91.3	5.0	2.60	502249	5443062	268.1
AB_Inv4	SMA_SC800CPX2	91.3	5.0	2.60	502249	5442806	266.4
AB_Inv5	SMA_SC800CPX2	91.3	5.0	2.60	501796	5442720	263.0
AB_Inv6	SMA_SC800CPX2	91.3	5.0	2.60	501796	5442922	263.8
AB_Inv7	SMA_SC800CPX2	91.3	5.0	2.60	501796	5443134	264.1
AB_Trans1	T27.6kV_1.6MVA	80.1	5.0	2.58	502163	5443520	265.7
AB_Trans2	T27.6kV_1.6MVA	80.1	5.0	2.58	502243	5443317	267.6
AB_Trans3	T27.6kV_1.6MVA	80.1	5.0	2.58	502243	5443062	268.0
AB_Trans4	T27.6kV_1.6MVA	80.1	5.0	2.58	502243	5442807	266.4
AB_Trans5	T27.6kV_1.6MVA	80.1	5.0	2.58	501802	5442720	263.0
AB_Trans6	T27.6kV_1.6MVA	80.1	5.0	2.58	501802	5442922	263.8
AB_Trans7	T27.6kV_1.6MVA	80.1	5.0	2.58	501802	5443133	264.1
MM_Sub	T115kV_10MVA	95.1	5.0	3.60	500892	5443362	271.3
MM_Inv1	SMA_SC800CPX2	91.3	5.0	2.60	501198	5443526	264.7
MM_Inv2	SMA_SC800CPX2	91.3	5.0	2.60	501247	5443117	262.7
MM_Inv3	SMA_SC800CPX2	91.3	5.0	2.60	501247	5442849	264.4
MM_Inv4	SMA_SC800CPX2	91.3	5.0	2.60	501247	5442593	264.4
MM_Inv5	SMA_SC800CPX2	91.3	5.0	2.60	500997	5442594	268.3
MM_Inv6	SMA_SC800CPX2	91.3	5.0	2.60	500997	5442850	272.2
MM_Inv7	SMA_SC800CPX2	91.3	5.0	2.60	501008	5443118	272.6
MM_Trans1	T27.6kV_1.6MVA	80.1	5.0	2.58	501197	5443521	264.7
MM_Trans2	T27.6kV_1.6MVA	80.1	5.0	2.58	501242	5443117	262.9
MM_Trans3	T27.6kV_1.6MVA	80.1	5.0	2.58	501242	5442849	264.6
MM_Trans4	T27.6kV_1.6MVA	80.1	5.0	2.58	501242	5442594	264.5
MM_Trans5	T27.6kV_1.6MVA	80.1	5.0	2.58	501002	5442594	268.3
MM_Trans6	T27.6kV_1.6MVA	80.1	5.0	2.58	501002	5442849	272.0
MM_Trans7	T27.6kV_1.6MVA	80.1	5.0	2.58	501002	5443118	272.6

Table B.3 Frequency Spectra Used for Modelling the Noise Sources, Not Including Tonality Penalty.

Spectra ID	Octave Spectrum (dBA)										
	31.5	63	125	250	500	1000	2000	4000	8000	A	lin
SMA_SC800CPX2		63.1	73.9	80.5	82.3	78.7	74.1	65.0	72.7	86.3	95.0
T27.6kV_1.6MVA	32.3	51.5	63.6	66.1	71.5	68.7	64.9	59.7	50.6	75.1	83.7
T115kV_10MVA	47.3	66.5	78.6	81.1	86.5	83.7	79.9	74.7	65.6	90.1	98.7

SUNNY CENTRAL 720CP / 760CP / 800CP

SC 720CP-10 / SC 760CP-10 / SC 800CP-10



Economic

- Direct deployment in the field due to outdoor enclosure
- Simplified shipping without concrete substation

Efficient

- Full nominal power at ambient temperatures up to 50 °C
- 10 % additional power for constant operation at ambient temperatures up to 25 °C

Flexible

- Powerful grid management functions (including LVRT)
- DC voltage range configurable

Reliable

- Easy and safe installation due to a separate connection area
- Optional: extended input voltage range up to 1,100 V

SUNNY CENTRAL 720CP / 760CP / 800CP

High performance as standard

The completely new design of the Sunny Central CP series saves you real money. The compact and weatherproof enclosure is easy to load and transport and can be installed almost anywhere – there is no need for heavy protective concrete substations any longer. The innovative cooling concept OptiCool allows it to operate at full nominal power with ambient temperatures up to 50 °C. With the powerful grid management functions you are perfectly prepared for today's utility requirements as well as those still to come. The intelligent power management is the most important feature: in continuous operation, the Sunny Central 800CP can feed 880 kVA to the grid at ambient temperatures of up to 25 °C – that's 10 % more than the rated nominal power.

Technical data	Sunny Central 720CP	Sunny Central 760CP	Sunny Central 800CP
Input Data			
MPP voltage range	515 V – 820 V ^{3) 5)}	545 V – 820 V ^{3) 5)}	570 V – 820 V ^{3) 5)}
Max. DC voltage	1000 V / 1100 V ¹⁾ Optional		
Max. DC current	1400 A	1400 A	1400 A
Number of DC inputs	9 fused inputs		
Output Values			
Nominal AC output @ 50 °C	720 kVA	760 kVA	800 kVA
Continuous AC power @ 25 °C	792 kVA	836 kVA	880 kVA
Max. AC current	1411 A	1411 A	1411 A
Nominal AC-current	1283 A	1283 A	1283 A
Nominal AC-voltage ±10 %	324 V	342 V	360 V
AC grid frequency 50 Hz	●	●	●
AC grid frequency 60 Hz	●	●	●
Power factor (cos φ)	0.9 leading ... 0.9 lagging		
Max. THD	< 3 %	< 3 %	< 3 %
Power consumption			
Internal consumption in operation	< 1500 W ⁴⁾	< 1500 W ⁴⁾	< 1500 W ⁴⁾
Standby consumption	< 100 W	< 100 W	< 100 W
External auxiliary voltage	3 x 230 V, 50 / 60 Hz	3 x 230 V, 50 / 60 Hz	3 x 230 V, 50 / 60 Hz
Dimensions and Weight			
Dimensions (W / H / D) in mm	2562 / 2279 / 956	2562 / 2279 / 956	2562 / 2279 / 956
Weight	1800 kg	1800 kg	1800 kg
Efficiency ²⁾			
Max. efficiency	98.6 %	98.6 %	98.6 %
Euro ETA	98.4 %	98.4 %	98.4 %
CEC-eta	98.4 %	98.4 %	98.4 %
Protection Rating and Ambient Conditions			
Protection rating (as per IEC 60529)	IP54	IP54	IP54
Protection rating (as per IEC 60721-3-3)	<ul style="list-style-type: none"> • Classification of chemically active substances: 3C2 • Classification of mechanically active substances: 3S2 		
Ambient conditions: fixed location, with protection against wind and weather			
Operation temperature range	-20 °C ... +50 °C	-20 °C ... +50 °C	-20 °C ... +50 °C
Rel. humidity	15 % ... 95 %	15 % ... 95 %	15 % ... 95 %
Fresh air consumption	3000 m ³ /h	3000 m ³ /h	3000 m ³ /h
Max. altitude above sea level	2000 m	2000 m	2000 m

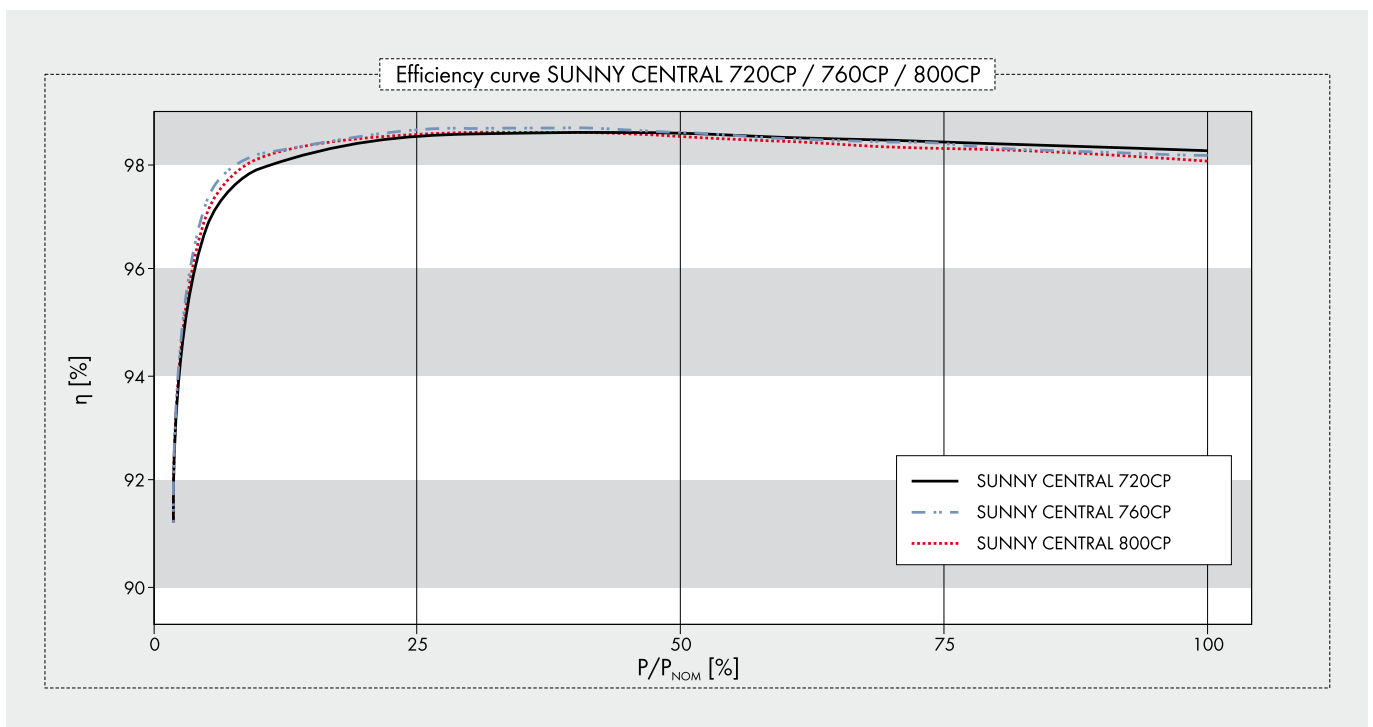

	Sunny Central 720CP	Sunny Central 760CP	Sunny Central 800CP
Features			
Sunny WebBox	●	●	●
Communication	Ethernet (optical fiber optional)	Ethernet (optical fiber optional)	Ethernet (optical fiber optional)
Communication with Sunny String-Monitor	RS485	RS485	RS485
LCD graphic display	●	●	●
Enclosure color	RAL 9016	RAL 9016	RAL 9016
Color of base	RAL 7005	RAL 7005	RAL 7005
Color of roof	RAL 7004	RAL 7004	RAL 7004
Ground fault monitoring / insulation monitoring	●	●	●
Circuit breaker AC side	●	●	●
Motor driven load disconnection switch on DC side	●	●	●
AC overvoltage protector	●	●	●
DC overvoltage protector	●	●	●
Overvoltage protectors for auxiliary supply	●	●	●
Certificates / Listings			
EMC		EN 61000-6-2 EN 61000-6-4	
CE conformity	●	●	●
BDEW-MSRL / FGW / TR8 ⁶⁾	●	●	●
RD 1633 / 2000	●	●	●
Arrêté du 23 / 04 / 08	●	●	●
● Standard features ○ Optional features – Not available			
Type name	SC 720CP-10	SC 760CP-10	SC 800CP-10

- 1) Startup at DC voltage < 1000 V
- 2) Efficiency measured without internal power supply
- 3) Further AC voltages, DC voltages and power classes can be configured (For detailed information see Technical Information „Innovations_CP“ at www.SMA.de)
- 4) Internal consumption at nominal power
- 5) At $1.05 U_{AC,nom}$ and $\cos \varphi = 1$
- 6) With complete dynamic grid support

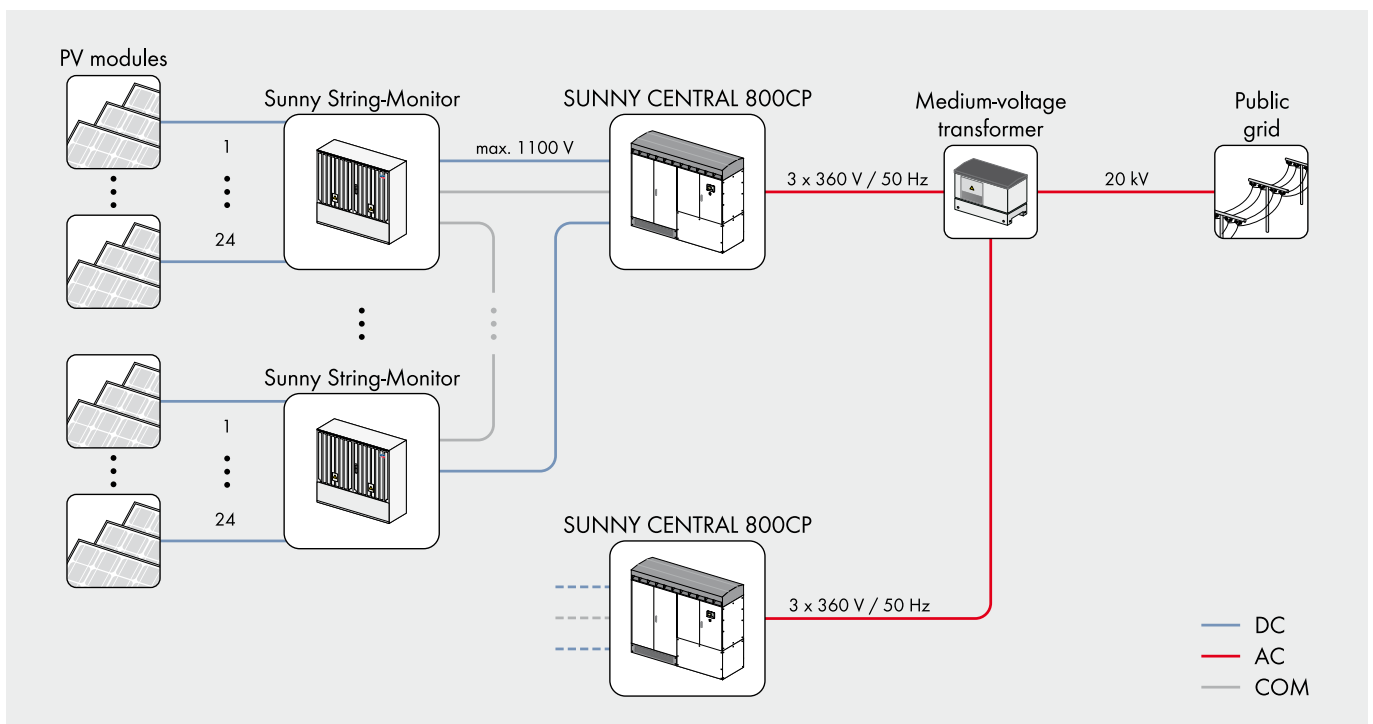

POWERFUL GRID MANAGEMENT FUNCTIONS

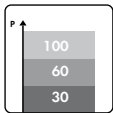

Remote controlled power reduction in case of grid overload

In order to avoid short-term grid overload, the grid operator presets a nominal active power value which the inverter will implement within 60 seconds. The nominal value is transmitted to the inverters via a ripple control receiver in combination with the SMA Power Reducer Box. Typical limit values are 100, 60, 30 or 0 per cent of the nominal power.

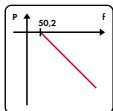

Frequency-dependent control of active power

As a grid frequency of 50.2 Hz, the inverter automatically reduces the fed-in of active power according to a definable characteristic curve which thereby contributes to the stabilization of the grid frequency.

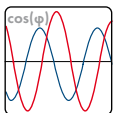

Static voltage support based on reactive power

To stabilize the grid voltage, SMA inverters feed reactive power (leading or lagging) into the grid. Three different modes are available:

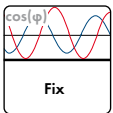

a) Fixed definition of the reactive power by the grid operator

The grid operator defines a fixed reactive power value or a fixed displacement factor between $\cos(\varphi)_{\text{leading}} = 0.90$ and $\cos(\varphi)_{\text{lagging}} = 0.90$.

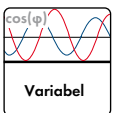

b) Definition of a dynamic setpoint of the reactive power by the utility operator

The grid operator defines a dynamic displacement factor - any value between $\cos(\varphi)_{\text{leading}} = 0.90$ und $\cos(\varphi)_{\text{lagging}} = 0.90$. It is transmitted either through a communication unit the evaluation can e.g. be evaluated and processed by the SMA Power Reducer Box.

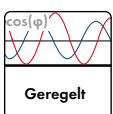

c) Control of the reactive power over a characteristic curve

The reactive power or the phase shift is controlled by a pre-defined characteristic curve - depending on the active power fed into the grid or the grid voltage.

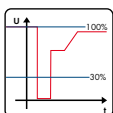

Limited Dynamic Grid Support

The inverter continues to feed to the grid after short term voltage drops - as long as the grid voltage is within a defined voltage window.

Dynamic Grid Support

LVRT (Low-Voltage Ride Through): The inverter stays connected to the grid during voltage drops and supports the grid by feeding reactive power.

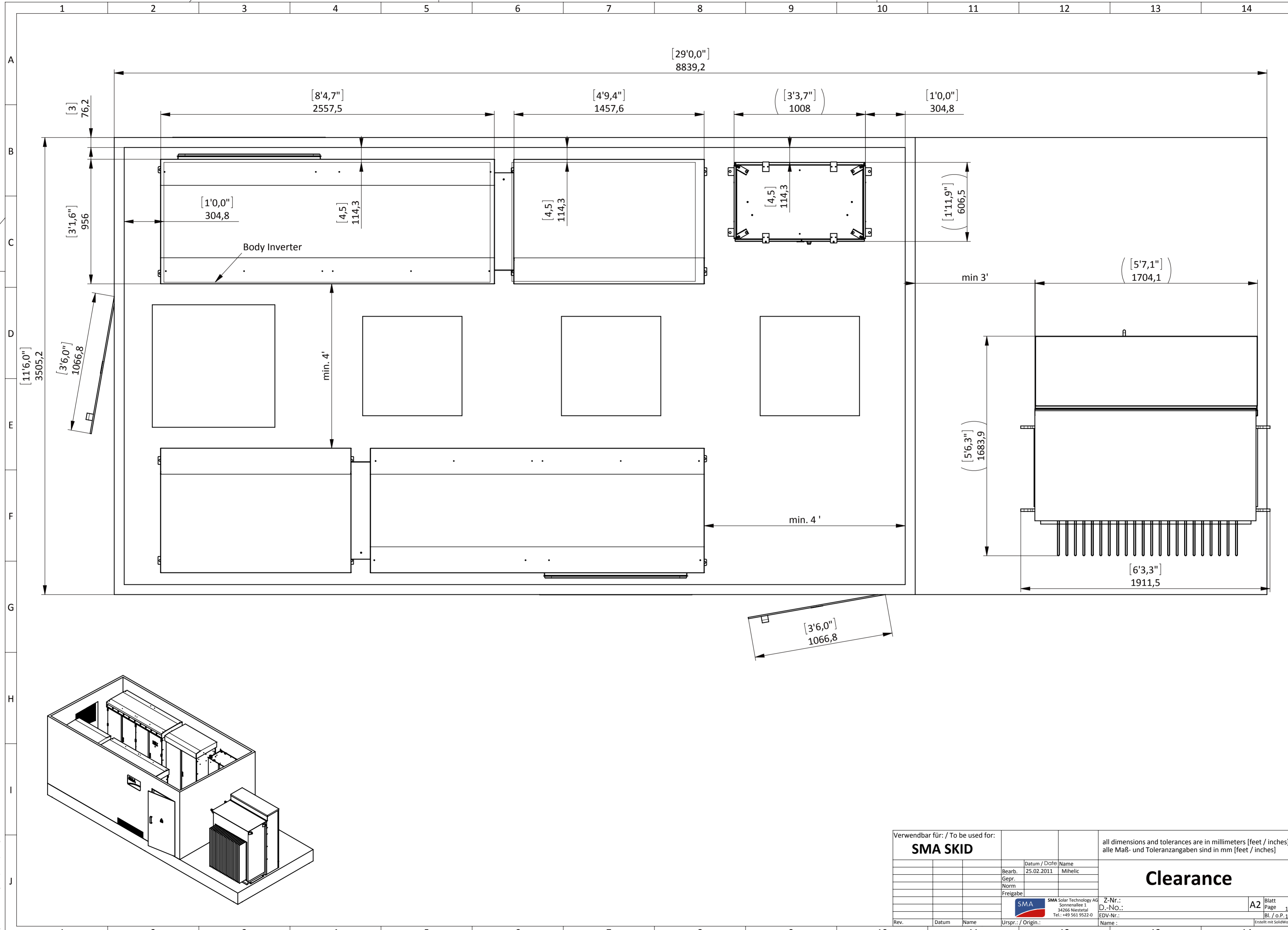

Weitergabe sowie Vervielfältigung dieses Urteils, die
 sowie auch auszudrücken, ist ausdrücklich untersagt und kann
 Alle Rechte für den Fall der Patentierung oder Gebrauchsmarkenerlangung vorbehalten.
 This document may not be copied, reproduced, disseminated or
 Anyone violating this regulation will be liable for any damages.
 All rights reserved in case of patent or patent registration.

Verwendbar für: / To be used for:			all dimensions and tolerances are in millimeters [feet / inches] alle Maß- und Toleranzangaben sind in mm [feet / inches]					
SMA SKID			<h1>Clearance</h1>					
	Datum / Date	Name				Z-Nr.: D.-No.: EDV-Nr.: Name:		
	Bearb.	Mihelic						
	Gepr.							
	Norm							
	Freigabe							
Rev.	Datum	Name	Urspr.: / Origin.:	SMA Solar Technology AG Sonnenallee 1 34266 Niestetal Tel.: +49 561 9522-0				
			Erstellt mit SolidWorks		A2 Blatt Page 1 Bl. / o.P. 1			

Terz-midle-frequency [kHz]	Soundpower-level L_{xpA} [dB _A]500kW	Soundpower-level L_{xpA} [dB _A]640kW	Soundpower-level L_{xpA} [dB _A]720kW	Soundpower-level L_{xpA} [dB _A]760kW	Soundpower-level L_{xpA} [dB _A]800kW
0,05	63,30	55,30	57,70	67,00	56,50
0,063	60,80	53,10	56,80	63,20	54,00
0,08	63,90	56,30	56,50	59,50	55,20
0,1	64,10	66,20	65,00	66,50	68,10
0,125	65,70	64,50	60,60	65,20	62,00
0,16	72,30	65,80	65,50	63,20	66,40
0,2	67,30	64,60	66,80	64,90	67,80
0,25	66,10	76,20	77,50	70,80	72,40
0,315	78,40	79,80	77,70	82,20	75,10
0,4	73,70	73,90	73,90	72,80	66,70
0,5	77,80	78,70	77,70	77,40	74,70
0,63	78,90	78,90	74,60	77,40	77,00
0,8	70,60	72,50	74,10	70,60	72,00
1	72,20	71,00	70,00	68,90	67,90
1,25	72,40	72,00	71,50	70,80	71,80
1,6	67,30	68,30	76,70	68,60	68,50
2	69,30	66,30	66,50	67,20	65,30
2,5	65,10	66,80	64,60	64,80	63,90
3,15	62,60	64,30	65,00	63,20	61,00
4,0	53,50	54,20	54,70	52,30	53,80
5,0	51,30	49,50	50,50	51,20	49,80
6,3	68,90	72,60	73,50	73,50	69,70

SC800CP at nominal power of 800 kW at 60 Hz

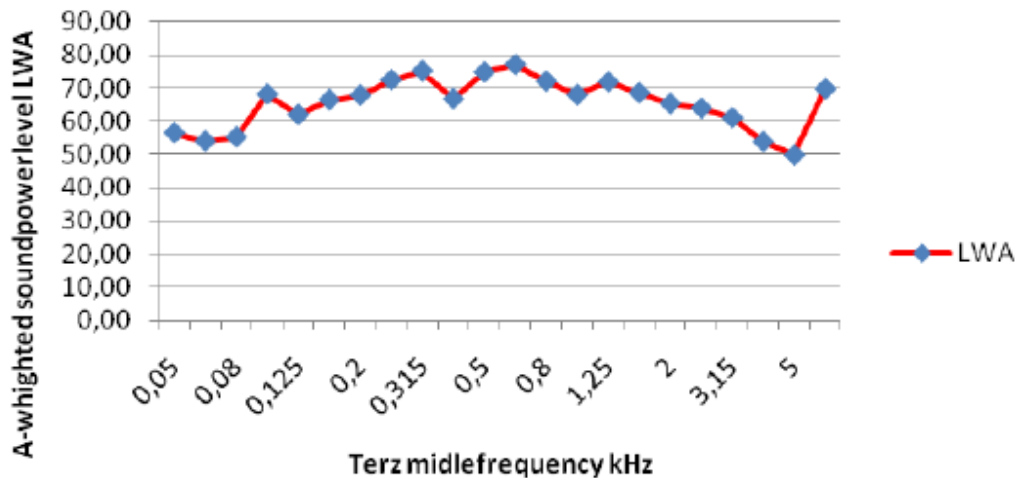

Figure B.1 SC800CP Inverter Sound Power Level as Provided by SMA. Note that the Header in the Table above Represents Various Inverter Models of CS###CP Series.

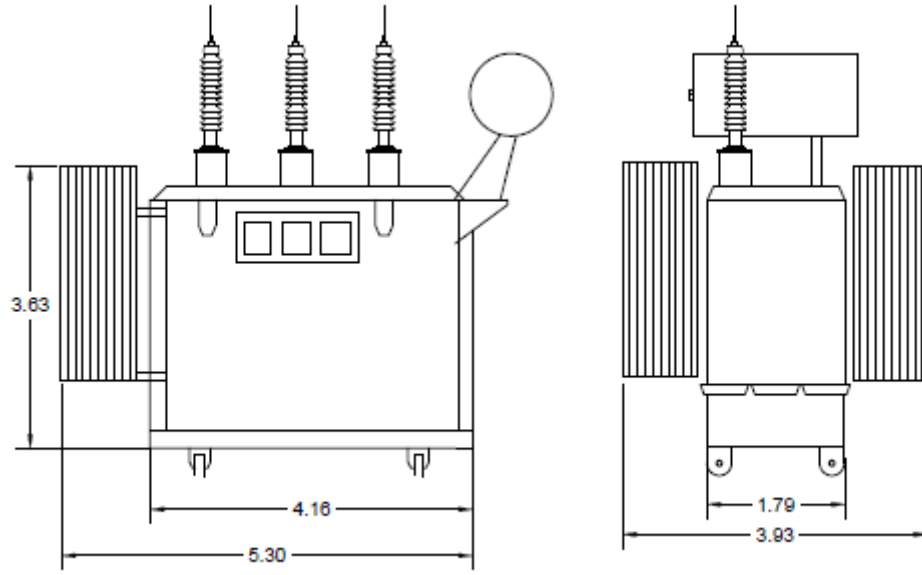

Figure B.2 115-kVA/10-MVA Substation Transformer Catalogue Dimensions (metres).

Estimated Frequency Spectra for Transformers

Transformer - 115kV/10MVA

From Handbook of Noise and Vibration Control (Crocker, 2007, page 1335-1336, Eq. 18 and Table 20)

Average LpA 70 dBA Based on NEMA TR1-1993 (R2000), Table 0-2
 Estimated surface area 58.7 m² Estimated based on similar transformer dimensions

Correction factors are in dB

Freq. (Hz)	31	63	125	250	500	1000	2000	4000	8000	Notes
C1	-11.0	-5.0	-3.0	-8.0	-8.0	-14.0	-19.0	-24.0	-31.0	Outdoors, indoors in mechanical room over 140 m ³ Indoors Serious Noise Problems
C2	-11	-2	3	-2	-2	-11	-19	-24	-31	
C3	-11	-2	3	2	2	-4	-9	-14	-21	

Sound Power Level calculated as $L_w = \text{Average LpA} + 10 \cdot \log(\text{Estimated surface area}) + C + 10$

Freq. (Hz)	31	63	125	250	500	1000	2000	4000	8000	Combined [dB]
C1 based [dB]	86.7	92.7	94.7	89.7	89.7	83.7	78.7	73.7	66.7	98.7
C2 based [dB]	86.7	95.7	100.7	95.7	95.7	86.7	78.7	73.7	66.7	103.8
C3 based [dB]	86.7	95.7	100.7	99.7	99.7	93.7	88.7	83.7	76.7	105.8

Resulting A-weighted sound power level

Freq. (Hz)	A-Weight	C1 based [dBA]	C2 based [dBA]	C2 based [dBA]
31	-39.4	47.3	56.3	61.3
63	-26.2	66.5	69.5	69.5
125	-16.1	78.6	84.6	84.6
250	-8.6	81.1	87.1	91.1
500	-3.2	86.5	92.5	96.5
1000	0	83.7	86.7	93.7
2000	1.2	79.9	79.9	89.9
4000	1	74.7	74.7	84.7
8000	-1.1	65.6	65.6	75.6
LwA [dBA]		90.1	95.0	99.9

 Used in the study

Figure B.3 Sound Power Level Calculation for 115-kV/10-MVA Substation Transformer.

Sound Power Level Calculation for SMA Sunny Central 800CP, 100% LOAD

Third octave, as provided		
Freq #	Freq (Hz)	LwA (dBA)
1	25	
2	31.5	
3	40	
4	50	56.5
5	63	54.0
6	80	55.2
7	100	68.1
8	125	62.0
9	160	66.4
10	200	67.8
11	250	72.4
12	315	75.1
13	400	66.7
14	500	74.7
15	630	77.0
16	800	72.0
17	1000	67.9
18	1250	71.8
19	1600	68.5
20	2000	65.3
21	2500	63.9
22	3150	61.0
23	4000	53.8
24	5000	49.8
25	6300	69.7
26	8000	
27	10000	
Total LwA		83.3

Full octave, as used in CADNA-A model			
Freq #	Freq (Hz)	LwA 1 inverter (dBA)	LwA 2 inverters (dBA)
	31.5		
5	63	60.1	63.1
8	125	70.9	73.9
11	250	77.5	80.5
14	500	79.3	82.3
17	1000	75.7	78.7
20	2000	71.1	74.1
23	4000	62.0	65.0
26	8000	69.7	72.7
Total LwA		83.3	86.3

$$10 \log \left(10^{\frac{56.5}{10}} + 10^{\frac{54.0}{10}} + 10^{\frac{55.2}{10}} \right) = 60.1 \text{ dBA}$$

$$10 \log \left(10^{\frac{60.1}{10}} + 10^{\frac{60.1}{10}} \right) = 63.1 \text{ dBA}$$

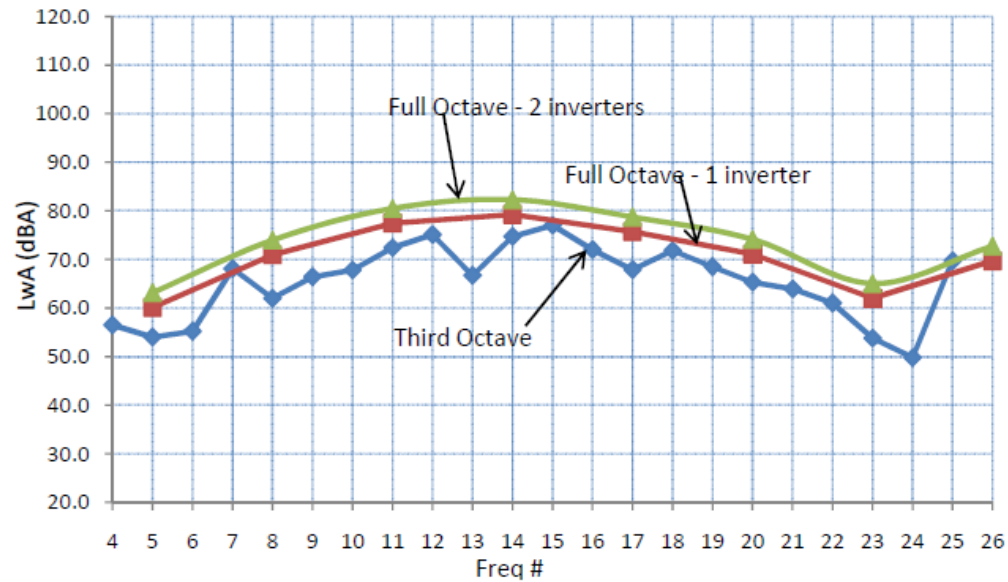

Figure B.4 Sound Power Level Calculation for SMA Sunny Central 800CP, 100% LOAD.

Estimated Frequency Spectra for Transformers

Transformer - 27.6kV/1.6MVA

From Handbook of Noise and Vibration Control (Crocker, 2007, page 1335-1336, Eq. 18 and Table 20)

Average LpA 61 dBA Based on NEMA TR1-1993 (R2000), Table 0-2
 Estimated surface area 14.872 m² Estimated based on client transformer drawings

Correction factors are in dB

Freq. (Hz)	31	63	125	250	500	1000	2000	4000	8000	Notes
C1	-11.0	-5.0	-3.0	-8.0	-8.0	-14.0	-19.0	-24.0	-31.0	Outdoors, indoors in mechanical room over 140 m ³ Indoors Serious Noise Problems
C2	-11	-2	3	-2	-2	-11	-19	-24	-31	
C3	-11	-2	3	2	2	-4	-9	-14	-21	

Sound Power Level calculated as $L_w = \text{Average LpA} + 10 \cdot \log(\text{Estimated surface area}) + C + 10$

Freq. (Hz)	31	63	125	250	500	1000	2000	4000	8000	Combined [dB]
C1 based [dB]	71.7	77.7	79.7	74.7	74.7	68.7	63.7	58.7	51.7	83.8
C2 based [dB]	71.7	80.7	85.7	80.7	80.7	71.7	63.7	58.7	51.7	88.8
C3 based [dB]	71.7	80.7	85.7	84.7	84.7	78.7	73.7	68.7	61.7	90.8

Resulting A-weighted sound power level

Freq. (Hz)	A-Weight	C1 based [dBA]	C2 based [dBA]	C2 based [dBA]
31	-39.4	32.3	41.3	46.3
63	-26.2	51.5	54.5	54.5
125	-16.1	63.6	69.6	69.6
250	-8.6	66.1	72.1	76.1
500	-3.2	71.5	77.5	81.5
1000	0	68.7	71.7	78.7
2000	1.2	64.9	64.9	74.9
4000	1	59.7	59.7	69.7
8000	-1.1	50.6	50.6	60.6
LwA [dBA]		75.1	80.1	84.9

 Used in the study

Figure B.5 Sound Power Level Calculation for 27.6-kV/1.6-MVA Cluster Transformer.

Appendix C

Points of Reception Coordinates and Noise Maps from CADNA-A

Table C.1 List of all receptors considered for the combined noise study from the three solar projects

ID	Description	UTM Coordinates NAD 83 Zone 17 (m)	
		X	Y
1	Existing	499023.9	5441174.5
2	Existing	499038.5	5443184.2
3	Existing	499228.9	5441297.5
4	Existing	499236.9	5441325.5
5	Existing	499242.9	5441269.5
6	Existing	499255.9	5441184.5
7	Existing	499265.9	5441128.5
8	Existing	499267.9	5441173.5
9	Vacant	499625.6	5441134.8
10	Vacant	499742.2	5441281.4
11	Existing	499771.9	5441080.5
12	Existing	499779.4	5442915.7
13	Existing	499787.9	5441161.5
14	Existing	499792.9	5442321.5
15	Existing	499792.9	5442404.5
16	Vacant	499852.9	5441296.4
17	Existing	499853.9	5443134.5
18	Existing	499854.9	5443170.6
19	Existing	499871.9	5442559.6
20	Existing	499871.9	5442559.6
21	Vacant	499886.1	5441238.3
22	Vacant	499888.2	5440274.6
23	Existing	499892.9	5443593.6
24	Vacant	499893.4	5441141.6
25	Existing	499893.9	5443614.6
26	Existing	499897.2	5442882.6
27	Existing	499897.2	5442882.6
28	Existing	499897.7	5442807.0
29	Existing	499897.7	5442807.0
30	Existing	500010.9	5443726.6
31	Existing	500035.9	5443709.6
32	Existing	500039.9	5443690.6
33	Existing	500518.9	5443721.6
34	Existing	500519.9	5441237.5
35	Existing	500522.9	5441169.5
36	Existing	500530.9	5443671.6

ID	Description	UTM Coordinates NAD 83 Zone 17 (m)	
		X	Y
37	Existing	500531.9	5441277.5
38	Existing	500535.9	5441260.5
39	Existing	500556.9	5441290.5
40	Vacant	500560.8	5443555.2
41	Existing	500590.9	5441276.5
42	Existing	500593.9	5441256.5
43	Vacant	500663.8	5443707.3
44	Existing	500732.9	5443953.6
45	Existing	500883.9	5441175.5
46	Existing	500922.0	5443686.3
47	Existing	500923.9	5441292.5
48	Existing	500959.9	5441231.5
49	Existing	500970.9	5441293.5
50	Existing	501067.9	5443687.6
51	Existing	501203.6	5443864.8
52	Existing	501289.8	5443828.6
53	Existing	501373.9	5443675.6
54	Vacant	501542.2	5441105.6
55	Vacant	501606.5	5441266.7
56	Vacant	501690.5	5443693.5
57	Vacant	501690.5	5443693.5
58	Existing	501758.0	5443606.6
59	Vacant	501802.8	5444102.2
60	Vacant	501802.8	5444102.2
61	Existing	501802.9	5443682.6
62	Existing	501882.0	5443681.6
63	Existing	502031.5	5443726.2
64	Vacant	502319.0	5443718.8
65	Existing	502836.4	5443716.6
66	Existing	502847.7	5443597.3
67	Vacant	503091.1	5443721.9
68	Vacant	503184.9	5443528.5

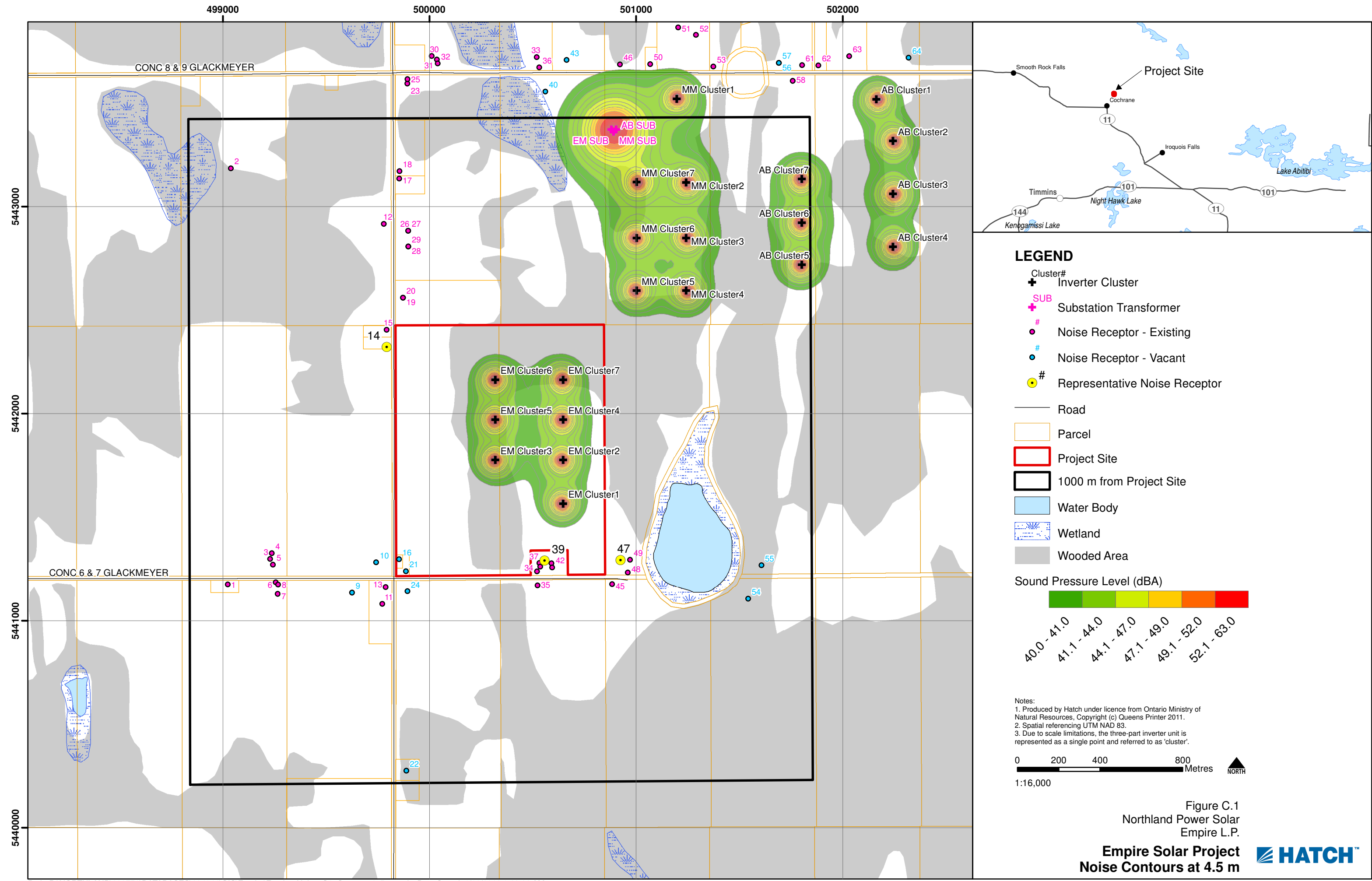

LEGEND

- Cluster#
- + Inverter Cluster
- SUB
- + Substation Transformer
- # Noise Receptor - Existing
- # Noise Receptor - Vacant
- # Representative Noise Receptor

- Road
- Parcel
- Project Site
- 1000 m from Project Site
- Water Body
- Wetland
- Wooded Area

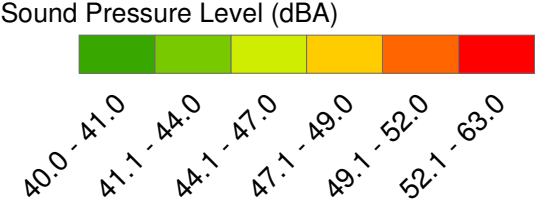

Notes:
 1. Produced by Hatch under licence from Ontario Ministry of Natural Resources, Copyright (c) Queens Printer 2011.
 2. Spatial referencing UTM NAD 83.
 3. Due to scale limitations, the three-part inverter unit is represented as a single point and referred to as 'cluster'.



Figure C.1
 Northland Power Solar
 Empire L.P.
**Empire Solar Project
 Noise Contours at 4.5 m**



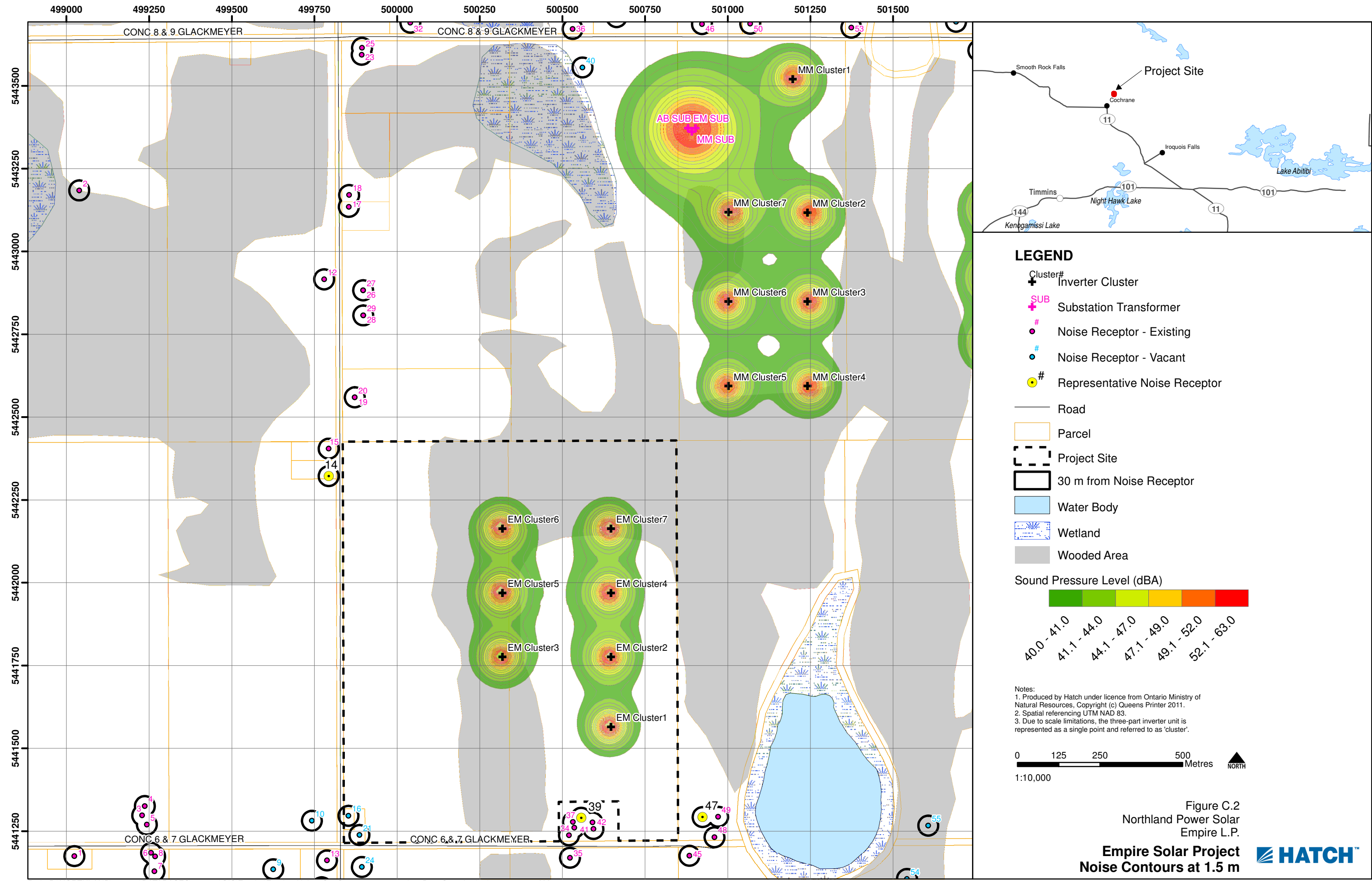

Appendix D

CADNA-A Sample Calculations

Configuration	
Parameter	Value
General	
Country	(user defined)
Max. Error (dB)	0.00
Max. Search Radius (m)	3000.00
Min. Dist Src to Rcvr	0.00
Partition	
Raster Factor	0.50
Max. Length of Section (m)	1000.00
Min. Length of Section (m)	1.00
Min. Length of Section (%)	0.00
Proj. Line Sources	On
Proj. Area Sources	On
Ref. Time	
Reference Time Day (min)	960.00
Reference Time Night (min)	480.00
Daytime Penalty (dB)	0.00
Recr. Time Penalty (dB)	0.00
Night-time Penalty (dB)	0.00
DTM	
Standard Height (m)	0.00
Model of Terrain	Triangulation
Reflection	
max. Order of Reflection	1
Search Radius Src	100.00
Search Radius Rcvr	100.00
Max. Distance Source - Rcvr	1000.00 1000.00
Min. Distance Rcvr - Reflector	1.00 1.00
Min. Distance Source - Reflector	0.10
Industrial (ISO 9613)	
Lateral Diffraction	some Obj
Obst. within Area Src do not shield	On
Screening	
	Excl. Ground Att. over Barrier
	Dz with limit (20/25)
Barrier Coefficients C1,2,3	3.0 20.0 0.0
Temperature (°C)	10
rel. Humidity (%)	70
Ground Absorption G	0.70
Wind Speed for Dir. (m/s)	3.0
Roads (RLS-90)	
Strictly acc. to RLS-90	
Railways (Schall 03)	
Strictly acc. to Schall 03 / Schall-Transrapid	
Aircraft (???)	
Strictly acc. to AzB	

Receiver

Name: 39.0

ID: 39.0

X: 500556.94

Y: 5441290.54

Z: 273.22

Point Source, ISO 9613, Name: "Ab_Sub115", ID: "Ab_Sub115"

Nr.	X (m)	Y (m)	Z (m)	Refl.	Freq. (Hz)	LxT dB(A)	LxN dB(A)	K0 (dB)	Dc (dB)	Adiv (dB)	Aatm (dB)	Agr (dB)	Afol (dB)	Ahous (dB)	Abar (dB)	Cmet (dB)	RL (dB)	LrT dB(A)	LrN dB(A)
1	500902.94	5443373.35	271.17	0	32	52.3	52.3	0.0	0.0	77.5	0.1	-5.6	0.0	0.0	0.0	0.0	-0.0	-19.6	-19.6
2	500902.94	5443373.35	271.17	0	63	71.5	71.5	0.0	0.0	77.5	0.3	-5.6	0.0	0.0	0.0	0.0	-0.0	-0.6	-0.6
3	500902.94	5443373.35	271.17	0	125	83.6	83.6	0.0	0.0	77.5	0.9	3.9	0.0	0.0	0.0	0.0	-0.0	1.4	1.4
4	500902.94	5443373.35	271.17	0	250	86.1	86.1	0.0	0.0	77.5	2.2	1.2	0.0	0.0	0.0	0.0	-0.0	5.3	5.3
5	500902.94	5443373.35	271.17	0	500	91.5	91.5	0.0	0.0	77.5	4.1	-1.7	0.0	0.0	0.0	0.0	-0.0	11.6	11.6
6	500902.94	5443373.35	271.17	0	1000	88.7	88.7	0.0	0.0	77.5	7.7	-1.7	0.0	0.0	0.0	0.0	-0.0	5.2	5.2
7	500902.94	5443373.35	271.17	0	2000	84.9	84.9	0.0	0.0	77.5	20.4	-1.7	0.0	0.0	0.0	0.0	-0.0	-11.3	-11.3
8	500902.94	5443373.35	271.17	0	4000	79.7	79.7	0.0	0.0	77.5	69.2	-1.7	0.0	0.0	0.0	0.0	-0.0	-65.3	-65.3
9	500902.94	5443373.35	271.17	0	8000	70.6	70.6	0.0	0.0	77.5	246.8	-1.7	0.0	0.0	0.0	0.0	-0.0	-252.0	-252.0

Point Source, ISO 9613, Name: "Ab_Switch", ID: "Ab_Switch"

Nr.	X (m)	Y (m)	Z (m)	Refl.	Freq. (Hz)	LxT dB(A)	LxN dB(A)	K0 (dB)	Dc (dB)	Adiv (dB)	Aatm (dB)	Agr (dB)	Afol (dB)	Ahous (dB)	Abar (dB)	Cmet (dB)	RL (dB)	LrT dB(A)	LrN dB(A)
1	501923.72	5443315.53	265.88	0	32	5.0	5.0	0.0	0.0	78.8	0.1	-5.7	0.0	0.0	0.0	0.0	-0.0	-68.1	-68.1
2	501923.72	5443315.53	265.88	0	63	5.0	5.0	0.0	0.0	78.8	0.3	-5.7	0.0	0.0	0.0	0.0	-0.0	-68.3	-68.3
3	501923.72	5443315.53	265.88	0	125	5.0	5.0	0.0	0.0	78.8	1.0	3.9	0.0	0.0	0.0	0.0	-0.0	-78.7	-78.7
4	501923.72	5443315.53	265.88	0	250	5.0	5.0	0.0	0.0	78.8	2.5	1.3	0.0	0.0	0.0	0.0	-0.0	-77.6	-77.6
5	501923.72	5443315.53	265.88	0	500	5.0	5.0	0.0	0.0	78.8	4.7	-1.7	0.0	0.0	0.0	0.0	-0.0	-76.8	-76.8
6	501923.72	5443315.53	265.88	0	1000	5.0	5.0	0.0	0.0	78.8	8.9	-1.7	0.0	0.0	0.0	0.0	-0.0	-81.0	-81.0
7	501923.72	5443315.53	265.88	0	2000	5.0	5.0	0.0	0.0	78.8	23.6	-1.7	0.0	0.0	0.0	0.0	-0.0	-95.7	-95.7
8	501923.72	5443315.53	265.88	0	4000	5.0	5.0	0.0	0.0	78.8	80.1	-1.7	0.0	0.0	0.0	0.0	-0.0	-152.1	-152.1
9	501923.72	5443315.53	265.88	0	8000	5.0	5.0	0.0	0.0	78.8	285.6	-1.7	0.0	0.0	0.0	0.0	-0.0	-357.6	-357.6

Point Source, ISO 9613, Name: "Ab_Inv1", ID: "Ab_Inv1"

Nr.	X (m)	Y (m)	Z (m)	Refl.	Freq. (Hz)	LxT dB(A)	LxN dB(A)	K0 (dB)	Dc (dB)	Adiv (dB)	Aatm (dB)	Agr (dB)	Afol (dB)	Ahous (dB)	Abar (dB)	Cmet (dB)	RL (dB)	LrT dB(A)	LrN dB(A)
1	502168.27	5443519.14	265.76	0	63	68.1	-88.0	0.0	0.0	79.8	0.3	-5.8	0.0	0.0	0.0	0.0	-0.0	-6.3	-88.0
2	502168.27	5443519.14	265.76	0	125	78.9	-88.0	0.0	0.0	79.8	1.1	4.2	0.0	0.0	0.0	0.0	-0.0	-6.2	-88.0
3	502168.27	5443519.14	265.76	0	250	85.5	-88.0	0.0	0.0	79.8	2.9	2.5	0.0	0.0	0.0	0.0	-0.0	0.3	-88.0
4	502168.27	5443519.14	265.76	0	500	87.3	-88.0	0.0	0.0	79.8	5.3	-1.3	0.0	0.0	0.0	0.0	-0.0	3.5	-88.0
5	502168.27	5443519.14	265.76	0	1000	83.7	-88.0	0.0	0.0	79.8	10.1	-1.7	0.0	0.0	0.0	0.0	-0.0	-4.4	-88.0
6	502168.27	5443519.14	265.76	0	2000	79.1	-88.0	0.0	0.0	79.8	26.6	-1.7	0.0	0.0	0.0	0.0	-0.0	-25.5	-88.0
7	502168.27	5443519.14	265.76	0	4000	70.0	-88.0	0.0	0.0	79.8	90.1	-1.7	0.0	0.0	0.0	0.0	-0.0	-98.2	-88.0
8	502168.27	5443519.14	265.76	0	8000	77.7	-88.0	0.0	0.0	79.8	321.4	-1.7	0.0	0.0	0.0	0.0	-0.0	-321.8	-88.0

Point Source, ISO 9613, Name: "Ab_Inv2", ID: "Ab_Inv2"

Nr.	X (m)	Y (m)	Z (m)	Refl.	Freq. (Hz)	LxT dB(A)	LxN dB(A)	K0 (dB)	Dc (dB)	Adiv (dB)	Aatm (dB)	Agr (dB)	Afol (dB)	Ahous (dB)	Abar (dB)	Cmet (dB)	RL (dB)	LrT dB(A)	LrN dB(A)
1	502248.67	5443316.74	267.67	0	63	68.1	-88.0	0.0	0.0	79.4	0.3	-5.8	0.0	0.0	0.0	0.0	-0.0	-5.9	-88.0
2	502248.67	5443316.74	267.67	0	125	78.9	-88.0	0.0	0.0	79.4	1.1	4.2	0.0	0.0	0.0	0.0	-0.0	-5.8	-88.0
3	502248.67	5443316.74	267.67	0	250	85.5	-88.0	0.0	0.0	79.4	2.8	2.5	0.0	0.0	0.0	0.0	-0.0	0.8	-88.0
4	502248.67	5443316.74	267.67	0	500	87.3	-88.0	0.0	0.0	79.4	5.1	-1.3	0.0	0.0	0.0	0.0	-0.0	4.1	-88.0
5	502248.67	5443316.74	267.67	0	1000	83.7	-88.0	0.0	0.0	79.4	9.7	-1.7	0.0	0.0	0.0	0.0	-0.0	-3.7	-88.0
6	502248.67	5443316.74	267.67	0	2000	79.1	-88.0	0.0	0.0	79.4	25.5	-1.7	0.0	0.0	0.0	0.0	-0.0	-24.1	-88.0
7	502248.67	5443316.74	267.67	0	4000	70.0	-88.0	0.0	0.0	79.4	86.5	-1.7	0.0	0.0	0.0	0.0	-0.0	-94.2	-88.0
8	502248.67	5443316.74	267.67	0	8000	77.7	-88.0	0.0	0.0	79.4	308.5	-1.7	0.0	0.0	0.0	0.0	-0.0	-308.5	-88.0

Point Source, ISO 9613, Name: "Ab_Inv3", ID: "Ab_Inv3"

Nr.	X (m)	Y (m)	Z (m)	Refl.	Freq. (Hz)	LxT dB(A)	LxN dB(A)	K0 (dB)	Dc (dB)	Adiv (dB)	Aatm (dB)	Agr (dB)	Afol (dB)	Ahous (dB)	Abar (dB)	Cmet (dB)	RL (dB)	LrT dB(A)	LrN dB(A)
1	502248.67	5443061.54	268.06	0	63	68.1	-88.0	0.0	0.0	78.8	0.3	-5.7	0.0	0.0	0.0	0.0	-0.0	-5.2	-88.0
2	502248.67	5443061.54	268.06	0	125	78.9	-88.0	0.0	0.0	78.8	1.0	4.2	0.0	0.0	0.0	0.0	-0.0	-5.1	-88.0
3	502248.67	5443061.54	268.06	0	250	85.5	-88.0	0.0	0.0	78.8	2.6	2.5	0.0	0.0	0.0	0.0	-0.0	1.6	-88.0

Point Source, ISO 9613, Name: "Ab_Inv3", ID: "Ab_Inv3"																			
Nr.	X	Y	Z	Ref.	Freq.	LxT	LxN	K0	Dc	Adiv	Aatm	Agr	Afol	Ahous	Abar	Cmet	RL	LrT	LrN
	(m)	(m)	(m)		(Hz)	dB(A)	dB(A)	(dB)	(dB)	(dB)	(dB)	(dB)	(dB)	(dB)	(dB)	(dB)	(dB)	dB(A)	dB(A)
4	502248.67	5443061.54	268.06	0	500	87.3	-88.0	0.0	0.0	78.8	4.7	-1.3	0.0	0.0	0.0	0.0	-0.0	5.1	-88.0
5	502248.67	5443061.54	268.06	0	1000	83.7	-88.0	0.0	0.0	78.8	9.0	-1.7	0.0	0.0	0.0	0.0	-0.0	-2.3	-88.0
6	502248.67	5443061.54	268.06	0	2000	79.1	-88.0	0.0	0.0	78.8	23.7	-1.7	0.0	0.0	0.0	0.0	-0.0	-21.6	-88.0
7	502248.67	5443061.54	268.06	0	4000	70.0	-88.0	0.0	0.0	78.8	80.3	-1.7	0.0	0.0	0.0	0.0	-0.0	-87.3	-88.0
8	502248.67	5443061.54	268.06	0	8000	77.7	-88.0	0.0	0.0	78.8	286.3	-1.7	0.0	0.0	0.0	0.0	-0.0	-285.6	-88.0

Point Source, ISO 9613, Name: "Ab_Inv4", ID: "Ab_Inv4"																			
Nr.	X	Y	Z	Ref.	Freq.	LxT	LxN	K0	Dc	Adiv	Aatm	Agr	Afol	Ahous	Abar	Cmet	RL	LrT	LrN
	(m)	(m)	(m)		(Hz)	dB(A)	dB(A)	(dB)	(dB)	(dB)	(dB)	(dB)	(dB)	(dB)	(dB)	(dB)	(dB)	dB(A)	dB(A)
1	502248.67	5442806.34	266.40	0	63	68.1	-88.0	0.0	0.0	78.1	0.3	-5.7	0.0	0.0	0.0	0.0	-0.0	-4.6	-88.0
2	502248.67	5442806.34	266.40	0	125	78.9	-88.0	0.0	0.0	78.1	0.9	4.2	0.0	0.0	0.0	0.0	-0.0	-4.3	-88.0
3	502248.67	5442806.34	266.40	0	250	85.5	-88.0	0.0	0.0	78.1	2.4	2.5	0.0	0.0	0.0	0.0	-0.0	2.5	-88.0
4	502248.67	5442806.34	266.40	0	500	87.3	-88.0	0.0	0.0	78.1	4.4	-1.3	0.0	0.0	0.0	0.0	-0.0	6.1	-88.0
5	502248.67	5442806.34	266.40	0	1000	83.7	-88.0	0.0	0.0	78.1	8.3	-1.7	0.0	0.0	0.0	0.0	-0.0	-1.0	-88.0
6	502248.67	5442806.34	266.40	0	2000	79.1	-88.0	0.0	0.0	78.1	21.9	-1.7	0.0	0.0	0.0	0.0	-0.0	-19.3	-88.0
7	502248.67	5442806.34	266.40	0	4000	70.0	-88.0	0.0	0.0	78.1	74.4	-1.7	0.0	0.0	0.0	0.0	-0.0	-80.8	-88.0
8	502248.67	5442806.34	266.40	0	8000	77.7	-88.0	0.0	0.0	78.1	265.5	-1.7	0.0	0.0	0.0	0.0	-0.0	-264.2	-88.0

Point Source, ISO 9613, Name: "Ab_Inv5", ID: "Ab_Inv5"																			
Nr.	X	Y	Z	Ref.	Freq.	LxT	LxN	K0	Dc	Adiv	Aatm	Agr	Afol	Ahous	Abar	Cmet	RL	LrT	LrN
	(m)	(m)	(m)		(Hz)	dB(A)	dB(A)	(dB)	(dB)	(dB)	(dB)	(dB)	(dB)	(dB)	(dB)	(dB)	(dB)	dB(A)	dB(A)
1	501796.03	5442720.01	263.02	0	63	68.1	-88.0	0.0	0.0	76.5	0.2	-5.7	0.0	0.0	0.0	0.0	-0.0	-3.0	-88.0
2	501796.03	5442720.01	263.02	0	125	78.9	-88.0	0.0	0.0	76.5	0.8	4.2	0.0	0.0	0.0	0.0	-0.0	-2.6	-88.0
3	501796.03	5442720.01	263.02	0	250	85.5	-88.0	0.0	0.0	76.5	2.0	2.5	0.0	0.0	0.0	0.0	-0.0	4.4	-88.0
4	501796.03	5442720.01	263.02	0	500	87.3	-88.0	0.0	0.0	76.5	3.6	-1.3	0.0	0.0	0.0	0.0	-0.0	8.4	-88.0
5	501796.03	5442720.01	263.02	0	1000	83.7	-88.0	0.0	0.0	76.5	6.9	-1.7	0.0	0.0	0.0	0.0	-0.0	1.9	-88.0
6	501796.03	5442720.01	263.02	0	2000	79.1	-88.0	0.0	0.0	76.5	18.3	-1.7	0.0	0.0	0.0	0.0	-0.0	-14.0	-88.0
7	501796.03	5442720.01	263.02	0	4000	70.0	-88.0	0.0	0.0	76.5	62.0	-1.7	0.0	0.0	0.0	0.0	-0.0	-66.8	-88.0
8	501796.03	5442720.01	263.02	0	8000	77.7	-88.0	0.0	0.0	76.5	221.1	-1.7	0.0	0.0	0.0	0.0	-0.0	-218.3	-88.0

Point Source, ISO 9613, Name: "Ab_Inv6", ID: "Ab_Inv6"																			
Nr.	X	Y	Z	Ref.	Freq.	LxT	LxN	K0	Dc	Adiv	Aatm	Agr	Afol	Ahous	Abar	Cmet	RL	LrT	LrN
	(m)	(m)	(m)		(Hz)	dB(A)	dB(A)	(dB)	(dB)	(dB)	(dB)	(dB)	(dB)	(dB)	(dB)	(dB)	(dB)	dB(A)	dB(A)
1	501796.03	5442922.41	263.76	0	63	68.1	-88.0	0.0	0.0	77.2	0.3	-5.7	0.0	0.0	0.0	0.0	-0.0	-3.7	-88.0
2	501796.03	5442922.41	263.76	0	125	78.9	-88.0	0.0	0.0	77.2	0.8	4.2	0.0	0.0	0.0	0.0	-0.0	-3.4	-88.0
3	501796.03	5442922.41	263.76	0	250	85.5	-88.0	0.0	0.0	77.2	2.1	2.5	0.0	0.0	0.0	0.0	-0.0	3.6	-88.0
4	501796.03	5442922.41	263.76	0	500	87.3	-88.0	0.0	0.0	77.2	3.9	-1.3	0.0	0.0	0.0	0.0	-0.0	7.4	-88.0
5	501796.03	5442922.41	263.76	0	1000	83.7	-88.0	0.0	0.0	77.2	7.5	-1.7	0.0	0.0	0.0	0.0	-0.0	0.7	-88.0
6	501796.03	5442922.41	263.76	0	2000	79.1	-88.0	0.0	0.0	77.2	19.8	-1.7	0.0	0.0	0.0	0.0	-0.0	-16.2	-88.0
7	501796.03	5442922.41	263.76	0	4000	70.0	-88.0	0.0	0.0	77.2	67.1	-1.7	0.0	0.0	0.0	0.0	-0.0	-72.7	-88.0
8	501796.03	5442922.41	263.76	0	8000	77.7	-88.0	0.0	0.0	77.2	239.5	-1.7	0.0	0.0	0.0	0.0	-0.0	-237.3	-88.0

Point Source, ISO 9613, Name: "Ab_Inv7", ID: "Ab_Inv7"																			
Nr.	X	Y	Z	Ref.	Freq.	LxT	LxN	K0	Dc	Adiv	Aatm	Agr	Afol	Ahous	Abar	Cmet	RL	LrT	LrN
	(m)	(m)	(m)		(Hz)	dB(A)	dB(A)	(dB)	(dB)	(dB)	(dB)	(dB)	(dB)	(dB)	(dB)	(dB)	(dB)	dB(A)	dB(A)
1	501796.03	5443133.61	264.09	0	63	68.1	-88.0	0.0	0.0	77.9	0.3	-5.7	0.0	0.0	0.0	0.0	-0.0	-4.4	-88.0
2	501796.03	5443133.61	264.09	0	125	78.9	-88.0	0.0	0.0	77.9	0.9	4.2	0.0	0.0	0.0	0.0	-0.0	-4.1	-88.0
3	501796.03	5443133.61	264.09	0	250	85.5	-88.0	0.0	0.0	77.9	2.3	2.5	0.0	0.0	0.0	0.0	-0.0	2.7	-88.0
4	501796.03	5443133.61	264.09	0	500	87.3	-88.0	0.0	0.0	77.9	4.3	-1.3	0.0	0.0	0.0	0.0	-0.0	6.4	-88.0
5	501796.03	5443133.61	264.09	0	1000	83.7	-88.0	0.0	0.0	77.9	8.1	-1.7	0.0	0.0	0.0	0.0	-0.0	-0.7	-88.0
6	501796.03	5443133.61	264.09	0	2000	79.1	-88.0	0.0	0.0	77.9	21.5	-1.7	0.0	0.0	0.0	0.0	-0.0	-18.6	-88.0
7	501796.03	5443133.61	264.09	0	4000	70.0	-88.0	0.0	0.0	77.9	72.8	-1.7	0.0	0.0	0.0	0.0	-0.0	-79.0	-88.0
8	501796.03	5443133.61	264.09	0	8000	77.7	-88.0	0.0	0.0	77.9	259.6	-1.7	0.0	0.0	0.0	0.0	-0.0	-258.1	-88.0

Point Source, ISO 9613, Name: "Ab_Trans1", ID: "Ab_Trans1"																			
Nr.	X	Y	Z	Ref.	Freq.	LxT	LxN	K0	Dc	Adiv	Aatm	Agr	Afol	Ahous	Abar	Cmet	RL	LrT	LrN
	(m)	(m)	(m)		(Hz)	dB(A)	dB(A)	(dB)	(dB)	(dB)	(dB)	(dB)	(dB)	(dB)	(dB)	(dB)	(dB)	dB(A)	dB(A)
1	502162.77	5443519.64	265.70	0	32	37.3	37.3	0.0	0.0	79.8	0.1	-5.8	0.0	0.0	0.0	0.0	-0.0	-36.8	-36.8
2	502162.77	5443519.64	265.70	0	63	56.5	56.5	0.0	0.0	79.8	0.3	-5.8	0.0	0.0	0.0	0.0	-0.0	-17.8	-17.8
3	502162.77	5443519.64	265.70	0	125	68.6	68.6	0.0	0.0	79.8	1.1	4.2	0.0	0.0	0.0	0.0	-0.0	-16.5	-16.5
4	502162.77	5443519.64	265.70	0	250	71.1	71.1	0.0	0.0	79.8	2.9	2.5	0.0	0.0	0.0	0.0	-0.0	-14.1	-14.1
5	502162.77	5443519.64	265.70	0	500	76.5	76.5	0.0	0.0	79.8	5.3	-1.3	0.0	0.0	0.0	0.0	-0.0	-7.3	-7.3
6	502162.77	5443519.64	265.70	0	1000	73.7	73.7	0.0	0.0	79.8	10.1	-1.7	0.0	0.0	0.0	0.0	-0.0	-14.4	-14.4

Point Source, ISO 9613, Name: "Ab_Trans1", ID: "Ab_Trans1"																			
Nr.	X	Y	Z	Refl.	Freq.	LxT	LxN	K0	Dc	Adiv	Aatm	Agr	Afol	Ahous	Abar	Cmet	RL	LrT	LrN
	(m)	(m)	(m)		(Hz)	dB(A)	dB(A)	(dB)	(dB)	(dB)	(dB)	(dB)	(dB)	(dB)	(dB)	(dB)	(dB)	dB(A)	dB(A)
7	502162.77	5443519.64	265.70	0	2000	69.9	69.9	0.0	0.0	79.8	26.6	-1.7	0.0	0.0	0.0	0.0	-0.0	-34.7	-34.7
8	502162.77	5443519.64	265.70	0	4000	64.7	64.7	0.0	0.0	79.8	90.0	-1.7	0.0	0.0	0.0	0.0	-0.0	-103.4	-103.4
9	502162.77	5443519.64	265.70	0	8000	55.6	55.6	0.0	0.0	79.8	321.1	-1.7	0.0	0.0	0.0	0.0	-0.0	-343.6	-343.6

Point Source, ISO 9613, Name: "Ab_Trans2", ID: "Ab_Trans2"																			
Nr.	X	Y	Z	Refl.	Freq.	LxT	LxN	K0	Dc	Adiv	Aatm	Agr	Afol	Ahous	Abar	Cmet	RL	LrT	LrN
	(m)	(m)	(m)		(Hz)	dB(A)	dB(A)	(dB)	(dB)	(dB)	(dB)	(dB)	(dB)	(dB)	(dB)	(dB)	(dB)	dB(A)	dB(A)
1	502243.17	5443317.24	267.60	0	32	37.3	37.3	0.0	0.0	79.4	0.1	-5.8	0.0	0.0	0.0	0.0	-0.0	-36.4	-36.4
2	502243.17	5443317.24	267.60	0	63	56.5	56.5	0.0	0.0	79.4	0.3	-5.8	0.0	0.0	0.0	0.0	-0.0	-17.5	-17.5
3	502243.17	5443317.24	267.60	0	125	68.6	68.6	0.0	0.0	79.4	1.1	4.2	0.0	0.0	0.0	0.0	-0.0	-16.1	-16.1
4	502243.17	5443317.24	267.60	0	250	71.1	71.1	0.0	0.0	79.4	2.8	2.5	0.0	0.0	0.0	0.0	-0.0	-13.6	-13.6
5	502243.17	5443317.24	267.60	0	500	76.5	76.5	0.0	0.0	79.4	5.1	-1.3	0.0	0.0	0.0	0.0	-0.0	-6.7	-6.7
6	502243.17	5443317.24	267.60	0	1000	73.7	73.7	0.0	0.0	79.4	9.6	-1.7	0.0	0.0	0.0	0.0	-0.0	-13.7	-13.7
7	502243.17	5443317.24	267.60	0	2000	69.9	69.9	0.0	0.0	79.4	25.5	-1.7	0.0	0.0	0.0	0.0	-0.0	-33.3	-33.3
8	502243.17	5443317.24	267.60	0	4000	64.7	64.7	0.0	0.0	79.4	86.4	-1.7	0.0	0.0	0.0	0.0	-0.0	-99.4	-99.4
9	502243.17	5443317.24	267.60	0	8000	55.6	55.6	0.0	0.0	79.4	308.2	-1.7	0.0	0.0	0.0	0.0	-0.0	-330.3	-330.3

Point Source, ISO 9613, Name: "Ab_Trans3", ID: "Ab_Trans3"																			
Nr.	X	Y	Z	Refl.	Freq.	LxT	LxN	K0	Dc	Adiv	Aatm	Agr	Afol	Ahous	Abar	Cmet	RL	LrT	LrN
	(m)	(m)	(m)		(Hz)	dB(A)	dB(A)	(dB)	(dB)	(dB)	(dB)	(dB)	(dB)	(dB)	(dB)	(dB)	(dB)	dB(A)	dB(A)
1	502243.17	5443062.04	267.99	0	32	37.3	37.3	0.0	0.0	78.8	0.1	-5.7	0.0	0.0	0.0	0.0	-0.0	-35.8	-35.8
2	502243.17	5443062.04	267.99	0	63	56.5	56.5	0.0	0.0	78.8	0.3	-5.7	0.0	0.0	0.0	0.0	-0.0	-16.8	-16.8
3	502243.17	5443062.04	267.99	0	125	68.6	68.6	0.0	0.0	78.8	1.0	4.2	0.0	0.0	0.0	0.0	-0.0	-15.4	-15.4
4	502243.17	5443062.04	267.99	0	250	71.1	71.1	0.0	0.0	78.8	2.5	2.6	0.0	0.0	0.0	0.0	-0.0	-12.8	-12.8
5	502243.17	5443062.04	267.99	0	500	76.5	76.5	0.0	0.0	78.8	4.7	-1.3	0.0	0.0	0.0	0.0	-0.0	-5.7	-5.7
6	502243.17	5443062.04	267.99	0	1000	73.7	73.7	0.0	0.0	78.8	9.0	-1.7	0.0	0.0	0.0	0.0	-0.0	-12.3	-12.3
7	502243.17	5443062.04	267.99	0	2000	69.9	69.9	0.0	0.0	78.8	23.6	-1.7	0.0	0.0	0.0	0.0	-0.0	-30.8	-30.8
8	502243.17	5443062.04	267.99	0	4000	64.7	64.7	0.0	0.0	78.8	80.1	-1.7	0.0	0.0	0.0	0.0	-0.0	-92.5	-92.5
9	502243.17	5443062.04	267.99	0	8000	55.6	55.6	0.0	0.0	78.8	285.9	-1.7	0.0	0.0	0.0	0.0	-0.0	-307.3	-307.3

Point Source, ISO 9613, Name: "Ab_Trans4", ID: "Ab_Trans4"																			
Nr.	X	Y	Z	Refl.	Freq.	LxT	LxN	K0	Dc	Adiv	Aatm	Agr	Afol	Ahous	Abar	Cmet	RL	LrT	LrN
	(m)	(m)	(m)		(Hz)	dB(A)	dB(A)	(dB)	(dB)	(dB)	(dB)	(dB)	(dB)	(dB)	(dB)	(dB)	(dB)	dB(A)	dB(A)
1	502243.17	5442806.84	266.35	0	32	37.3	37.3	0.0	0.0	78.1	0.1	-5.7	0.0	0.0	0.0	0.0	-0.0	-35.2	-35.2
2	502243.17	5442806.84	266.35	0	63	56.5	56.5	0.0	0.0	78.1	0.3	-5.7	0.0	0.0	0.0	0.0	-0.0	-16.2	-16.2
3	502243.17	5442806.84	266.35	0	125	68.6	68.6	0.0	0.0	78.1	0.9	4.2	0.0	0.0	0.0	0.0	-0.0	-14.6	-14.6
4	502243.17	5442806.84	266.35	0	250	71.1	71.1	0.0	0.0	78.1	2.4	2.6	0.0	0.0	0.0	0.0	-0.0	-11.9	-11.9
5	502243.17	5442806.84	266.35	0	500	76.5	76.5	0.0	0.0	78.1	4.4	-1.3	0.0	0.0	0.0	0.0	-0.0	-4.7	-4.7
6	502243.17	5442806.84	266.35	0	1000	73.7	73.7	0.0	0.0	78.1	8.3	-1.7	0.0	0.0	0.0	0.0	-0.0	-11.0	-11.0
7	502243.17	5442806.84	266.35	0	2000	69.9	69.9	0.0	0.0	78.1	21.9	-1.7	0.0	0.0	0.0	0.0	-0.0	-28.4	-28.4
8	502243.17	5442806.84	266.35	0	4000	64.7	64.7	0.0	0.0	78.1	74.3	-1.7	0.0	0.0	0.0	0.0	-0.0	-86.0	-86.0
9	502243.17	5442806.84	266.35	0	8000	55.6	55.6	0.0	0.0	78.1	265.1	-1.7	0.0	0.0	0.0	0.0	-0.0	-285.9	-285.9

Point Source, ISO 9613, Name: "Ab_Trans5", ID: "Ab_Trans5"																			
Nr.	X	Y	Z	Refl.	Freq.	LxT	LxN	K0	Dc	Adiv	Aatm	Agr	Afol	Ahous	Abar	Cmet	RL	LrT	LrN
	(m)	(m)	(m)		(Hz)	dB(A)	dB(A)	(dB)	(dB)	(dB)	(dB)	(dB)	(dB)	(dB)	(dB)	(dB)	(dB)	dB(A)	dB(A)
1	501801.53	5442719.51	263.03	0	32	37.3	37.3	0.0	0.0	76.5	0.1	-5.7	0.0	0.0	0.0	0.0	-0.0	-33.6	-33.6
2	501801.53	5442719.51	263.03	0	63	56.5	56.5	0.0	0.0	76.5	0.2	-5.7	0.0	0.0	0.0	0.0	-0.0	-14.6	-14.6
3	501801.53	5442719.51	263.03	0	125	68.6	68.6	0.0	0.0	76.5	0.8	4.2	0.0	0.0	0.0	0.0	-0.0	-13.0	-13.0
4	501801.53	5442719.51	263.03	0	250	71.1	71.1	0.0	0.0	76.5	2.0	2.6	0.0	0.0	0.0	0.0	-0.0	-10.0	-10.0
5	501801.53	5442719.51	263.03	0	500	76.5	76.5	0.0	0.0	76.5	3.6	-1.2	0.0	0.0	0.0	0.0	-0.0	-2.5	-2.5
6	501801.53	5442719.51	263.03	0	1000	73.7	73.7	0.0	0.0	76.5	6.9	-1.7	0.0	0.0	0.0	0.0	-0.0	-8.1	-8.1
7	501801.53	5442719.51	263.03	0	2000	69.9	69.9	0.0	0.0	76.5	18.3	-1.7	0.0	0.0	0.0	0.0	-0.0	-23.3	-23.3
8	501801.53	5442719.51	263.03	0	4000	64.7	64.7	0.0	0.0	76.5	62.1	-1.7	0.0	0.0	0.0	0.0	-0.0	-72.3	-72.3
9	501801.53	5442719.51	263.03	0	8000	55.6	55.6	0.0	0.0	76.5	221.5	-1.7	0.0	0.0	0.0	0.0	-0.0	-240.8	-240.8

Point Source, ISO 9613, Name: "Ab_Trans6", ID: "Ab_Trans6"																			
Nr.	X	Y	Z	Refl.	Freq.	LxT	LxN	K0	Dc	Adiv	Aatm	Agr	Afol	Ahous	Abar	Cmet	RL	LrT	LrN
	(m)	(m)	(m)		(Hz)	dB(A)	dB(A)	(dB)	(dB)	(dB)	(dB)	(dB)	(dB)	(dB)	(dB)	(dB)	(dB)	dB(A)	dB(A)
1	501801.53	5442921.91	263.79	0	32	37.3	37.3	0.0	0.0	77.2	0.1	-5.7	0.0	0.0	0.0	0.0	-0.0	-34.3	-34.3
2	501801.53	5442921.91	263.79	0	63	56.5	56.5	0.0	0.0	77.2	0.3	-5.7	0.0	0.0	0.0	0.0	-0.0	-15.3	-15.3
3	501801.53	5442921.91	263.79	0	125	68.6	68.6	0.0	0.0	77.2	0.8	4.2	0.0	0.0	0.0	0.0	-0.0	-13.7	-13.7
4	501801.53	5442921.91	263.79	0	250	71.1	71.1	0.0	0.0	77.2	2.1	2.6	0.0	0.0	0.0	0.0	-0.0	-10.9	-10.9

Point Source, ISO 9613, Name: "Ab_Trans6", ID: "Ab_Trans6"																			
Nr.	X	Y	Z	Refl.	Freq.	LxT	LxN	K0	Dc	Adiv	Aatm	Agr	Afol	Ahous	Abar	Cmet	RL	LrT	LrN
	(m)	(m)	(m)		(Hz)	dB(A)	dB(A)	(dB)	(dB)	(dB)	(dB)	(dB)	(dB)	(dB)	(dB)	(dB)	(dB)	dB(A)	dB(A)
5	501801.53	5442921.91	263.79	0	500	76.5	76.5	0.0	0.0	77.2	4.0	-1.3	0.0	0.0	0.0	0.0	-0.0	-3.4	-3.4
6	501801.53	5442921.91	263.79	0	1000	73.7	73.7	0.0	0.0	77.2	7.5	-1.7	0.0	0.0	0.0	0.0	-0.0	-9.4	-9.4
7	501801.53	5442921.91	263.79	0	2000	69.9	69.9	0.0	0.0	77.2	19.8	-1.7	0.0	0.0	0.0	0.0	-0.0	-25.5	-25.5
8	501801.53	5442921.91	263.79	0	4000	64.7	64.7	0.0	0.0	77.2	67.2	-1.7	0.0	0.0	0.0	0.0	-0.0	-78.1	-78.1
9	501801.53	5442921.91	263.79	0	8000	55.6	55.6	0.0	0.0	77.2	239.8	-1.7	0.0	0.0	0.0	0.0	-0.0	-259.8	-259.8

Point Source, ISO 9613, Name: "Ab_Trans7", ID: "Ab_Trans7"																			
Nr.	X	Y	Z	Refl.	Freq.	LxT	LxN	K0	Dc	Adiv	Aatm	Agr	Afol	Ahous	Abar	Cmet	RL	LrT	LrN
	(m)	(m)	(m)		(Hz)	dB(A)	dB(A)	(dB)	(dB)	(dB)	(dB)	(dB)	(dB)	(dB)	(dB)	(dB)	(dB)	dB(A)	dB(A)
1	501801.53	5443133.11	264.12	0	32	37.3	37.3	0.0	0.0	77.9	0.1	-5.7	0.0	0.0	0.0	0.0	-0.0	-35.0	-35.0
2	501801.53	5443133.11	264.12	0	63	56.5	56.5	0.0	0.0	77.9	0.3	-5.7	0.0	0.0	0.0	0.0	-0.0	-16.0	-16.0
3	501801.53	5443133.11	264.12	0	125	68.6	68.6	0.0	0.0	77.9	0.9	4.2	0.0	0.0	0.0	0.0	-0.0	-14.5	-14.5
4	501801.53	5443133.11	264.12	0	250	71.1	71.1	0.0	0.0	77.9	2.3	2.6	0.0	0.0	0.0	0.0	-0.0	-11.7	-11.7
5	501801.53	5443133.11	264.12	0	500	76.5	76.5	0.0	0.0	77.9	4.3	-1.3	0.0	0.0	0.0	0.0	-0.0	-4.5	-4.5
6	501801.53	5443133.11	264.12	0	1000	73.7	73.7	0.0	0.0	77.9	8.1	-1.7	0.0	0.0	0.0	0.0	-0.0	-10.7	-10.7
7	501801.53	5443133.11	264.12	0	2000	69.9	69.9	0.0	0.0	77.9	21.5	-1.7	0.0	0.0	0.0	0.0	-0.0	-27.8	-27.8
8	501801.53	5443133.11	264.12	0	4000	64.7	64.7	0.0	0.0	77.9	72.9	-1.7	0.0	0.0	0.0	0.0	-0.0	-84.4	-84.4
9	501801.53	5443133.11	264.12	0	8000	55.6	55.6	0.0	0.0	77.9	259.9	-1.7	0.0	0.0	0.0	0.0	-0.0	-280.5	-280.5

Point Source, ISO 9613, Name: "Em_Sub115", ID: "Em_Sub115"																			
Nr.	X	Y	Z	Refl.	Freq.	LxT	LxN	K0	Dc	Adiv	Aatm	Agr	Afol	Ahous	Abar	Cmet	RL	LrT	LrN
	(m)	(m)	(m)		(Hz)	dB(A)	dB(A)	(dB)	(dB)	(dB)	(dB)	(dB)	(dB)	(dB)	(dB)	(dB)	(dB)	dB(A)	dB(A)
1	500880.48	5443373.35	271.15	0	32	52.3	52.3	0.0	0.0	77.5	0.1	-5.6	0.0	0.0	0.0	0.0	-0.0	-19.6	-19.6
2	500880.48	5443373.35	271.15	0	63	71.5	71.5	0.0	0.0	77.5	0.3	-5.6	0.0	0.0	0.0	0.0	-0.0	-0.6	-0.6
3	500880.48	5443373.35	271.15	0	125	83.6	83.6	0.0	0.0	77.5	0.9	3.9	0.0	0.0	0.0	0.0	-0.0	1.4	1.4
4	500880.48	5443373.35	271.15	0	250	86.1	86.1	0.0	0.0	77.5	2.2	1.2	0.0	0.0	0.0	0.0	-0.0	5.3	5.3
5	500880.48	5443373.35	271.15	0	500	91.5	91.5	0.0	0.0	77.5	4.1	-1.7	0.0	0.0	0.0	0.0	-0.0	11.6	11.6
6	500880.48	5443373.35	271.15	0	1000	88.7	88.7	0.0	0.0	77.5	7.7	-1.7	0.0	0.0	0.0	0.0	-0.0	5.2	5.2
7	500880.48	5443373.35	271.15	0	2000	84.9	84.9	0.0	0.0	77.5	20.4	-1.7	0.0	0.0	0.0	0.0	-0.0	-11.3	-11.3
8	500880.48	5443373.35	271.15	0	4000	79.7	79.7	0.0	0.0	77.5	69.1	-1.7	0.0	0.0	0.0	0.0	-0.0	-65.1	-65.1
9	500880.48	5443373.35	271.15	0	8000	70.6	70.6	0.0	0.0	77.5	246.4	-1.7	0.0	0.0	0.0	0.0	-0.0	-251.5	-251.5

Point Source, ISO 9613, Name: "Em_Switch", ID: "Em_Switch"																			
Nr.	X	Y	Z	Refl.	Freq.	LxT	LxN	K0	Dc	Adiv	Aatm	Agr	Afol	Ahous	Abar	Cmet	RL	LrT	LrN
	(m)	(m)	(m)		(Hz)	dB(A)	dB(A)	(dB)	(dB)	(dB)	(dB)	(dB)	(dB)	(dB)	(dB)	(dB)	(dB)	dB(A)	dB(A)
1	500773.85	5442311.59	263.50	0	32	5.0	5.0	0.0	0.0	71.4	0.0	-5.3	0.0	0.0	4.8	0.0	-0.0	-65.9	-65.9
2	500773.85	5442311.59	263.50	0	63	5.0	5.0	0.0	0.0	71.4	0.1	-5.3	0.0	0.0	4.8	0.0	-0.0	-66.0	-66.0
3	500773.85	5442311.59	263.50	0	125	5.0	5.0	0.0	0.0	71.4	0.4	3.9	0.0	0.0	0.9	0.0	-0.0	-71.6	-71.6
4	500773.85	5442311.59	263.50	0	250	5.0	5.0	0.0	0.0	71.4	1.1	1.4	0.0	0.0	3.4	0.0	-0.0	-72.2	-72.2
5	500773.85	5442311.59	263.50	0	500	5.0	5.0	0.0	0.0	71.4	2.0	-1.6	0.0	0.0	4.8	0.0	-0.0	-71.6	-71.6
6	500773.85	5442311.59	263.50	0	1000	5.0	5.0	0.0	0.0	71.4	3.8	-1.6	0.0	0.0	4.8	0.0	-0.0	-73.4	-73.4
7	500773.85	5442311.59	263.50	0	2000	5.0	5.0	0.0	0.0	71.4	10.1	-1.6	0.0	0.0	4.8	0.0	-0.0	-79.6	-79.6
8	500773.85	5442311.59	263.50	0	4000	5.0	5.0	0.0	0.0	71.4	34.2	-1.6	0.0	0.0	4.8	0.0	-0.0	-103.8	-103.8
9	500773.85	5442311.59	263.50	0	8000	5.0	5.0	0.0	0.0	71.4	122.0	-1.6	0.0	0.0	4.8	0.0	-0.0	-191.6	-191.6

Point Source, ISO 9613, Name: "Em_Inv1", ID: "Em_Inv1"																			
Nr.	X	Y	Z	Refl.	Freq.	LxT	LxN	K0	Dc	Adiv	Aatm	Agr	Afol	Ahous	Abar	Cmet	RL	LrT	LrN
	(m)	(m)	(m)		(Hz)	dB(A)	dB(A)	(dB)	(dB)	(dB)	(dB)	(dB)	(dB)	(dB)	(dB)	(dB)	(dB)	dB(A)	dB(A)
1	500641.43	5441565.63	272.60	0	63	68.1	-88.0	0.0	0.0	60.2	0.0	-3.8	0.0	0.0	0.0	0.0	-0.0	11.7	-88.0
2	500641.43	5441565.63	272.60	0	125	78.9	-88.0	0.0	0.0	60.2	0.1	2.5	0.0	0.0	0.0	0.0	-0.0	16.1	-88.0
3	500641.43	5441565.63	272.60	0	250	85.5	-88.0	0.0	0.0	60.2	0.3	3.1	0.0	0.0	0.0	0.0	-0.0	21.9	-88.0
4	500641.43	5441565.63	272.60	0	500	87.3	-88.0	0.0	0.0	60.2	0.6	-0.7	0.0	0.0	0.0	0.0	-0.0	27.3	-88.0
5	500641.43	5441565.63	272.60	0	1000	83.7	-88.0	0.0	0.0	60.2	1.1	-1.1	0.0	0.0	0.0	0.0	-0.0	23.6	-88.0
6	500641.43	5441565.63	272.60	0	2000	79.1	-88.0	0.0	0.0	60.2	2.8	-1.1	0.0	0.0	0.0	0.0	-0.0	17.3	-88.0
7	500641.43	5441565.63	272.60	0	4000	70.0	-88.0	0.0	0.0	60.2	9.4	-1.1	0.0	0.0	0.0	0.0	-0.0	1.5	-88.0
8	500641.43	5441565.63	272.60	0	8000	77.7	-88.0	0.0	0.0	60.2	33.6	-1.1	0.0	0.0	0.0	0.0	-0.0	-15.0	-88.0

Point Source, ISO 9613, Name: "Em_Inv2", ID: "Em_Inv2"																			
Nr.	X	Y	Z	Refl.	Freq.	LxT	LxN	K0	Dc	Adiv	Aatm	Agr	Afol	Ahous	Abar	Cmet	RL	LrT	LrN
	(m)	(m)	(m)		(Hz)	dB(A)	dB(A)	(dB)	(dB)	(dB)	(dB)	(dB)	(dB)	(dB)	(dB)	(dB)	(dB)	dB(A)	dB(A)
1	500641.43	5441776.83	272.60	0	63	68.1	-88.0	0.0	0.0	64.9	0.1	-4.7	0.0	0.0	0.0	0.0	-0.0	7.9	-88.0
2	500641.43	5441776.83	272.60	0	125	78.9	-88.0	0.0	0.0	64.9	0.2	3.1	0.0	0.0	0.0	0.0	-0.0	10.8	-88.0
3	500641.43	5441776.83	272.60	0	250	85.5	-88.0	0.0	0.0	64.9	0.5	2.8	0.0	0.0	0.0	0.0	-0.0	17.3	-88.0

Point Source, ISO 9613, Name: "Em_Inv2", ID: "Em_Inv2"																			
Nr.	X	Y	Z	Refl.	Freq.	LxT	LxN	K0	Dc	Adiv	Aatm	Agr	Afol	Ahous	Abar	Cmet	RL	LrT	LrN
	(m)	(m)	(m)		(Hz)	dB(A)	dB(A)	(dB)	(dB)	(dB)	(dB)	(dB)	(dB)	(dB)	(dB)	(dB)	(dB)	dB(A)	dB(A)
4	500641.43	5441776.83	272.60	0	500	87.3	-88.0	0.0	0.0	64.9	1.0	-1.0	0.0	0.0	0.0	0.0	-0.0	22.4	-88.0
5	500641.43	5441776.83	272.60	0	1000	83.7	-88.0	0.0	0.0	64.9	1.8	-1.4	0.0	0.0	0.0	0.0	-0.0	18.4	-88.0
6	500641.43	5441776.83	272.60	0	2000	79.1	-88.0	0.0	0.0	64.9	4.8	-1.4	0.0	0.0	0.0	0.0	-0.0	10.9	-88.0
7	500641.43	5441776.83	272.60	0	4000	70.0	-88.0	0.0	0.0	64.9	16.2	-1.4	0.0	0.0	0.0	0.0	-0.0	-9.6	-88.0
8	500641.43	5441776.83	272.60	0	8000	77.7	-88.0	0.0	0.0	64.9	57.7	-1.4	0.0	0.0	0.0	0.0	-0.0	-43.4	-88.0

Point Source, ISO 9613, Name: "Em_Inv3", ID: "Em_Inv3"																			
Nr.	X	Y	Z	Refl.	Freq.	LxT	LxN	K0	Dc	Adiv	Aatm	Agr	Afol	Ahous	Abar	Cmet	RL	LrT	LrN
	(m)	(m)	(m)		(Hz)	dB(A)	dB(A)	(dB)	(dB)	(dB)	(dB)	(dB)	(dB)	(dB)	(dB)	(dB)	(dB)	dB(A)	dB(A)
1	500313.43	5441776.83	272.60	0	63	68.1	-88.0	0.0	0.0	65.7	0.1	-4.8	0.0	0.0	0.0	0.0	-0.0	7.1	-88.0
2	500313.43	5441776.83	272.60	0	125	78.9	-88.0	0.0	0.0	65.7	0.2	3.2	0.0	0.0	0.0	0.0	-0.0	9.7	-88.0
3	500313.43	5441776.83	272.60	0	250	85.5	-88.0	0.0	0.0	65.7	0.6	2.8	0.0	0.0	0.0	0.0	-0.0	16.4	-88.0
4	500313.43	5441776.83	272.60	0	500	87.3	-88.0	0.0	0.0	65.7	1.1	-1.0	0.0	0.0	0.0	0.0	-0.0	21.6	-88.0
5	500313.43	5441776.83	272.60	0	1000	83.7	-88.0	0.0	0.0	65.7	2.0	-1.4	0.0	0.0	0.0	0.0	-0.0	17.4	-88.0
6	500313.43	5441776.83	272.60	0	2000	79.1	-88.0	0.0	0.0	65.7	5.3	-1.5	0.0	0.0	0.0	0.0	-0.0	9.6	-88.0
7	500313.43	5441776.83	272.60	0	4000	70.0	-88.0	0.0	0.0	65.7	17.8	-1.5	0.0	0.0	0.0	0.0	-0.0	-12.1	-88.0
8	500313.43	5441776.83	272.60	0	8000	77.7	-88.0	0.0	0.0	65.7	63.6	-1.5	0.0	0.0	0.0	0.0	-0.0	-50.1	-88.0

Point Source, ISO 9613, Name: "Em_Inv4", ID: "Em_Inv4"																			
Nr.	X	Y	Z	Refl.	Freq.	LxT	LxN	K0	Dc	Adiv	Aatm	Agr	Afol	Ahous	Abar	Cmet	RL	LrT	LrN
	(m)	(m)	(m)		(Hz)	dB(A)	dB(A)	(dB)	(dB)	(dB)	(dB)	(dB)	(dB)	(dB)	(dB)	(dB)	(dB)	dB(A)	dB(A)
1	500641.43	5441970.43	272.60	0	63	68.1	-88.0	0.0	0.0	67.7	0.1	-5.1	0.0	0.0	0.0	0.0	-0.0	5.4	-88.0
2	500641.43	5441970.43	272.60	0	125	78.9	-88.0	0.0	0.0	67.7	0.3	3.6	0.0	0.0	0.0	0.0	-0.0	7.3	-88.0
3	500641.43	5441970.43	272.60	0	250	85.5	-88.0	0.0	0.0	67.7	0.7	2.7	0.0	0.0	0.0	0.0	-0.0	14.3	-88.0
4	500641.43	5441970.43	272.60	0	500	87.3	-88.0	0.0	0.0	67.7	1.3	-1.1	0.0	0.0	0.0	0.0	-0.0	19.4	-88.0
5	500641.43	5441970.43	272.60	0	1000	83.7	-88.0	0.0	0.0	67.7	2.5	-1.5	0.0	0.0	0.0	0.0	-0.0	15.0	-88.0
6	500641.43	5441970.43	272.60	0	2000	79.1	-88.0	0.0	0.0	67.7	6.6	-1.5	0.0	0.0	0.0	0.0	-0.0	6.3	-88.0
7	500641.43	5441970.43	272.60	0	4000	70.0	-88.0	0.0	0.0	67.7	22.4	-1.5	0.0	0.0	0.0	0.0	-0.0	-18.7	-88.0
8	500641.43	5441970.43	272.60	0	8000	77.7	-88.0	0.0	0.0	67.7	80.1	-1.5	0.0	0.0	0.0	0.0	-0.0	-68.6	-88.0

Point Source, ISO 9613, Name: "Em_Inv5", ID: "Em_Inv5"																			
Nr.	X	Y	Z	Refl.	Freq.	LxT	LxN	K0	Dc	Adiv	Aatm	Agr	Afol	Ahous	Abar	Cmet	RL	LrT	LrN
	(m)	(m)	(m)		(Hz)	dB(A)	dB(A)	(dB)	(dB)	(dB)	(dB)	(dB)	(dB)	(dB)	(dB)	(dB)	(dB)	dB(A)	dB(A)
1	500313.43	5441970.43	272.60	0	63	68.1	-88.0	0.0	0.0	68.2	0.1	-5.1	0.0	0.0	0.0	0.0	-0.0	5.0	-88.0
2	500313.43	5441970.43	272.60	0	125	78.9	-88.0	0.0	0.0	68.2	0.3	3.7	0.0	0.0	0.0	0.0	-0.0	6.7	-88.0
3	500313.43	5441970.43	272.60	0	250	85.5	-88.0	0.0	0.0	68.2	0.8	2.7	0.0	0.0	0.0	0.0	-0.0	13.9	-88.0
4	500313.43	5441970.43	272.60	0	500	87.3	-88.0	0.0	0.0	68.2	1.4	-1.1	0.0	0.0	0.0	0.0	-0.0	18.8	-88.0
5	500313.43	5441970.43	272.60	0	1000	83.7	-88.0	0.0	0.0	68.2	2.6	-1.5	0.0	0.0	0.0	0.0	-0.0	14.4	-88.0
6	500313.43	5441970.43	272.60	0	2000	79.1	-88.0	0.0	0.0	68.2	7.0	-1.5	0.0	0.0	0.0	0.0	-0.0	5.5	-88.0
7	500313.43	5441970.43	272.60	0	4000	70.0	-88.0	0.0	0.0	68.2	23.7	-1.5	0.0	0.0	0.0	0.0	-0.0	-20.3	-88.0
8	500313.43	5441970.43	272.60	0	8000	77.7	-88.0	0.0	0.0	68.2	84.4	-1.5	0.0	0.0	0.0	0.0	-0.0	-73.3	-88.0

Point Source, ISO 9613, Name: "Em_Inv6", ID: "Em_Inv6"																			
Nr.	X	Y	Z	Refl.	Freq.	LxT	LxN	K0	Dc	Adiv	Aatm	Agr	Afol	Ahous	Abar	Cmet	RL	LrT	LrN
	(m)	(m)	(m)		(Hz)	dB(A)	dB(A)	(dB)	(dB)	(dB)	(dB)	(dB)	(dB)	(dB)	(dB)	(dB)	(dB)	dB(A)	dB(A)
1	500313.43	5442164.03	272.60	0	63	68.1	-88.0	0.0	0.0	70.1	0.1	-5.3	0.0	0.0	0.0	0.0	-0.0	3.1	-88.0
2	500313.43	5442164.03	272.60	0	125	78.9	-88.0	0.0	0.0	70.1	0.4	4.0	0.0	0.0	0.0	0.0	-0.0	4.3	-88.0
3	500313.43	5442164.03	272.60	0	250	85.5	-88.0	0.0	0.0	70.1	1.0	2.7	0.0	0.0	0.0	0.0	-0.0	11.7	-88.0
4	500313.43	5442164.03	272.60	0	500	87.3	-88.0	0.0	0.0	70.1	1.8	-1.2	0.0	0.0	0.0	0.0	-0.0	16.6	-88.0
5	500313.43	5442164.03	272.60	0	1000	83.7	-88.0	0.0	0.0	70.1	3.3	-1.6	0.0	0.0	0.0	0.0	-0.0	11.8	-88.0
6	500313.43	5442164.03	272.60	0	2000	79.1	-88.0	0.0	0.0	70.1	8.8	-1.6	0.0	0.0	0.0	0.0	-0.0	1.8	-88.0
7	500313.43	5442164.03	272.60	0	4000	70.0	-88.0	0.0	0.0	70.1	29.7	-1.6	0.0	0.0	0.0	0.0	-0.0	-28.3	-88.0
8	500313.43	5442164.03	272.60	0	8000	77.7	-88.0	0.0	0.0	70.1	106.0	-1.6	0.0	0.0	0.0	0.0	-0.0	-96.8	-88.0

Point Source, ISO 9613, Name: "Em_Inv7", ID: "Em_Inv7"																			
Nr.	X	Y	Z	Refl.	Freq.	LxT	LxN	K0	Dc	Adiv	Aatm	Agr	Afol	Ahous	Abar	Cmet	RL	LrT	LrN
	(m)	(m)	(m)		(Hz)	dB(A)	dB(A)	(dB)	(dB)	(dB)	(dB)	(dB)	(dB)	(dB)	(dB)	(dB)	(dB)	dB(A)	dB(A)
1	500641.43	5442164.03	268.61	0	63	68.1	-88.0	0.0	0.0	69.9	0.1	-5.3	0.0	0.0	4.8	0.0	-0.0	-1.4	-88.0
2	500641.43	5442164.03	268.61	0	125	78.9	-88.0	0.0	0.0	69.9	0.4	4.0	0.0	0.0	0.8	0.0	-0.0	3.9	-88.0
3	500641.43	5442164.03	268.61	0	250	85.5	-88.0	0.0	0.0	69.9	0.9	2.7	0.0	0.0	2.1	0.0	-0.0	10.0	-88.0
4	500641.43	5442164.03	268.61	0	500	87.3	-88.0	0.0	0.0	69.9	1.7	-1.1	0.0	0.0	4.8	0.0	-0.0	12.1	-88.0
5	500641.43	5442164.03	268.61	0	1000	83.7	-88.0	0.0	0.0	69.9	3.2	-1.6	0.0	0.0	4.8	0.0	-0.0	7.4	-88.0
6	500641.43	5442164.03	268.61	0	2000	79.1	-88.0	0.0	0.0	69.9	8.5	-1.6	0.0	0.0	4.8	0.0	-0.0	-2.4	-88.0

Point Source, ISO 9613, Name: "Em_Inv7", ID: "Em_Inv7"																			
Nr.	X	Y	Z	Refl.	Freq.	LxT	LxN	K0	Dc	Adiv	Aatm	Agr	Afol	Ahous	Abar	Cmet	RL	LrT	LrN
	(m)	(m)	(m)		(Hz)	dB(A)	dB(A)	(dB)	(dB)	(dB)	(dB)	(dB)	(dB)	(dB)	(dB)	(dB)	(dB)	dB(A)	dB(A)
7	500641.43	5442164.03	268.61	0	4000	70.0	-88.0	0.0	0.0	69.9	28.8	-1.6	0.0	0.0	4.8	0.0	-0.0	-31.8	-88.0
8	500641.43	5442164.03	268.61	0	8000	77.7	-88.0	0.0	0.0	69.9	102.6	-1.6	0.0	0.0	4.8	0.0	-0.0	-97.9	-88.0

Point Source, ISO 9613, Name: "Em_Trans1", ID: "Em_Trans1"																			
Nr.	X	Y	Z	Refl.	Freq.	LxT	LxN	K0	Dc	Adiv	Aatm	Agr	Afol	Ahous	Abar	Cmet	RL	LrT	LrN
	(m)	(m)	(m)		(Hz)	dB(A)	dB(A)	(dB)	(dB)	(dB)	(dB)	(dB)	(dB)	(dB)	(dB)	(dB)	(dB)	dB(A)	dB(A)
1	500646.93	5441565.13	272.58	0	32	37.3	37.3	0.0	0.0	60.2	0.0	-3.8	0.0	0.0	0.0	0.0	-0.0	-19.1	-19.1
2	500646.93	5441565.13	272.58	0	63	56.5	56.5	0.0	0.0	60.2	0.0	-3.8	0.0	0.0	0.0	0.0	-0.0	0.0	0.0
3	500646.93	5441565.13	272.58	0	125	68.6	68.6	0.0	0.0	60.2	0.1	2.5	0.0	0.0	0.0	0.0	-0.0	5.7	5.7
4	500646.93	5441565.13	272.58	0	250	71.1	71.1	0.0	0.0	60.2	0.3	3.1	0.0	0.0	0.0	0.0	-0.0	7.5	7.5
5	500646.93	5441565.13	272.58	0	500	76.5	76.5	0.0	0.0	60.2	0.6	-0.7	0.0	0.0	0.0	0.0	-0.0	16.4	16.4
6	500646.93	5441565.13	272.58	0	1000	73.7	73.7	0.0	0.0	60.2	1.1	-1.1	0.0	0.0	0.0	0.0	-0.0	13.6	13.6
7	500646.93	5441565.13	272.58	0	2000	69.9	69.9	0.0	0.0	60.2	2.8	-1.1	0.0	0.0	0.0	0.0	-0.0	8.0	8.0
8	500646.93	5441565.13	272.58	0	4000	64.7	64.7	0.0	0.0	60.2	9.5	-1.1	0.0	0.0	0.0	0.0	-0.0	-3.8	-3.8
9	500646.93	5441565.13	272.58	0	8000	55.6	55.6	0.0	0.0	60.2	33.8	-1.1	0.0	0.0	0.0	0.0	-0.0	-37.3	-37.3

Point Source, ISO 9613, Name: "Em_Trans2", ID: "Em_Trans2"																			
Nr.	X	Y	Z	Refl.	Freq.	LxT	LxN	K0	Dc	Adiv	Aatm	Agr	Afol	Ahous	Abar	Cmet	RL	LrT	LrN
	(m)	(m)	(m)		(Hz)	dB(A)	dB(A)	(dB)	(dB)	(dB)	(dB)	(dB)	(dB)	(dB)	(dB)	(dB)	(dB)	dB(A)	dB(A)
1	500646.93	5441776.33	272.58	0	32	37.3	37.3	0.0	0.0	64.9	0.0	-4.7	0.0	0.0	0.0	0.0	-0.0	-22.9	-22.9
2	500646.93	5441776.33	272.58	0	63	56.5	56.5	0.0	0.0	64.9	0.1	-4.7	0.0	0.0	0.0	0.0	-0.0	-3.7	-3.7
3	500646.93	5441776.33	272.58	0	125	68.6	68.6	0.0	0.0	64.9	0.2	3.1	0.0	0.0	0.0	0.0	-0.0	0.5	0.5
4	500646.93	5441776.33	272.58	0	250	71.1	71.1	0.0	0.0	64.9	0.5	2.9	0.0	0.0	0.0	0.0	-0.0	2.8	2.8
5	500646.93	5441776.33	272.58	0	500	76.5	76.5	0.0	0.0	64.9	1.0	-1.0	0.0	0.0	0.0	0.0	-0.0	11.6	11.6
6	500646.93	5441776.33	272.58	0	1000	73.7	73.7	0.0	0.0	64.9	1.8	-1.4	0.0	0.0	0.0	0.0	-0.0	8.4	8.4
7	500646.93	5441776.33	272.58	0	2000	69.9	69.9	0.0	0.0	64.9	4.8	-1.4	0.0	0.0	0.0	0.0	-0.0	1.7	1.7
8	500646.93	5441776.33	272.58	0	4000	64.7	64.7	0.0	0.0	64.9	16.2	-1.4	0.0	0.0	0.0	0.0	-0.0	-15.0	-15.0
9	500646.93	5441776.33	272.58	0	8000	55.6	55.6	0.0	0.0	64.9	57.8	-1.4	0.0	0.0	0.0	0.0	-0.0	-65.6	-65.6

Point Source, ISO 9613, Name: "Em_Trans3", ID: "Em_Trans3"																			
Nr.	X	Y	Z	Refl.	Freq.	LxT	LxN	K0	Dc	Adiv	Aatm	Agr	Afol	Ahous	Abar	Cmet	RL	LrT	LrN
	(m)	(m)	(m)		(Hz)	dB(A)	dB(A)	(dB)	(dB)	(dB)	(dB)	(dB)	(dB)	(dB)	(dB)	(dB)	(dB)	dB(A)	dB(A)
1	500318.93	5441776.33	272.58	0	32	37.3	37.3	0.0	0.0	65.7	0.0	-4.8	0.0	0.0	0.0	0.0	-0.0	-23.6	-23.6
2	500318.93	5441776.33	272.58	0	63	56.5	56.5	0.0	0.0	65.7	0.1	-4.8	0.0	0.0	0.0	0.0	-0.0	-4.4	-4.4
3	500318.93	5441776.33	272.58	0	125	68.6	68.6	0.0	0.0	65.7	0.2	3.2	0.0	0.0	0.0	0.0	-0.0	-0.5	-0.5
4	500318.93	5441776.33	272.58	0	250	71.1	71.1	0.0	0.0	65.7	0.6	2.8	0.0	0.0	0.0	0.0	-0.0	2.0	2.0
5	500318.93	5441776.33	272.58	0	500	76.5	76.5	0.0	0.0	65.7	1.0	-1.0	0.0	0.0	0.0	0.0	-0.0	10.8	10.8
6	500318.93	5441776.33	272.58	0	1000	73.7	73.7	0.0	0.0	65.7	2.0	-1.4	0.0	0.0	0.0	0.0	-0.0	7.5	7.5
7	500318.93	5441776.33	272.58	0	2000	69.9	69.9	0.0	0.0	65.7	5.2	-1.5	0.0	0.0	0.0	0.0	-0.0	0.5	0.5
8	500318.93	5441776.33	272.58	0	4000	64.7	64.7	0.0	0.0	65.7	17.7	-1.5	0.0	0.0	0.0	0.0	-0.0	-17.2	-17.2
9	500318.93	5441776.33	272.58	0	8000	55.6	55.6	0.0	0.0	65.7	63.2	-1.5	0.0	0.0	0.0	0.0	-0.0	-71.8	-71.8

Point Source, ISO 9613, Name: "Em_Trans4", ID: "Em_Trans4"																			
Nr.	X	Y	Z	Refl.	Freq.	LxT	LxN	K0	Dc	Adiv	Aatm	Agr	Afol	Ahous	Abar	Cmet	RL	LrT	LrN
	(m)	(m)	(m)		(Hz)	dB(A)	dB(A)	(dB)	(dB)	(dB)	(dB)	(dB)	(dB)	(dB)	(dB)	(dB)	(dB)	dB(A)	dB(A)
1	500646.93	5441969.93	272.58	0	32	37.3	37.3	0.0	0.0	67.7	0.0	-5.1	0.0	0.0	0.0	0.0	-0.0	-25.4	-25.4
2	500646.93	5441969.93	272.58	0	63	56.5	56.5	0.0	0.0	67.7	0.1	-5.1	0.0	0.0	0.0	0.0	-0.0	-6.2	-6.2
3	500646.93	5441969.93	272.58	0	125	68.6	68.6	0.0	0.0	67.7	0.3	3.6	0.0	0.0	0.0	0.0	-0.0	-3.0	-3.0
4	500646.93	5441969.93	272.58	0	250	71.1	71.1	0.0	0.0	67.7	0.7	2.8	0.0	0.0	0.0	0.0	-0.0	-0.1	-0.1
5	500646.93	5441969.93	272.58	0	500	76.5	76.5	0.0	0.0	67.7	1.3	-1.1	0.0	0.0	0.0	0.0	-0.0	8.5	8.5
6	500646.93	5441969.93	272.58	0	1000	73.7	73.7	0.0	0.0	67.7	2.5	-1.5	0.0	0.0	0.0	0.0	-0.0	5.0	5.0
7	500646.93	5441969.93	272.58	0	2000	69.9	69.9	0.0	0.0	67.7	6.6	-1.5	0.0	0.0	0.0	0.0	-0.0	-2.9	-2.9
8	500646.93	5441969.93	272.58	0	4000	64.7	64.7	0.0	0.0	67.7	22.5	-1.5	0.0	0.0	0.0	0.0	-0.0	-23.9	-23.9
9	500646.93	5441969.93	272.58	0	8000	55.6	55.6	0.0	0.0	67.7	80.1	-1.5	0.0	0.0	0.0	0.0	-0.0	-90.7	-90.7

Point Source, ISO 9613, Name: "Em_Trans5", ID: "Em_Trans5"																			
Nr.	X	Y	Z	Refl.	Freq.	LxT	LxN	K0	Dc	Adiv	Aatm	Agr	Afol	Ahous	Abar	Cmet	RL	LrT	LrN
	(m)	(m)	(m)		(Hz)	dB(A)	dB(A)	(dB)	(dB)	(dB)	(dB)	(dB)	(dB)	(dB)	(dB)	(dB)	(dB)	dB(A)	dB(A)
1	500318.93	5441969.93	272.58	0	32	37.3	37.3	0.0	0.0	68.1	0.0	-5.1	0.0	0.0	0.0	0.0	-0.0	-25.8	-25.8
2	500318.93	5441969.93	272.58	0	63	56.5	56.5	0.0	0.0	68.1	0.1	-5.1	0.0	0.0	0.0	0.0	-0.0	-6.6	-6.6
3	500318.93	5441969.93	272.58	0	125	68.6	68.6	0.0	0.0	68.1	0.3	3.7	0.0	0.0	0.0	0.0	-0.0	-3.6	-3.6
4	500318.93	5441969.93	272.58	0	250	71.1	71.1	0.0	0.0	68.1	0.8	2.8	0.0	0.0	0.0	0.0	-0.0	-0.5	-0.5
5	500318.93	5441969.93	272.58	0	500	76.5	76.5	0.0	0.0	68.1	1.4	-1.1	0.0	0.0	0.0	0.0	-0.0	8.0	8.0

Point Source, ISO 9613, Name: "Em_Trans5", ID: "Em_Trans5"																			
Nr.	X	Y	Z	Refl.	Freq.	LxT	LxN	K0	Dc	Adiv	Aatm	Agr	Afol	Ahous	Abar	Cmet	RL	LrT	LrN
	(m)	(m)	(m)		(Hz)	dB(A)	dB(A)	(dB)	(dB)	(dB)	(dB)	(dB)	(dB)	(dB)	(dB)	(dB)	(dB)	dB(A)	dB(A)
6	500318.93	5441969.93	272.58	0	1000	73.7	73.7	0.0	0.0	68.1	2.6	-1.5	0.0	0.0	0.0	0.0	-0.0	4.5	4.5
7	500318.93	5441969.93	272.58	0	2000	69.9	69.9	0.0	0.0	68.1	7.0	-1.5	0.0	0.0	0.0	0.0	-0.0	-3.7	-3.7
8	500318.93	5441969.93	272.58	0	4000	64.7	64.7	0.0	0.0	68.1	23.6	-1.5	0.0	0.0	0.0	0.0	-0.0	-25.5	-25.5
9	500318.93	5441969.93	272.58	0	8000	55.6	55.6	0.0	0.0	68.1	84.1	-1.5	0.0	0.0	0.0	0.0	-0.0	-95.1	-95.1

Point Source, ISO 9613, Name: "Em_Trans6", ID: "Em_Trans6"																			
Nr.	X	Y	Z	Refl.	Freq.	LxT	LxN	K0	Dc	Adiv	Aatm	Agr	Afol	Ahous	Abar	Cmet	RL	LrT	LrN
	(m)	(m)	(m)		(Hz)	dB(A)	dB(A)	(dB)	(dB)	(dB)	(dB)	(dB)	(dB)	(dB)	(dB)	(dB)	(dB)	dB(A)	dB(A)
1	500318.93	5442163.53	272.58	0	32	37.3	37.3	0.0	0.0	70.1	0.0	-5.3	0.0	0.0	0.0	0.0	-0.0	-27.6	-27.6
2	500318.93	5442163.53	272.58	0	63	56.5	56.5	0.0	0.0	70.1	0.1	-5.3	0.0	0.0	0.0	0.0	-0.0	-8.5	-8.5
3	500318.93	5442163.53	272.58	0	125	68.6	68.6	0.0	0.0	70.1	0.4	4.0	0.0	0.0	0.0	0.0	-0.0	-5.9	-5.9
4	500318.93	5442163.53	272.58	0	250	71.1	71.1	0.0	0.0	70.1	0.9	2.7	0.0	0.0	0.0	0.0	-0.0	-2.7	-2.7
5	500318.93	5442163.53	272.58	0	500	76.5	76.5	0.0	0.0	70.1	1.7	-1.1	0.0	0.0	0.0	0.0	-0.0	5.8	5.8
6	500318.93	5442163.53	272.58	0	1000	73.7	73.7	0.0	0.0	70.1	3.3	-1.6	0.0	0.0	0.0	0.0	-0.0	1.8	1.8
7	500318.93	5442163.53	272.58	0	2000	69.9	69.9	0.0	0.0	70.1	8.7	-1.6	0.0	0.0	0.0	0.0	-0.0	-7.4	-7.4
8	500318.93	5442163.53	272.58	0	4000	64.7	64.7	0.0	0.0	70.1	29.7	-1.6	0.0	0.0	0.0	0.0	-0.0	-33.5	-33.5
9	500318.93	5442163.53	272.58	0	8000	55.6	55.6	0.0	0.0	70.1	105.8	-1.6	0.0	0.0	0.0	0.0	-0.0	-118.7	-118.7

Point Source, ISO 9613, Name: "Em_Trans7", ID: "Em_Trans7"																			
Nr.	X	Y	Z	Refl.	Freq.	LxT	LxN	K0	Dc	Adiv	Aatm	Agr	Afol	Ahous	Abar	Cmet	RL	LrT	LrN
	(m)	(m)	(m)		(Hz)	dB(A)	dB(A)	(dB)	(dB)	(dB)	(dB)	(dB)	(dB)	(dB)	(dB)	(dB)	(dB)	dB(A)	dB(A)
1	500646.93	5442163.53	268.52	0	32	37.3	37.3	0.0	0.0	69.9	0.0	-5.3	0.0	0.0	4.8	0.0	-0.0	-32.1	-32.1
2	500646.93	5442163.53	268.52	0	63	56.5	56.5	0.0	0.0	69.9	0.1	-5.3	0.0	0.0	4.8	0.0	-0.0	-13.0	-13.0
3	500646.93	5442163.53	268.52	0	125	68.6	68.6	0.0	0.0	69.9	0.4	4.0	0.0	0.0	0.8	0.0	-0.0	-6.4	-6.4
4	500646.93	5442163.53	268.52	0	250	71.1	71.1	0.0	0.0	69.9	0.9	2.7	0.0	0.0	2.1	0.0	-0.0	-4.5	-4.5
5	500646.93	5442163.53	268.52	0	500	76.5	76.5	0.0	0.0	69.9	1.7	-1.1	0.0	0.0	4.8	0.0	-0.0	1.3	1.3
6	500646.93	5442163.53	268.52	0	1000	73.7	73.7	0.0	0.0	69.9	3.2	-1.6	0.0	0.0	4.8	0.0	-0.0	-2.6	-2.6
7	500646.93	5442163.53	268.52	0	2000	69.9	69.9	0.0	0.0	69.9	8.5	-1.6	0.0	0.0	4.8	0.0	-0.0	-11.6	-11.6
8	500646.93	5442163.53	268.52	0	4000	64.7	64.7	0.0	0.0	69.9	28.8	-1.6	0.0	0.0	4.8	0.0	-0.0	-37.1	-37.1
9	500646.93	5442163.53	268.52	0	8000	55.6	55.6	0.0	0.0	69.9	102.6	-1.6	0.0	0.0	4.8	0.0	-0.0	-120.0	-120.0

Point Source, ISO 9613, Name: "MM_Sub115", ID: "MM_Sub115"																			
Nr.	X	Y	Z	Refl.	Freq.	LxT	LxN	K0	Dc	Adiv	Aatm	Agr	Afol	Ahous	Abar	Cmet	RL	LrT	LrN
	(m)	(m)	(m)		(Hz)	dB(A)	dB(A)	(dB)	(dB)	(dB)	(dB)	(dB)	(dB)	(dB)	(dB)	(dB)	(dB)	dB(A)	dB(A)
1	500891.71	5443362.12	271.30	0	32	52.3	52.3	0.0	0.0	77.4	0.1	-5.6	0.0	0.0	0.0	0.0	-0.0	-19.6	-19.6
2	500891.71	5443362.12	271.30	0	63	71.5	71.5	0.0	0.0	77.4	0.3	-5.6	0.0	0.0	0.0	0.0	-0.0	-0.5	-0.5
3	500891.71	5443362.12	271.30	0	125	83.6	83.6	0.0	0.0	77.4	0.9	3.9	0.0	0.0	0.0	0.0	-0.0	1.4	1.4
4	500891.71	5443362.12	271.30	0	250	86.1	86.1	0.0	0.0	77.4	2.2	1.2	0.0	0.0	0.0	0.0	-0.0	5.3	5.3
5	500891.71	5443362.12	271.30	0	500	91.5	91.5	0.0	0.0	77.4	4.0	-1.7	0.0	0.0	0.0	0.0	-0.0	11.7	11.7
6	500891.71	5443362.12	271.30	0	1000	88.7	88.7	0.0	0.0	77.4	7.7	-1.7	0.0	0.0	0.0	0.0	-0.0	5.3	5.3
7	500891.71	5443362.12	271.30	0	2000	84.9	84.9	0.0	0.0	77.4	20.3	-1.7	0.0	0.0	0.0	0.0	-0.0	-11.1	-11.1
8	500891.71	5443362.12	271.30	0	4000	79.7	79.7	0.0	0.0	77.4	68.8	-1.7	0.0	0.0	0.0	0.0	-0.0	-64.8	-64.8
9	500891.71	5443362.12	271.30	0	8000	70.6	70.6	0.0	0.0	77.4	245.3	-1.7	0.0	0.0	0.0	0.0	-0.0	-250.4	-250.4

Point Source, ISO 9613, Name: "MM_Switch", ID: "MM_Switch"																			
Nr.	X	Y	Z	Refl.	Freq.	LxT	LxN	K0	Dc	Adiv	Aatm	Agr	Afol	Ahous	Abar	Cmet	RL	LrT	LrN
	(m)	(m)	(m)		(Hz)	dB(A)	dB(A)	(dB)	(dB)	(dB)	(dB)	(dB)	(dB)	(dB)	(dB)	(dB)	(dB)	dB(A)	dB(A)
1	501234.82	5443294.71	264.15	0	32	5.0	5.0	0.0	0.0	77.5	0.1	-5.7	0.0	0.0	4.8	0.0	-0.0	-71.7	-71.7
2	501234.82	5443294.71	264.15	0	63	5.0	5.0	0.0	0.0	77.5	0.3	-5.7	0.0	0.0	4.8	0.0	-0.0	-71.9	-71.9
3	501234.82	5443294.71	264.15	0	125	5.0	5.0	0.0	0.0	77.5	0.9	3.9	0.0	0.0	0.9	0.0	-0.0	-78.1	-78.1
4	501234.82	5443294.71	264.15	0	250	5.0	5.0	0.0	0.0	77.5	2.2	1.3	0.0	0.0	3.5	0.0	-0.0	-79.5	-79.5
5	501234.82	5443294.71	264.15	0	500	5.0	5.0	0.0	0.0	77.5	4.1	-1.7	0.0	0.0	4.8	0.0	-0.0	-79.7	-79.7
6	501234.82	5443294.71	264.15	0	1000	5.0	5.0	0.0	0.0	77.5	7.7	-1.7	0.0	0.0	4.8	0.0	-0.0	-83.3	-83.3
7	501234.82	5443294.71	264.15	0	2000	5.0	5.0	0.0	0.0	77.5	20.4	-1.7	0.0	0.0	4.8	0.0	-0.0	-96.0	-96.0
8	501234.82	5443294.71	264.15	0	4000	5.0	5.0	0.0	0.0	77.5	69.3	-1.7	0.0	0.0	4.8	0.0	-0.0	-144.9	-144.9
9	501234.82	5443294.71	264.15	0	8000	5.0	5.0	0.0	0.0	77.5	247.3	-1.7	0.0	0.0	4.8	0.0	-0.0	-322.9	-322.9

Point Source, ISO 9613, Name: "MM_Inv1", ID: "MM_Inv1"																			
Nr.	X	Y	Z	Refl.	Freq.	LxT	LxN	K0	Dc	Adiv	Aatm	Agr	Afol	Ahous	Abar	Cmet	RL	LrT	LrN
	(m)	(m)	(m)		(Hz)	dB(A)	dB(A)	(dB)	(dB)	(dB)	(dB)	(dB)	(dB)	(dB)	(dB)	(dB)	(dB)	dB(A)	dB(A)
1	501197.64	5443526.26	264.68	0	63	68.1	-88.0	0.0	0.0	78.3	0.3	-5.7	0.0	0.0	4.8	0.0	-0.0	-9.6	-88.0
2	501197.64	5443526.26	264.68	0	125	78.9	-88.0	0.0	0.0	78.3	1.0	4.2	0.0	0.0	0.6	0.0	-0.0	-5.2	-88.0
3	501197.64	5443526.26	264.68	0	250	85.5	-88.0	0.0	0.0	78.3	2.4	2.5	0.0	0.0	2.2	0.0	-0.0	-0.0	-88.0

Point Source, ISO 9613, Name: "MM_Inv1", ID: "MM_Inv1"																			
Nr.	X	Y	Z	Refl.	Freq.	LxT	LxN	K0	Dc	Adiv	Aatm	Agr	Afol	Ahous	Abar	Cmet	RL	LrT	LrN
	(m)	(m)	(m)		(Hz)	dB(A)	dB(A)	(dB)	(dB)	(dB)	(dB)	(dB)	(dB)	(dB)	(dB)	(dB)	(dB)	dB(A)	dB(A)
4	501197.64	5443526.26	264.68	0	500	87.3	-88.0	0.0	0.0	78.3	4.5	-1.3	0.0	0.0	4.8	0.0	-0.0	1.0	-88.0
5	501197.64	5443526.26	264.68	0	1000	83.7	-88.0	0.0	0.0	78.3	8.5	-1.7	0.0	0.0	4.8	0.0	-0.0	-6.2	-88.0
6	501197.64	5443526.26	264.68	0	2000	79.1	-88.0	0.0	0.0	78.3	22.5	-1.7	0.0	0.0	4.8	0.0	-0.0	-24.8	-88.0
7	501197.64	5443526.26	264.68	0	4000	70.0	-88.0	0.0	0.0	78.3	76.2	-1.7	0.0	0.0	4.8	0.0	-0.0	-87.6	-88.0
8	501197.64	5443526.26	264.68	0	8000	77.7	-88.0	0.0	0.0	78.3	271.8	-1.7	0.0	0.0	4.8	0.0	-0.0	-275.5	-88.0

Point Source, ISO 9613, Name: "MM_Inv2", ID: "MM_Inv2"																			
Nr.	X	Y	Z	Refl.	Freq.	LxT	LxN	K0	Dc	Adiv	Aatm	Agr	Afol	Ahous	Abar	Cmet	RL	LrT	LrN
	(m)	(m)	(m)		(Hz)	dB(A)	dB(A)	(dB)	(dB)	(dB)	(dB)	(dB)	(dB)	(dB)	(dB)	(dB)	(dB)	dB(A)	dB(A)
1	501247.04	5443116.97	262.69	0	63	68.1	-88.0	0.0	0.0	76.8	0.2	-5.7	0.0	0.0	4.8	0.0	-0.0	-8.1	-88.0
2	501247.04	5443116.97	262.69	0	125	78.9	-88.0	0.0	0.0	76.8	0.8	4.2	0.0	0.0	0.6	0.0	-0.0	-3.5	-88.0
3	501247.04	5443116.97	262.69	0	250	85.5	-88.0	0.0	0.0	76.8	2.0	2.5	0.0	0.0	2.2	0.0	-0.0	1.9	-88.0
4	501247.04	5443116.97	262.69	0	500	87.3	-88.0	0.0	0.0	76.8	3.8	-1.3	0.0	0.0	4.8	0.0	-0.0	3.2	-88.0
5	501247.04	5443116.97	262.69	0	1000	83.7	-88.0	0.0	0.0	76.8	7.1	-1.7	0.0	0.0	4.8	0.0	-0.0	-3.3	-88.0
6	501247.04	5443116.97	262.69	0	2000	79.1	-88.0	0.0	0.0	76.8	18.9	-1.7	0.0	0.0	4.8	0.0	-0.0	-19.7	-88.0
7	501247.04	5443116.97	262.69	0	4000	70.0	-88.0	0.0	0.0	76.8	64.0	-1.7	0.0	0.0	4.8	0.0	-0.0	-73.9	-88.0
8	501247.04	5443116.97	262.69	0	8000	77.7	-88.0	0.0	0.0	76.8	228.2	-1.7	0.0	0.0	4.8	0.0	-0.0	-230.4	-88.0

Point Source, ISO 9613, Name: "MM_Inv3", ID: "MM_Inv3"																			
Nr.	X	Y	Z	Refl.	Freq.	LxT	LxN	K0	Dc	Adiv	Aatm	Agr	Afol	Ahous	Abar	Cmet	RL	LrT	LrN
	(m)	(m)	(m)		(Hz)	dB(A)	dB(A)	(dB)	(dB)	(dB)	(dB)	(dB)	(dB)	(dB)	(dB)	(dB)	(dB)	dB(A)	dB(A)
1	501247.04	5442848.57	264.44	0	63	68.1	-88.0	0.0	0.0	75.6	0.2	-5.6	0.0	0.0	0.0	0.0	-0.0	-2.1	-88.0
2	501247.04	5442848.57	264.44	0	125	78.9	-88.0	0.0	0.0	75.6	0.7	4.2	0.0	0.0	0.0	0.0	-0.0	-1.7	-88.0
3	501247.04	5442848.57	264.44	0	250	85.5	-88.0	0.0	0.0	75.6	1.8	2.6	0.0	0.0	0.0	0.0	-0.0	5.5	-88.0
4	501247.04	5442848.57	264.44	0	500	87.3	-88.0	0.0	0.0	75.6	3.3	-1.3	0.0	0.0	0.0	0.0	-0.0	9.6	-88.0
5	501247.04	5442848.57	264.44	0	1000	83.7	-88.0	0.0	0.0	75.6	6.2	-1.7	0.0	0.0	0.0	0.0	-0.0	3.5	-88.0
6	501247.04	5442848.57	264.44	0	2000	79.1	-88.0	0.0	0.0	75.6	16.5	-1.7	0.0	0.0	0.0	0.0	-0.0	-11.3	-88.0
7	501247.04	5442848.57	264.44	0	4000	70.0	-88.0	0.0	0.0	75.6	55.8	-1.7	0.0	0.0	0.0	0.0	-0.0	-59.8	-88.0
8	501247.04	5442848.57	264.44	0	8000	77.7	-88.0	0.0	0.0	75.6	199.2	-1.7	0.0	0.0	0.0	0.0	-0.0	-195.4	-88.0

Point Source, ISO 9613, Name: "MM_Inv4", ID: "MM_Inv4"																			
Nr.	X	Y	Z	Refl.	Freq.	LxT	LxN	K0	Dc	Adiv	Aatm	Agr	Afol	Ahous	Abar	Cmet	RL	LrT	LrN
	(m)	(m)	(m)		(Hz)	dB(A)	dB(A)	(dB)	(dB)	(dB)	(dB)	(dB)	(dB)	(dB)	(dB)	(dB)	(dB)	dB(A)	dB(A)
1	501247.04	5442593.37	264.37	0	63	68.1	-88.0	0.0	0.0	74.4	0.2	-5.6	0.0	0.0	4.8	0.0	-0.0	-5.7	-88.0
2	501247.04	5442593.37	264.37	0	125	78.9	-88.0	0.0	0.0	74.4	0.6	4.2	0.0	0.0	0.5	0.0	-0.0	-0.9	-88.0
3	501247.04	5442593.37	264.37	0	250	85.5	-88.0	0.0	0.0	74.4	1.5	2.6	0.0	0.0	2.2	0.0	-0.0	4.8	-88.0
4	501247.04	5442593.37	264.37	0	500	87.3	-88.0	0.0	0.0	74.4	2.8	-1.2	0.0	0.0	4.8	0.0	-0.0	6.5	-88.0
5	501247.04	5442593.37	264.37	0	1000	83.7	-88.0	0.0	0.0	74.4	5.4	-1.7	0.0	0.0	4.8	0.0	-0.0	0.8	-88.0
6	501247.04	5442593.37	264.37	0	2000	79.1	-88.0	0.0	0.0	74.4	14.3	-1.7	0.0	0.0	4.8	0.0	-0.0	-12.6	-88.0
7	501247.04	5442593.37	264.37	0	4000	70.0	-88.0	0.0	0.0	74.4	48.3	-1.7	0.0	0.0	4.8	0.0	-0.0	-55.8	-88.0
8	501247.04	5442593.37	264.37	0	8000	77.7	-88.0	0.0	0.0	74.4	172.3	-1.7	0.0	0.0	4.8	0.0	-0.0	-172.1	-88.0

Point Source, ISO 9613, Name: "MM_Inv5", ID: "MM_Inv5"																			
Nr.	X	Y	Z	Refl.	Freq.	LxT	LxN	K0	Dc	Adiv	Aatm	Agr	Afol	Ahous	Abar	Cmet	RL	LrT	LrN
	(m)	(m)	(m)		(Hz)	dB(A)	dB(A)	(dB)	(dB)	(dB)	(dB)	(dB)	(dB)	(dB)	(dB)	(dB)	(dB)	dB(A)	dB(A)
1	500996.84	5442594.37	268.30	0	63	68.1	-88.0	0.0	0.0	73.8	0.2	-5.5	0.0	0.0	0.0	0.0	-0.0	-0.3	-88.0
2	500996.84	5442594.37	268.30	0	125	78.9	-88.0	0.0	0.0	73.8	0.6	4.2	0.0	0.0	0.0	0.0	-0.0	0.3	-88.0
3	500996.84	5442594.37	268.30	0	250	85.5	-88.0	0.0	0.0	73.8	1.4	2.6	0.0	0.0	0.0	0.0	-0.0	7.7	-88.0
4	500996.84	5442594.37	268.30	0	500	87.3	-88.0	0.0	0.0	73.8	2.6	-1.2	0.0	0.0	0.0	0.0	-0.0	12.1	-88.0
5	500996.84	5442594.37	268.30	0	1000	83.7	-88.0	0.0	0.0	73.8	5.0	-1.7	0.0	0.0	0.0	0.0	-0.0	6.5	-88.0
6	500996.84	5442594.37	268.30	0	2000	79.1	-88.0	0.0	0.0	73.8	13.3	-1.7	0.0	0.0	0.0	0.0	-0.0	-6.3	-88.0
7	500996.84	5442594.37	268.30	0	4000	70.0	-88.0	0.0	0.0	73.8	45.1	-1.7	0.0	0.0	0.0	0.0	-0.0	-47.2	-88.0
8	500996.84	5442594.37	268.30	0	8000	77.7	-88.0	0.0	0.0	73.8	160.8	-1.7	0.0	0.0	0.0	0.0	-0.0	-155.3	-88.0

Point Source, ISO 9613, Name: "MM_Inv6", ID: "MM_Inv6"																			
Nr.	X	Y	Z	Refl.	Freq.	LxT	LxN	K0	Dc	Adiv	Aatm	Agr	Afol	Ahous	Abar	Cmet	RL	LrT	LrN
	(m)	(m)	(m)		(Hz)	dB(A)	dB(A)	(dB)	(dB)	(dB)	(dB)	(dB)	(dB)	(dB)	(dB)	(dB)	(dB)	dB(A)	dB(A)
1	500996.84	5442849.57	272.18	0	63	68.1	-88.0	0.0	0.0	75.2	0.2	-5.6	0.0	0.0	0.0	0.0	-0.0	-1.7	-88.0
2	500996.84	5442849.57	272.18	0	125	78.9	-88.0	0.0	0.0	75.2	0.7	4.2	0.0	0.0	0.0	0.0	-0.0	-1.2	-88.0
3	500996.84	5442849.57	272.18	0	250	85.5	-88.0	0.0	0.0	75.2	1.7	2.6	0.0	0.0	0.0	0.0	-0.0	6.0	-88.0
4	500996.84	5442849.57	272.18	0	500	87.3	-88.0	0.0	0.0	75.2	3.1	-1.2	0.0	0.0	0.0	0.0	-0.0	10.2	-88.0
5	500996.84	5442849.57	272.18	0	1000	83.7	-88.0	0.0	0.0	75.2	5.9	-1.7	0.0	0.0	0.0	0.0	-0.0	4.3	-88.0
6	500996.84	5442849.57	272.18	0	2000	79.1	-88.0	0.0	0.0	75.2	15.7	-1.7	0.0	0.0	0.0	0.0	-0.0	-10.1	-88.0

Point Source, ISO 9613, Name: "MM_Inv6", ID: "MM_Inv6"																			
Nr.	X	Y	Z	Refl.	Freq.	LxT	LxN	K0	Dc	Adiv	Aatm	Agr	Afol	Ahous	Abar	Cmet	RL	LrT	LrN
	(m)	(m)	(m)		(Hz)	dB(A)	dB(A)	(dB)	(dB)	(dB)	(dB)	(dB)	(dB)	(dB)	(dB)	(dB)	(dB)	dB(A)	dB(A)
7	500996.84	5442849.57	272.18	0	4000	70.0	-88.0	0.0	0.0	75.2	53.1	-1.7	0.0	0.0	0.0	0.0	-0.0	-56.6	-88.0
8	500996.84	5442849.57	272.18	0	8000	77.7	-88.0	0.0	0.0	75.2	189.3	-1.7	0.0	0.0	0.0	0.0	-0.0	-185.2	-88.0

Point Source, ISO 9613, Name: "MM_Inv7", ID: "MM_Inv7"																			
Nr.	X	Y	Z	Refl.	Freq.	LxT	LxN	K0	Dc	Adiv	Aatm	Agr	Afol	Ahous	Abar	Cmet	RL	LrT	LrN
	(m)	(m)	(m)		(Hz)	dB(A)	dB(A)	(dB)	(dB)	(dB)	(dB)	(dB)	(dB)	(dB)	(dB)	(dB)	(dB)	dB(A)	dB(A)
1	501007.84	5443117.77	272.60	0	63	68.1	-88.0	0.0	0.0	76.5	0.2	-5.7	0.0	0.0	0.0	0.0	-0.0	-3.0	-88.0
2	501007.84	5443117.77	272.60	0	125	78.9	-88.0	0.0	0.0	76.5	0.8	4.2	0.0	0.0	0.0	0.0	-0.0	-2.6	-88.0
3	501007.84	5443117.77	272.60	0	250	85.5	-88.0	0.0	0.0	76.5	2.0	2.5	0.0	0.0	0.0	0.0	-0.0	4.5	-88.0
4	501007.84	5443117.77	272.60	0	500	87.3	-88.0	0.0	0.0	76.5	3.6	-1.3	0.0	0.0	0.0	0.0	-0.0	8.4	-88.0
5	501007.84	5443117.77	272.60	0	1000	83.7	-88.0	0.0	0.0	76.5	6.9	-1.7	0.0	0.0	0.0	0.0	-0.0	2.0	-88.0
6	501007.84	5443117.77	272.60	0	2000	79.1	-88.0	0.0	0.0	76.5	18.2	-1.7	0.0	0.0	0.0	0.0	-0.0	-13.9	-88.0
7	501007.84	5443117.77	272.60	0	4000	70.0	-88.0	0.0	0.0	76.5	61.7	-1.7	0.0	0.0	0.0	0.0	-0.0	-66.5	-88.0
8	501007.84	5443117.77	272.60	0	8000	77.7	-88.0	0.0	0.0	76.5	220.0	-1.7	0.0	0.0	0.0	0.0	-0.0	-217.1	-88.0

Point Source, ISO 9613, Name: "MM_Trans1", ID: "MM_Trans1"																			
Nr.	X	Y	Z	Refl.	Freq.	LxT	LxN	K0	Dc	Adiv	Aatm	Agr	Afol	Ahous	Abar	Cmet	RL	LrT	LrN
	(m)	(m)	(m)		(Hz)	dB(A)	dB(A)	(dB)	(dB)	(dB)	(dB)	(dB)	(dB)	(dB)	(dB)	(dB)	(dB)	dB(A)	dB(A)
1	501197.14	5443520.76	264.67	0	32	37.3	37.3	0.0	0.0	78.3	0.1	-5.7	0.0	0.0	4.8	0.0	-0.0	-40.1	-40.1
2	501197.14	5443520.76	264.67	0	63	56.5	56.5	0.0	0.0	78.3	0.3	-5.7	0.0	0.0	4.8	0.0	-0.0	-21.1	-21.1
3	501197.14	5443520.76	264.67	0	125	68.6	68.6	0.0	0.0	78.3	1.0	4.2	0.0	0.0	0.6	0.0	-0.0	-15.4	-15.4
4	501197.14	5443520.76	264.67	0	250	71.1	71.1	0.0	0.0	78.3	2.4	2.6	0.0	0.0	2.2	0.0	-0.0	-14.4	-14.4
5	501197.14	5443520.76	264.67	0	500	76.5	76.5	0.0	0.0	78.3	4.5	-1.3	0.0	0.0	4.8	0.0	-0.0	-9.8	-9.8
6	501197.14	5443520.76	264.67	0	1000	73.7	73.7	0.0	0.0	78.3	8.5	-1.7	0.0	0.0	4.8	0.0	-0.0	-16.2	-16.2
7	501197.14	5443520.76	264.67	0	2000	69.9	69.9	0.0	0.0	78.3	22.4	-1.7	0.0	0.0	4.8	0.0	-0.0	-33.9	-33.9
8	501197.14	5443520.76	264.67	0	4000	64.7	64.7	0.0	0.0	78.3	76.0	-1.7	0.0	0.0	4.8	0.0	-0.0	-92.7	-92.7
9	501197.14	5443520.76	264.67	0	8000	55.6	55.6	0.0	0.0	78.3	271.2	-1.7	0.0	0.0	4.8	0.0	-0.0	-297.0	-297.0

Point Source, ISO 9613, Name: "MM_Trans2", ID: "MM_Trans2"																			
Nr.	X	Y	Z	Refl.	Freq.	LxT	LxN	K0	Dc	Adiv	Aatm	Agr	Afol	Ahous	Abar	Cmet	RL	LrT	LrN
	(m)	(m)	(m)		(Hz)	dB(A)	dB(A)	(dB)	(dB)	(dB)	(dB)	(dB)	(dB)	(dB)	(dB)	(dB)	(dB)	dB(A)	dB(A)
1	501241.54	5443117.47	262.92	0	32	37.3	37.3	0.0	0.0	76.8	0.1	-5.7	0.0	0.0	4.8	0.0	-0.0	-38.7	-38.7
2	501241.54	5443117.47	262.92	0	63	56.5	56.5	0.0	0.0	76.8	0.2	-5.7	0.0	0.0	4.8	0.0	-0.0	-19.6	-19.6
3	501241.54	5443117.47	262.92	0	125	68.6	68.6	0.0	0.0	76.8	0.8	4.2	0.0	0.0	0.6	0.0	-0.0	-13.8	-13.8
4	501241.54	5443117.47	262.92	0	250	71.1	71.1	0.0	0.0	76.8	2.0	2.6	0.0	0.0	2.2	0.0	-0.0	-12.5	-12.5
5	501241.54	5443117.47	262.92	0	500	76.5	76.5	0.0	0.0	76.8	3.8	-1.2	0.0	0.0	4.8	0.0	-0.0	-7.6	-7.6
6	501241.54	5443117.47	262.92	0	1000	73.7	73.7	0.0	0.0	76.8	7.1	-1.7	0.0	0.0	4.8	0.0	-0.0	-13.3	-13.3
7	501241.54	5443117.47	262.92	0	2000	69.9	69.9	0.0	0.0	76.8	18.9	-1.7	0.0	0.0	4.8	0.0	-0.0	-28.8	-28.8
8	501241.54	5443117.47	262.92	0	4000	64.7	64.7	0.0	0.0	76.8	63.9	-1.7	0.0	0.0	4.8	0.0	-0.0	-79.1	-79.1
9	501241.54	5443117.47	262.92	0	8000	55.6	55.6	0.0	0.0	76.8	228.0	-1.7	0.0	0.0	4.8	0.0	-0.0	-252.3	-252.3

Point Source, ISO 9613, Name: "MM_Trans3", ID: "MM_Trans3"																			
Nr.	X	Y	Z	Refl.	Freq.	LxT	LxN	K0	Dc	Adiv	Aatm	Agr	Afol	Ahous	Abar	Cmet	RL	LrT	LrN
	(m)	(m)	(m)		(Hz)	dB(A)	dB(A)	(dB)	(dB)	(dB)	(dB)	(dB)	(dB)	(dB)	(dB)	(dB)	(dB)	dB(A)	dB(A)
1	501241.54	5442849.07	264.59	0	32	37.3	37.3	0.0	0.0	75.6	0.1	-5.6	0.0	0.0	0.0	0.0	-0.0	-32.8	-32.8
2	501241.54	5442849.07	264.59	0	63	56.5	56.5	0.0	0.0	75.6	0.2	-5.6	0.0	0.0	0.0	0.0	-0.0	-13.7	-13.7
3	501241.54	5442849.07	264.59	0	125	68.6	68.6	0.0	0.0	75.6	0.7	4.2	0.0	0.0	0.0	0.0	-0.0	-12.0	-12.0
4	501241.54	5442849.07	264.59	0	250	71.1	71.1	0.0	0.0	75.6	1.8	2.6	0.0	0.0	0.0	0.0	-0.0	-8.9	-8.9
5	501241.54	5442849.07	264.59	0	500	76.5	76.5	0.0	0.0	75.6	3.3	-1.2	0.0	0.0	0.0	0.0	-0.0	-1.2	-1.2
6	501241.54	5442849.07	264.59	0	1000	73.7	73.7	0.0	0.0	75.6	6.2	-1.7	0.0	0.0	0.0	0.0	-0.0	-6.5	-6.5
7	501241.54	5442849.07	264.59	0	2000	69.9	69.9	0.0	0.0	75.6	16.4	-1.7	0.0	0.0	0.0	0.0	-0.0	-20.5	-20.5
8	501241.54	5442849.07	264.59	0	4000	64.7	64.7	0.0	0.0	75.6	55.8	-1.7	0.0	0.0	0.0	0.0	-0.0	-65.0	-65.0
9	501241.54	5442849.07	264.59	0	8000	55.6	55.6	0.0	0.0	75.6	199.0	-1.7	0.0	0.0	0.0	0.0	-0.0	-217.3	-217.3

Point Source, ISO 9613, Name: "MM_Trans4", ID: "MM_Trans4"																			
Nr.	X	Y	Z	Refl.	Freq.	LxT	LxN	K0	Dc	Adiv	Aatm	Agr	Afol	Ahous	Abar	Cmet	RL	LrT	LrN
	(m)	(m)	(m)		(Hz)	dB(A)	dB(A)	(dB)	(dB)	(dB)	(dB)	(dB)	(dB)	(dB)	(dB)	(dB)	(dB)	dB(A)	dB(A)
1	501241.54	5442593.87	264.50	0	32	37.3	37.3	0.0	0.0	74.4	0.1	-5.6	0.0	0.0	4.8	0.0	-0.0	-36.3	-36.3
2	501241.54	5442593.87	264.50	0	63	56.5	56.5	0.0	0.0	74.4	0.2	-5.6	0.0	0.0	4.8	0.0	-0.0	-17.2	-17.2
3	501241.54	5442593.87	264.50	0	125	68.6	68.6	0.0	0.0	74.4	0.6	4.2	0.0	0.0	0.5	0.0	-0.0	-11.1	-11.1
4	501241.54	5442593.87	264.50	0	250	71.1	71.1	0.0	0.0	74.4	1.5	2.6	0.0	0.0	2.2	0.0	-0.0	-9.6	-9.6
5	501241.54	5442593.87	264.50	0	500	76.5	76.5	0.0	0.0	74.4	2.8	-1.2	0.0	0.0	4.8	0.0	-0.0	-4.3	-4.3
6	501241.54	5442593.87	264.50	0	1000	73.7	73.7	0.0	0.0	74.4	5.4	-1.7	0.0	0.0	4.8	0.0	-0.0	-9.2	-9.2

Point Source, ISO 9613, Name: "MM_Trans4", ID: "MM_Trans4"																			
Nr.	X	Y	Z	Refl.	Freq.	LxT	LxN	K0	Dc	Adiv	Aatm	Agr	Afol	Ahous	Abar	Cmet	RL	LrT	LrN
	(m)	(m)	(m)		(Hz)	dB(A)	dB(A)	(dB)	(dB)	(dB)	(dB)	(dB)	(dB)	(dB)	(dB)	(dB)	(dB)	dB(A)	dB(A)
7	501241.54	5442593.87	264.50	0	2000	69.9	69.9	0.0	0.0	74.4	14.2	-1.7	0.0	0.0	4.8	0.0	-0.0	-21.8	-21.8
8	501241.54	5442593.87	264.50	0	4000	64.7	64.7	0.0	0.0	74.4	48.2	-1.7	0.0	0.0	4.8	0.0	-0.0	-61.0	-61.0
9	501241.54	5442593.87	264.50	0	8000	55.6	55.6	0.0	0.0	74.4	172.1	-1.7	0.0	0.0	4.8	0.0	-0.0	-193.9	-193.9

Point Source, ISO 9613, Name: "MM_Trans5", ID: "MM_Trans5"																			
Nr.	X	Y	Z	Refl.	Freq.	LxT	LxN	K0	Dc	Adiv	Aatm	Agr	Afol	Ahous	Abar	Cmet	RL	LrT	LrN
	(m)	(m)	(m)		(Hz)	dB(A)	dB(A)	(dB)	(dB)	(dB)	(dB)	(dB)	(dB)	(dB)	(dB)	(dB)	(dB)	dB(A)	dB(A)
1	501002.34	5442593.87	268.25	0	32	37.3	37.3	0.0	0.0	73.8	0.0	-5.5	0.0	0.0	0.0	0.0	-0.0	-31.0	-31.0
2	501002.34	5442593.87	268.25	0	63	56.5	56.5	0.0	0.0	73.8	0.2	-5.5	0.0	0.0	0.0	0.0	-0.0	-11.9	-11.9
3	501002.34	5442593.87	268.25	0	125	68.6	68.6	0.0	0.0	73.8	0.6	4.2	0.0	0.0	0.0	0.0	-0.0	-10.0	-10.0
4	501002.34	5442593.87	268.25	0	250	71.1	71.1	0.0	0.0	73.8	1.4	2.6	0.0	0.0	0.0	0.0	-0.0	-6.7	-6.7
5	501002.34	5442593.87	268.25	0	500	76.5	76.5	0.0	0.0	73.8	2.7	-1.2	0.0	0.0	0.0	0.0	-0.0	1.3	1.3
6	501002.34	5442593.87	268.25	0	1000	73.7	73.7	0.0	0.0	73.8	5.0	-1.7	0.0	0.0	0.0	0.0	-0.0	-3.5	-3.5
7	501002.34	5442593.87	268.25	0	2000	69.9	69.9	0.0	0.0	73.8	13.3	-1.7	0.0	0.0	0.0	0.0	-0.0	-15.5	-15.5
8	501002.34	5442593.87	268.25	0	4000	64.7	64.7	0.0	0.0	73.8	45.1	-1.7	0.0	0.0	0.0	0.0	-0.0	-52.6	-52.6
9	501002.34	5442593.87	268.25	0	8000	55.6	55.6	0.0	0.0	73.8	161.0	-1.7	0.0	0.0	0.0	0.0	-0.0	-177.5	-177.5

Point Source, ISO 9613, Name: "MM_Trans6", ID: "MM_Trans6"																			
Nr.	X	Y	Z	Refl.	Freq.	LxT	LxN	K0	Dc	Adiv	Aatm	Agr	Afol	Ahous	Abar	Cmet	RL	LrT	LrN
	(m)	(m)	(m)		(Hz)	dB(A)	dB(A)	(dB)	(dB)	(dB)	(dB)	(dB)	(dB)	(dB)	(dB)	(dB)	(dB)	dB(A)	dB(A)
1	501002.34	5442849.07	271.99	0	32	37.3	37.3	0.0	0.0	75.2	0.1	-5.6	0.0	0.0	0.0	0.0	-0.0	-32.3	-32.3
2	501002.34	5442849.07	271.99	0	63	56.5	56.5	0.0	0.0	75.2	0.2	-5.6	0.0	0.0	0.0	0.0	-0.0	-13.3	-13.3
3	501002.34	5442849.07	271.99	0	125	68.6	68.6	0.0	0.0	75.2	0.7	4.2	0.0	0.0	0.0	0.0	-0.0	-11.5	-11.5
4	501002.34	5442849.07	271.99	0	250	71.1	71.1	0.0	0.0	75.2	1.7	2.6	0.0	0.0	0.0	0.0	-0.0	-8.4	-8.4
5	501002.34	5442849.07	271.99	0	500	76.5	76.5	0.0	0.0	75.2	3.1	-1.2	0.0	0.0	0.0	0.0	-0.0	-0.6	-0.6
6	501002.34	5442849.07	271.99	0	1000	73.7	73.7	0.0	0.0	75.2	5.9	-1.7	0.0	0.0	0.0	0.0	-0.0	-5.8	-5.8
7	501002.34	5442849.07	271.99	0	2000	69.9	69.9	0.0	0.0	75.2	15.7	-1.7	0.0	0.0	0.0	0.0	-0.0	-19.3	-19.3
8	501002.34	5442849.07	271.99	0	4000	64.7	64.7	0.0	0.0	75.2	53.1	-1.7	0.0	0.0	0.0	0.0	-0.0	-61.9	-61.9
9	501002.34	5442849.07	271.99	0	8000	55.6	55.6	0.0	0.0	75.2	189.5	-1.7	0.0	0.0	0.0	0.0	-0.0	-207.4	-207.4

Point Source, ISO 9613, Name: "MM_Trans7", ID: "MM_Trans7"																			
Nr.	X	Y	Z	Refl.	Freq.	LxT	LxN	K0	Dc	Adiv	Aatm	Agr	Afol	Ahous	Abar	Cmet	RL	LrT	LrN
	(m)	(m)	(m)		(Hz)	dB(A)	dB(A)	(dB)	(dB)	(dB)	(dB)	(dB)	(dB)	(dB)	(dB)	(dB)	(dB)	dB(A)	dB(A)
1	501002.34	5443118.27	272.58	0	32	37.3	37.3	0.0	0.0	76.5	0.1	-5.7	0.0	0.0	0.0	0.0	-0.0	-33.6	-33.6
2	501002.34	5443118.27	272.58	0	63	56.5	56.5	0.0	0.0	76.5	0.2	-5.7	0.0	0.0	0.0	0.0	-0.0	-14.6	-14.6
3	501002.34	5443118.27	272.58	0	125	68.6	68.6	0.0	0.0	76.5	0.8	4.2	0.0	0.0	0.0	0.0	-0.0	-12.9	-12.9
4	501002.34	5443118.27	272.58	0	250	71.1	71.1	0.0	0.0	76.5	2.0	2.6	0.0	0.0	0.0	0.0	-0.0	-9.9	-9.9
5	501002.34	5443118.27	272.58	0	500	76.5	76.5	0.0	0.0	76.5	3.6	-1.2	0.0	0.0	0.0	0.0	-0.0	-2.4	-2.4
6	501002.34	5443118.27	272.58	0	1000	73.7	73.7	0.0	0.0	76.5	6.9	-1.7	0.0	0.0	0.0	0.0	-0.0	-8.0	-8.0
7	501002.34	5443118.27	272.58	0	2000	69.9	69.9	0.0	0.0	76.5	18.2	-1.7	0.0	0.0	0.0	0.0	-0.0	-23.1	-23.1
8	501002.34	5443118.27	272.58	0	4000	64.7	64.7	0.0	0.0	76.5	61.6	-1.7	0.0	0.0	0.0	0.0	-0.0	-71.7	-71.7
9	501002.34	5443118.27	272.58	0	8000	55.6	55.6	0.0	0.0	76.5	219.9	-1.7	0.0	0.0	0.0	0.0	-0.0	-239.1	-239.1