

ENVIRONMENTAL NOISE IMPACT ASSESSMENT

McLEANS MOUNTAIN WIND FARM MANITOULIN ISLAND, ONTARIO

PREPARED FOR:

Northland Power Inc.
30 ST CLAIR AVE W,
Toronto, ON
M4V 3A1

PREPARED BY:

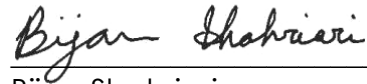

Bijan Shahriari

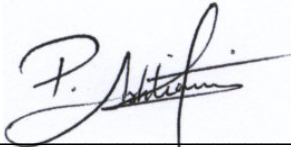

Payam Ashtiani, B.A.Sc., P.Eng

AERCOUSTICS ENGINEERING LIMITED
50 Ronson Drive, Suite 165
Toronto, Ontario
M9W 1B3

22 July 2009
Revised 14 September 2011

Executive Summary

The purpose of this environmental noise impact assessment, prepared for the Northland Power Inc (“NPI”) M1 Wind Project (the “Project”), is to fulfill NPI’s requirements under Ontario Regulation 116/01 of the *Environmental Assessment Act* and to provide the basis for the Certificate of Approval – Air [“C of A (Air)”] under Section 9 of the *Environmental Protection Act* (“EPA”). The objective of this assessment is to demonstrate, by means of technical assessment, that the noise impact from the operation of the Project will comply with the Ministry of the Environment’s (“MOE”) environmental noise guidelines for wind turbines.

Building upon the project specific guidelines, noise impact prediction modelling was undertaken. The noise impact from the Project’s wind turbine array and transformers and including neighbouring wind turbines operating at maximum rated power on the nearest points of reception was predicted using an acoustic model, ISO 9613, as required by the MOE.

The analysis shows that the noise impact from the Project does not exceed the most restrictive noise limits that apply for areas with acoustic designation of Class 3 (Rural) as defined by the MOE. Consequently, there is no need for the application of any additional mitigation measures and no further studies are contemplated for environmental noise in relation to the Project.

Table of Contents

1.0	INTRODUCTION	2
2.0	DISCUSSION OF ACOUSTIC TERMINOLOGY	3
3.0	DESCRIPTION OF WIND TURBINE SITE AND SURROUNDS.....	4
3.1	DESCRIPTION OF RECEPTORS	5
3.2	MOE ENVIRONMENTAL NOISE LIMITS	5
3.2.1	<i>Wind Turbine Installations in Class 1 & 2 Areas (Urban): Wind Speeds Below 8m/s</i>	<i>5</i>
3.2.2	<i>Wind Turbine Installations In Class 3 Areas (Rural): Wind Speeds Below 6m/s</i>	<i>5</i>
3.2.3	<i>Wind Turbine Installations In Class 1 & 2 and Class 3 Areas: Wind Speeds Above 8m/s and 6m/s Respectively.....</i>	<i>6</i>
4.0	DESCRIPTION OF SOURCES	7
4.1	M1 TRANSFORMER STATION.....	7
4.2	WIND TURBINE GENERATORS.....	8
4.2.1	<i>Potential Sources of Noise.....</i>	<i>8</i>
4.2.2	<i>M1 Wind Turbine Noise Emission Rating</i>	<i>9</i>
4.2.3	<i>Providence Bay Wind Farm.....</i>	<i>10</i>
5.0	NOISE ASSESSMENT RESULTS	11
5.1	TRANSFORMER STATION IMPACT ASSESSMENT	11
5.2	WIND TURBINE IMPACT ASSESSMENT.....	11
5.3	WIND TURBINE SUMMARY TABLES	12
6.0	CONCLUSION	13
	REFERENCES:.....	14

List of Tables

Table 1: MOE Sound Level Limits at Points of Reception for Wind Plants..... 6
Table 2: Sound Level Limits for Class 3 Areas..... 7
Table 3: Transformer Location..... 8
Table 4: GE 2.5-103, Sound Power Spectrums at wind speeds from 6m/s to 10m/s 9
Table 5: Wind Turbine Locations..... 10

List of Figures

- Figure 1: Key Plan
- Figure 2: Turbine and Transformer Layout
- Figure 3: Transformer Dimensions
- Figure 5: M1Noise Contours, 6m/s wind, 100% downwind

ATTACHMENT A

REPRINT OF: NOISE GUIDELINES FOR WIND FARMS, INTERPRETATION FOR APPLYING MOE NPC PUBLICATIONS TO WIND POWER GENERATION FACILITIES, ONTARIO MINISTRY OF ENVIRONMENT, OCTOBER 2008

ATTACHMENT B

GE 2.5-103 TURBINE DATA

ATTACHMENT C

SAMPLE CALCULATION FOR NIGHT TIME NOISE IMPACT ON R288

GLOSSARY

agl	above ground level
C of A (Air)	Certificate of Approval – Air
Northland	Northland Power Inc.
M1	Northland Power McLean’s Mountain Wind Farm
dBA	decibel A-weighted
ENIA	Environmental Noise Impact Assessment
EPA	<i>Environmental Protection Act</i>
IEC	International Electrotechnical Commission
ISO	International Organization for Standardization
kW	kilowatt
kV	kilovolt
LLA	Licence and Option to Lease Agreement
m	metre
m/s	metres per second
MOE	Ontario Ministry of the Environment
MW	Megawatt
PWL	Sound Power Level

1.0 INTRODUCTION

Northland Power Inc. (“NPI”) has retained Aercoustics Engineering Limited (“Aercoustics”) to prepare an environmental noise impact assessment (“ENIA”) of the proposed 72 megawatt (“MW”) M1 Manitoulin Island Wind Project (“Project”). The Project is situated near little current, in the Municipality of North-eastern Manitoulin and the Islands, Ontario.

The purpose of this ENIA is to fulfill NPI’s requirements under Ontario Regulation 116/01 of the *Environmental Assessment Act* and to provide the basis for the Certificate of Approval – Air [“C of A (Air)”] under Section 9 of the *Environmental Protection Act* (“EPA”). Consequently, in fulfilling these requirements, the objective of this assessment is to:

Predict the noise impacts from the Project at the nearest points of reception and to demonstrate, by means of technical assessment, that the noise impact from the operation of the Project will comply with the Ministry of the Environment’s (“MOE”) environmental noise guidelines for wind turbines.

The sound level limits and the noise assessment procedures are defined by the MOE in their October 2008 publication: “*Noise Guidelines for Wind Farms, Interpretation for Applying MOE NPC Publications to Wind Power Generation Facilities*” [17]. For continued reference, the MOE Interpretation (Attachment A) was prepared to assist proponents of wind turbine installations in determining what information should be submitted when applying for a C of A (Air), under the EPA.

The noise assessment was based on all of the recommended procedures outlined in the MOE’s “Noise Guidelines for Wind farms, October 2008” [17].

2.0 DISCUSSION OF ACOUSTIC TERMINOLOGY

In order to fully understand the analysis presented in this ENIA, a brief discussion of the technical terms utilized throughout the report is included below.

The noise data presented in this report has been given in terms of sound pressure level. Sound pressure levels are measured in decibels (“dB”). It is common practice to sum sound pressure levels over the entire audible spectrum to give an overall sound pressure level.

The MOE requires that instantaneous sound pressure be processed by a special filter (i.e., A-weighting). As human hearing is less sensitive to low frequency sound, the weighting emphasizes the frequencies in the range 500 Hertz (“Hz”) to 4000 Hz; while progressively diminishing the relative contributions at high and low frequencies. This corresponds approximately to the hearing response to humans at normal sound levels (e.g., 50 dB). The resulting “A-weighted” sound level is often used as a criterion to indicate a maximum allowable sound level.

The MOE defines a “point of reception” as any point on the premises of a person within 30 m of a dwelling or camping area, where sound or vibration originating from other than those premises is received. The MOE designates points of reception into three classes:

- Class 1 refers to an acoustical environment typical of a major population centre where the background noise is dominated by the urban hum. These areas are highly urbanized and have moderate to high noise levels throughout the day and night.
- Class 2 means an area with an acoustic environment that has low ambient sound levels between 19:00 hours and 07:00 hours; where the evening and night-time levels are defined by natural sounds and infrequent human activity and there are no clearly audible sounds from stationary sources (e.g., industrial, commercial, etc.).
- Class 3 refers to areas that are rural and/or small communities with a population of less than 1,000 with an acoustic environment that is dominated by natural sounds and has little or no road traffic during the night-time period.

3.0 DESCRIPTION OF WIND TURBINE SITE AND SURROUNDS

The Project is located near Little Current, in the town of North Eastern Manitoulin and the Islands, Ontario. The closest community in the vicinity of the Project is the Town of Little Current. The dominant environmental feature in the vicinity of the Project is the North Channel in Georgian Bay, located north and east of the study area. (Figure 1).

The wind plant will have a nominal rated nameplate capacity of 72 MW and will include one transformer at a substation near Green Bush Rd between McLean's Mountain Rd and Columbas Mountain Rd (Figure 2).

Within this agricultural / rural area, the main sources of ambient sound that currently exist include:

1. Vehicular traffic on County and Concession roads.
2. Sounds due to human activity as well as agricultural and rural activities.
3. Sounds due to human domestic activities such as property maintenance and recreation.
4. Natural sounds from wind noise, insects, wildlife, atmospheric effects, etc.

The acoustic classification of the area is generally Class 3 (rural).

3.1 Description of Receptors

Noise receptors have been selected for this analysis based on two criteria: i) their spatial proximity to the Project (i.e., receptors within about 1.5 kilometers of a wind turbine); and ii) level of benefit derived from the Project (e.g., participating or non-participating receptors). However, it should be noted that this project does not include any participating receptors. In addition, vacant lots have been considered as containing receptors if they are accessible – i.e., if they are adjacent to a road. The location of the receptor within each vacant lot has been chosen to be consistent with the typical building pattern in the area (e.g., close to adjacent roads) or at the centre of the vacant lot as per MOE documentation (see Attachment A). A total of 297 receptor dwellings and 49 vacant lots have been included as receptors for this assessment.

All receptors in the study area were provided to Aercoustics by NPI. Each receptor has been assigned a unique identifier for modelling and reporting purposes. Their locations relative to the wind turbines and transformer station are shown in Figure 2.

For the purposes of this ENIA, points of reception have been modelled at the worst case scenario of either two storey dwelling, or single storey dwelling with one point of reception 4.5m above the centre of the house.

3.2 MOE Environmental Noise Limits

The sound limit requirements for a wind turbine or an array of such units, termed a “wind plant”, have been established in accordance with the existing MOE publications (NPC-205/232/233) as well as the wind induced background noise level. The specific definition of sound limits, expressed as a function of wind speed and ambient noise levels, as outlined in the MOE Interpretation, includes the following:

3.2.1 *Wind Turbine Installations in Class 1 & 2 Areas (Urban): Wind Speeds Below 8m/s*

The lowest sound level limit at a Point of Reception in Class 1 and 2 Areas (Urban), under conditions of average wind speed up to 8 m/s (i.e., 29km/h), expressed in terms of the hourly L_{eq} is 45.0 dBA or the minimum hourly background sound level established in accordance with requirements in Publications NPC-205/NPC-233, whichever is higher.

3.2.2 *Wind Turbine Installations In Class 3 Areas (Rural): Wind Speeds Below 6m/s*

The lowest sound level limit at a Point of Reception in Class 3 Areas (Rural), under conditions of average wind speed up to 6 m/s (i.e., 22km/h), expressed in terms of the hourly L_{eq} is 40.0 dBA or the minimum hourly background sound level established in accordance with requirements in Publications NPC-232/NPC-233, whichever is higher.

3.2.3 Wind Turbine Installations In Class 1 & 2 and Class 3 Areas: Wind Speeds Above 8m/s and 6m/s Respectively

The sound level limit at a Point of Reception in Class Areas 1 & 2 (Urban) or in Class 3 Areas (Rural), under conditions of average wind speed above 8 m/s and 6m/s respectively, expressed in terms of the hourly L_{eq} , is the wind induced background sound level, expressed in terms of ninetieth percentile sound level (L_{A90}) plus 7 dB, or the minimum hourly background sound level established in accordance with requirements in Publications NPC-205/NPC-232/NPC-233, whichever is higher. A summary of the above limits is shown in Table 1 for continued reference.

Table 1: MOE Sound Level Limits at Points of Reception for Wind Plants							
Wind Speed (m/s)	4 m/s	5 m/s	6 m/s	7 m/s	8 m/s	9 m/s	10 m/s
Wind Turbine Noise Criterion NPC-232 (dBA) Class 3	40.0	40.0	40.0	43.0	45.0	49.0	51.0
Wind Turbine Noise Criterion NPC-205 (dBA) Class 1 & 2	45.0	45.0	45.0	45.0	45.0	49.0	51.0

Notes:

1. The measurement of wind induced background sound level is not required to establish the applicable criterion. The wind induced background sound level reference curve was determined by correlating the ninetieth percentile sound level (L_{A90}) with the average wind speed measured at a particularly quiet site.
2. If the existing minimum hourly background sound level, established in accordance with requirements in Publications NPC-205/NPC-232/NPC-233, is selected as the sound level limit, the measurement of wind speed (for the purpose of determination of wind induced background sound level) is not required. The selected limit applies in the entire range of wind speed under consideration from 4m/s to 11m/s with the exception of wind turbine noise criterion values higher than the existing minimum hourly background sound level.
3. Wind Turbine Noise Criterion at wind speeds expressed as fractional values of m/s should be interpolated from the above table.

The Project sound limits are ultimately a function of several variables:

1. Current ambient levels due to sound levels caused by both natural and human activity (e.g., traffic) sounds.
2. Acoustic classification of the study area (e.g., Class 2 and/or Class 3 as defined by MOE).
3. Wind induced background sound levels.

It should be noted that the ENIA has opted to apply the more conservative Class 3 (Rural) values to all territories within the study area. Table 2 summarizes the sound level limits for Class 3 areas.

Wind Speed (m/s)	4 m/s	5 m/s	6 m/s	7 m/s	8 m/s	9 m/s	10 m/s
Wind Turbine Sound Level Limit (dBA) (Class 3 Area, NPC-232)	40.0	40.0	40.0	43.0	45.0	49.0	51.0

4.0 DESCRIPTION OF SOURCES

4.1 M1 Transformer Station

NPI plans to build a transformer substation near Green Bush Rd between McLean's Mountain Rd and Columbas Mountain Rd as part of the Project. This substation will contain one transformer unit.

The transformer proposed to be used is a unit rated at 66 MVA (ONAF). The overall dimension of the unit is 8.9m x 6.1m x 3.9m (length x width x height), and drawings are included in Figure 3. The sound power level of this unit has been determined to be 89.4 dBA, based on IEEE standard C57.12.90-1993 – Part I [15].

Transformer noise is comprised of casing noise emitted from the operating transformer itself and cooling fan noise. Transformer noise has a pronounced audible tonal quality and therefore incurs a 5dB penalty, as per MOE publication NPC-104[7]. The overall sound power level of the transformer, including this penalty, is 94.4 dBA.

The noise contribution from the substation is calculated using the DataKustik CadnaA version 3.7 environmental noise prediction software. The calculations are based on established prediction methods approved by the MOE: ISO 9613-2 standard entitled "Acoustics – Attenuation of sound during propagation outdoors – Part 2: General method of calculation". For this analysis, the noise contribution from the substation was added to the noise contributions of the wind turbines to assess the total cumulative effect of the Project.

Table 3 lists the location of the transformer.

Table 3: Transformer Location			
Identifier	UTM Coordinates		Remarks
	X (m)	Y (m)	
Xfrmr	423616	5087363	M1 Windfarm

4.2 Wind Turbine Generators

The Project will utilize GE model 2.5-103 2.5MW wind turbines. Each turbine has three blades, a 103m rotor diameter, and a hub height of 100m.

The turbines are capable of operating in seven modes – Normal Operation (NO) mode and Noise Reduced Operation (NRO) mode 103 to 100. Normal Operation corresponds to the most favourable power curve, but also the highest nominal sound power level at 104 dBA. NRO 103 to 100 corresponds to nominal calculated sound power levels from 103 dBA to 100 dBA. All turbines in the Project will operate using NO mode, corresponding to a nominal sound power level of 104 dBA.

Additional information on the GE 2.5-103 turbines is provided in Attachment B. Turbine coordinates are listed in Table 4.

4.2.1 Potential Sources of Noise

There are several sources that contribute to the sound emitted by a typical wind turbine. As the rotating blades of the turbine extract power from the air-stream, the blades experience lift and drag forces. These forces generate sound, much in the same manner as a rotating propeller or fan – also known as aerodynamic noise

INFRASOUND

Sounds with frequency contents below 20 Hz are referred to as infrasound. There are many other sources of infrasound such as those generated by winds, waterfalls, and the sound of waves breaking on the beach. Measurements at 200 m from typical units have shown that the infrasound levels are well below the level of perceptibility [1], [2]. As noted above, there are no non-participating Points of Reception within 400 m of a wind turbine and thus the potential effect of infrasound is not anticipated.

AMPLITUDE MODULATION

Perceptible sounds are generated predominantly by mechanical bearings, the electric generator and a characteristic “swoosh” which is essentially higher frequency broadband noise that is amplitude modulated at a low frequency [3]. In contrast to the first-generation wind turbines, some 30 years ago, innovations in blade geometry, materials, and mechanical systems have significantly lowered the sound power levels of present generation wind turbines. A recent study of wind turbine noise amplitude modulation [3] by the University of Salford, UK found that

amplitude modulation occurs between 7% and 15% of the time, but the causes of amplitude modulation are still open to debate therefore the causes are not fully understood and that amplitude modulation cannot be fully predicted by current state of the art. The Salford study concludes that further research is recommended to improve understanding of amplitude modulation. The MOE does not impose a penalty applied to wind turbine noise due to amplitude modulation [17].

WIND SHEAR EFFECTS

Vertical Wind shear, sometimes referred to as wind shear or wind gradient, is a vertical difference in wind speed and direction over a relatively short distance in the atmosphere. For acoustic purposes, vertical wind shear is used as a measure of the change in wind speed at various vertical heights above ground level. Wind shear has been accounted for in the M1 noise assessment by adjusting the standard neutral stability wind turbine emission to an emission which accounts for the site specific average summer night time wind shear exponent. This approach is consistent with the recommendations of the MOE's Noise Guidelines for Wind Farms [17].

4.2.2 M1 Wind Turbine Noise Emission Rating

GE has provided NPI with noise emission performance for the GE 2.5-103 wind turbines (NO mode) for wind speeds of 6ms/ to 10m/s at a reference height of 10m. See Attachment B and Table 4 below.

Table 4: GE 2.5-103, Sound Power Spectrums at wind speeds from 6m/s to 10m/s										
GE 2.5-103 Electrical Rating: 2.5 MW Hub Height (m): 100m Wind Shear coefficient: 0.435										
	Octave Band Sound Power Level (dB)									
	Manufacturer's Emission Levels					Adjusted Emission Levels**				
Wind Speed* (m/s)	6	7	8	9	10-cutout	6	7	8	9	10
Frequency (Hz)										
31.5	78.4	80.8	80.9	81.1	81.1	81.1	81.1	81.1	81.1	81.1
63	88.1	90.5	90.5	90.7	90.8	90.8	90.8	90.8	90.8	90.8
125	92.3	94.6	94.7	94.9	94.9	94.9	94.9	94.9	94.9	94.9
250	94.7	96.4	95.7	95.9	95.9	95.9	95.9	95.9	95.9	95.9
500	95.7	97.3	96.2	95.4	95.2	95.2	95.2	95.2	95.2	95.2
1000	96.6	98.4	98.7	98.6	98.4	98.4	98.4	98.4	98.4	98.4
2000	93.2	95.7	96.9	97.3	97.6	97.6	97.6	97.6	97.6	97.6
4000	86.2	87.5	88.1	89.0	89.4	89.4	89.4	89.4	89.4	89.4
8000	70.3	71.6	71.4	71.4	71.0	71.0	71.0	71.0	71.0	71.0
Total dBA	102.1	104.0	104.0	104.0	104.0	104.0	104.0	104.0	104.0	104.0

* At 10m reference height.

** The site specific average summer night time wind shear exponent was provided by AWS Truewind, wind engineering consultants for Northland Power Inc on this project. Given the wind shear coefficient of 0.435, the cut-out sound power level of 104 dBA corresponding to a wind speed of 10 m/s was used for all wind speeds. i.e. the highest noise emission from the turbines is used for all the wind speed cases. It should be

noted that the overall total sound emission is guaranteed by GE. The spectral data is for modelling purposes only and is not explicitly guaranteed.

Table 5 shows the proposed wind turbine locations.

Table 5: Wind Turbine Locations				
Identifier	Equipment Make, Model	UTM Coordinates		Remarks
		X (m)	Y (m)	
T05	GE 2.5-103 2.5MW	425967	5088867	M1 Windfarm
T06	GE 2.5-103 2.5MW	425374	5088648	M1 Windfarm
T09	GE 2.5-103 2.5MW	426960	5088349	M1 Windfarm
T10	GE 2.5-103 2.5MW	426243	5088273	M1 Windfarm
T11	GE 2.5-103 2.5MW	423155	5087692	M1 Windfarm
T12	GE 2.5-103 2.5MW	424685	5087875	M1 Windfarm
T13	GE 2.5-103 2.5MW	425578	5087836	M1 Windfarm
T14	GE 2.5-103 2.5MW	424005	5087874	M1 Windfarm
T15	GE 2.5-103 2.5MW	426514	5087605	M1 Windfarm
T16	GE 2.5-103 2.5MW	423976	5085277	M1 Windfarm
T17	GE 2.5-103 2.5MW	421160	5086508	M1 Windfarm
T18	GE 2.5-103 2.5MW	423020	5086314	M1 Windfarm
T19	GE 2.5-103 2.5MW	426002	5086354	M1 Windfarm
T20	GE 2.5-103 2.5MW	425263	5086379	M1 Windfarm
T21	GE 2.5-103 2.5MW	420869	5086170	M1 Windfarm
T23	GE 2.5-103 2.5MW	423091	5085958	M1 Windfarm
T25	GE 2.5-103 2.5MW	415729	5084615	M1 Windfarm
T28	GE 2.5-103 2.5MW	424742	5084943	M1 Windfarm
T29	GE 2.5-103 2.5MW	423719	5084978	M1 Windfarm
T30	GE 2.5-103 2.5MW	424258	5084654	M1 Windfarm
T31	GE 2.5-103 2.5MW	416174	5082550	M1 Windfarm
T34	GE 2.5-103 2.5MW	423970	5084235	M1 Windfarm
T35	GE 2.5-103 2.5MW	415668	5083842	M1 Windfarm
T36	GE 2.5-103 2.5MW	416181	5083552	M1 Windfarm
T38	GE 2.5-103 2.5MW	415679	5083197	M1 Windfarm
T39	GE 2.5-103 2.5MW	417095	5082519	M1 Windfarm
T40	GE 2.5-103 2.5MW	416441	5082915	M1 Windfarm
T42	GE 2.5-103 2.5MW	415354	5082675	M1 Windfarm
T43	GE 2.5-103 2.5MW	416653	5082179	M1 Windfarm

4.2.3 Providence Bay Wind Farm

The Providence Bay Wind Farm is an operating 1.6 MW wind farm located near the towns of Providence Bay and Spring Bay, in the Township of Central Manitoulin, Manitoulin Island Ontario. Two Enercon E-48 800 kW wind turbine generators were commissioned and put into operation at Providence Bay on March 25, 2007. The related Providence Bay Expansion Project is in the Advanced-Stage of development.

As the Providence Bay is located more than 10km away from boundary of M1 wind farm, the total noise impact assessment on the M1 wind farm points of reception does not include the noise impact from Providence Bay wind farm

5.0 NOISE ASSESSMENT RESULTS

5.1 Transformer Station Impact Assessment

The overall sound power level of the transformer unit, including 5dB tonality penalty, is 94.4 dBA. DataKustik CadnaA environmental noise model generated the worst-case results shown in Table 6. These results include contributions of the wind turbines. As indicated in the table, and applying the conservative application of Class 3 (rural) areas to all Points of Reception, the transformer are expected to meet the applicable noise guidelines. The receptor identified in Table 6 is the worst-case receptor, closest to the transformer.

Table 6: Total Noise Impact, 6m/s wind speed				
Receptor	Description	Distance to Transformer (m)	Calculated Sound Level (dBA)	Allowable Level
R289	Residence, (on Green Bush Road)	405	40.0 dBA	40.0 dBA

5.2 Wind Turbine Impact Assessment

The noise impact at 297 receptor dwellings and 49 vacant lots has been predicted using a formula based on ISO 9613-2 Part 2; consistent with the MOE's modelling requirements. The locations and sound power levels of all the wind turbine sources, the transformer station sources and the location of the receptors were integrated into a master data file.

Noise was predicted based on the following noise modelling protocol:

- Temperature = 10C
- Humidity = 70%
- G = 0.70 global ground attenuation factor
- Sound Level Limit = 40.0 dBA at 6m/s wind at 10m agl, i.e. precision to 1/10th of decibel
- Turbine noise emission corresponding to the manufacturer's cut-out sound power level at a wind speed of 10m/s at 10m agl, to account for M1 specific conditions of average summer night time wind shear exponent = 0.435
- Analysis to include only turbines within 5km of a receptor for those receptors whose closest turbine is within 1.5km
- Two storey dwelling = 4.5m receptor height at center of dwelling
- Single storey dwelling = 4.5m receptor height at center of dwelling
- Vacant lot = 4.5m receptor height at position described in section 3.1: Description of Receptors

The highest noise level for each receptor, which represents the worst-case prediction, is outlined in the assessment summary table at the end of this report.

The noise modelling software computes the octave band levels at the receptors from all the sound sources, including the transformer. The resultant A-weighted sound pressure levels are then transferred as a noise contour to the site map that shows both source and receiver locations. Refer to Figure 5 for the noise contour.

Worst-case sound levels have been predicted at all 297 dwellings and 49 vacant lots. A Sample detailed calculation is provided in Attachment C. The worst-case predicted sound levels at all receptors are predicted to be within the MOE environmental noise limits for Class 3 (rural) areas.

5.3 Wind Turbine Summary Tables

The sound power emitted by the wind turbines and transformer station, as well as their location with respect to the receptors determines the sound pressure levels induced by the operation of all Project components. The acoustic power of each wind turbine as provided by the manufacturer is shown in Attachment B.

The total noise impact at each receptor, including all wind turbines and transformer stations, has been summarized in the noise assessment summary table below for all 297 dwellings and 49 vacant lots. The noise impact from the simultaneous operation of all wind turbines and transformers is less than or equal to the sound level limit associated with NPC 232 (i.e., 40.0 dBA).

The closest receptor to a proposed M1 wind turbine is V229, which is located 562m from turbine T17. All other receptors are more than 562m from a turbine. The closest receptor dwelling (non-vacant lot) is R289 which is located 669m from turbine T11.

6.0 CONCLUSION

The project site is rural: therefore the MOE’s Class 3 (rural) designation applies.

Building upon the project specific sound limit guidelines, noise impact prediction modelling was undertaken. The noise impact on the nearest points of reception was predicted using an acoustic model, ISO 9613, as required by the MOE, based on noise from the Project’s wind turbine array, coupled with transformers with transformer tonality penalty.

The noise assessment was based on all of the recommended procedures outlined in the MOE’s “Noise Guidelines for Wind farms, October 2008” [17].

The analysis shows that the cumulative noise impact from the Project does not exceed the most restrictive noise limits that apply for areas with an acoustic designation of Class 3 (Rural) as defined by the MOE. Consequently, there is no need for the application of any additional mitigation measures and no further studies are contemplated for environmental noise in relation to the Project.

REFERENCES:

1. *Infrasound Emission from Wind Turbines*, Jorgen Jakobsen, Danish Environmental Protection Agency, 17 Aug 2005
2. *Infrasound from Wind Turbines-Fact, Fiction or Deception*, Geoff Leventhall, Journal of Canadian Acoustical Association, 2006
3. *Research into Aerodynamic Modulation of Wind Turbine Noise*, University of Salford, Dr. Andy Moorhouse, Malcolm Hayes, Dr. Sabine von Hunerbein, Ben Piper, Dr. Mags Adams, for Department for Business Enterprise, & Regulatory Reform, UK, July 2007.
4. *Wind Turbine Facilities Noise Issues*, for the MOE, by Aiolos Engineering Corporation, Dr. Ramani Ramakrishnan, December 2007.
5. *NPC-102 – Instrumentation*, Ontario Ministry of Environment
6. *NPC-103 – Procedures*, Ontario Ministry of Environment
7. *NPC-104 – Sound Level Adjustments*, Ontario Ministry of Environment
8. *NPC-205 – Sound Level Limits for Stationary Sources in Class 1 & 2 Areas (Urban)*, Ontario Ministry of Environment
9. *NPC-206 – Sound Levels due to Road Traffic*, Ontario Ministry of Environment
10. *NPC-232 – Sound Level Limits for Stationary Sources in Class 3 Areas (Rural)*, Ontario Ministry of Environment
11. *NPC-233 – Information to be Submitted for Approval of Stationary Sources of Sound*, Ontario Ministry of Environment
12. *IEC 61400-11- “Wind turbine generator systems – Part 11: Acoustic noise measurement techniques – International Restrictions”*, Dec. 2002
13. *ISO-9613-2 – “Acoustics – Attenuation of sound propagation outdoors – Part 2: General method of calculation”*, Dec. 1996
14. *ETSU-R-97 – “The Assessment and Rating of Noise from Wind Farms”*, Final Report, September 1996.
15. *IEEE C57.12.90-1993 – Part I: IEEE Standard Test Code for Liquid – Immersed, Distribution, Power, and Regulating Transformers*
16. *CAN/CSA-C88-M90 – Power Transformers and Reactors – Electrical Power Systems and Equipment – A National Standard of Canada (Reaffirmed 2004)*
17. *PIBS 4709e - Noise Guidelines for Wind Farms, Interpretation for Applying MOE NPC Publications to Wind Power Generation Facilities*, Ontario Ministry of Environment, October 2008
18. *Environmental Noise Impact Assessment, Port Alma Wind Power Project*, Aercoustics Engineering Limited, 31 March 2008

Point of Reception ID	Receptor Height [m]	Receptor Description			Distance to nearest Turbine [m]	Turbine ID	Calculated Sound Pressure Level [dBA] at Selected Windspeed [m/s]					Sound Level Limit [dBA] at Selected Windspeed [m/s]					Compliance with Limit [Yes/No]
			Easting	Northing			<=6	7	8	9	10	<=6	7	8	9	10	
R001	4.5	Residence	425848	5083118	2134	T28	28.9	28.9	28.9	28.9	28.9	40	43	45	49	51	Yes
R002	4.5	Residence	425770	5083073	2134	T28	29.0	29.0	29.0	29.0	29.0	40	43	45	49	51	Yes
R003	4.5	Residence	425207	5083180	1626	T34	31.1	31.1	31.1	31.1	31.1	40	43	45	49	51	Yes
R004	4.5	Residence	424906	5082966	1577	T34	30.9	30.9	30.9	30.9	30.9	40	43	45	49	51	Yes
R005	4.5	Residence	424795	5083040	1452	T34	31.5	31.5	31.5	31.5	31.5	40	43	45	49	51	Yes
R006	4.5	Residence	424422	5082993	1322	T34	32.1	32.1	32.1	32.1	32.1	40	43	45	49	51	Yes
R007	4.5	Residence	424307	5083188	1100	T34	33.5	33.5	33.5	33.5	33.5	40	43	45	49	51	Yes
R008	4.5	Residence	423155	5083142	1363	T34	31.7	31.7	31.7	31.7	31.7	40	43	45	49	51	Yes
R009	4.5	Residence	422309	5083084	2021	T34	28.3	28.3	28.3	28.3	28.3	40	43	45	49	51	Yes
R010	4.5	Residence	421365	5083081	2849	T34	24.5	24.5	24.5	24.5	24.5	40	43	45	49	51	Yes
R011	4.5	Residence	414344	5081036	1925	T42	29.3	29.3	29.3	29.3	29.3	40	43	45	49	51	Yes
R012	4.5	Residence	414311	5081196	1810	T42	29.7	29.7	29.7	29.7	29.7	40	43	45	49	51	Yes
R013	4.5	Residence	414299	5081242	1779	T42	29.8	29.8	29.8	29.8	29.8	40	43	45	49	51	Yes
R014	4.5	Residence	414412	5081942	1194	T42	32.9	32.9	32.9	32.9	32.9	40	43	45	49	51	Yes
R015	4.5	Residence	414235	5081847	1392	T42	31.6	31.6	31.6	31.6	31.6	40	43	45	49	51	Yes
R016	4.5	Residence	414339	5082499	1030	T42	33.6	33.6	33.6	33.6	33.6	40	43	45	49	51	Yes
R017	4.5	Residence	414409	5082880	967	T42	35.0	35.0	35.0	35.0	35.0	40	43	45	49	51	Yes
R018	4.5	Residence	414380	5082933	1008	T42	34.8	34.8	34.8	34.8	34.8	40	43	45	49	51	Yes
R019	4.5	Residence	414270	5083098	1164	T42	33.9	33.9	33.9	33.9	33.9	40	43	45	49	51	Yes
R020	4.5	Residence	413725	5082956	1653	T42	29.9	29.9	29.9	29.9	29.9	40	43	45	49	51	Yes
R021	4.5	Residence	413701	5082942	1674	T42	29.8	29.8	29.8	29.8	29.8	40	43	45	49	51	Yes
R022	4.5	Residence	413750	5082896	1619	T42	27.4	27.4	27.4	27.4	27.4	40	43	45	49	51	Yes
R023	4.5	Residence	413784	5082742	1571	T42	26.4	26.4	26.4	26.4	26.4	40	43	45	49	51	Yes
R024	4.5	Residence	413775	5082673	1579	T42	25.7	25.7	25.7	25.7	25.7	40	43	45	49	51	Yes
R025	4.5	Residence	413675	5082506	1687	T42	25.0	25.0	25.0	25.0	25.0	40	43	45	49	51	Yes
R026	4.5	Residence	413581	5082369	1799	T42	27.0	27.0	27.0	27.0	27.0	40	43	45	49	51	Yes
R027	4.5	Residence	413606	5082202	1811	T42	24.3	24.3	24.3	24.3	24.3	40	43	45	49	51	Yes
R028	4.5	Residence	413448	5082021	2015	T42	24.8	24.8	24.8	24.8	24.8	40	43	45	49	51	Yes
R029	4.5	Residence	413396	5081968	2082	T42	24.5	24.5	24.5	24.5	24.5	40	43	45	49	51	Yes
R030	4.5	Residence	413345	5081912	2149	T42	25.2	25.2	25.2	25.2	25.2	40	43	45	49	51	Yes
R031	4.5	Residence	413290	5081850	2223	T42	23.9	23.9	23.9	23.9	23.9	40	43	45	49	51	Yes
R032	4.5	Residence	413255	5081810	2270	T42	23.8	23.8	23.8	23.8	23.8	40	43	45	49	51	Yes
R033	4.5	Residence	413185	5081718	2371	T42	23.4	23.4	23.4	23.4	23.4	40	43	45	49	51	Yes
R034	4.5	Residence	413172	5081643	2414	T42	22.4	22.4	22.4	22.4	22.4	40	43	45	49	51	Yes
R035	4.5	Residence	413128	5081605	2470	T42	22.2	22.2	22.2	22.2	22.2	40	43	45	49	51	Yes
R036	4.5	Residence	413108	5081561	2507	T42	22.1	22.1	22.1	22.1	22.1	40	43	45	49	51	Yes
R037	4.5	Residence	413089	5081537	2535	T42	22.0	22.0	22.0	22.0	22.0	40	43	45	49	51	Yes
R038	4.5	Residence	413062	5081495	2578	T42	21.8	21.8	21.8	21.8	21.8	40	43	45	49	51	Yes
R039	4.5	Residence	413030	5081446	2629	T42	21.6	21.6	21.6	21.6	21.6	40	43	45	49	51	Yes
R040	4.5	Residence	413002	5081405	2673	T42	21.5	21.5	21.5	21.5	21.5	40	43	45	49	51	Yes
R041	4.5	Residence	412988	5081382	2696	T42	21.4	21.4	21.4	21.4	21.4	40	43	45	49	51	Yes
R042	4.5	Residence	412964	5081349	2733	T42	21.3	21.3	21.3	21.3	21.3	40	43	45	49	51	Yes
R043	4.5	Residence	412949	5081327	2757	T42	21.2	21.2	21.2	21.2	21.2	40	43	45	49	51	Yes
R044	4.5	Residence	412942	5081315	2769	T42	21.2	21.2	21.2	21.2	21.2	40	43	45	49	51	Yes
R045	4.5	Residence	413762	5083132	1656	T42	29.8	29.8	29.8	29.8	29.8	40	43	45	49	51	Yes

Point of Reception ID	Receptor Height [m]	Receptor Description			Distance to nearest Turbine [m]	Turbine ID	Calculated Sound Pressure Level [dBA] at Selected Windspeed [m/s]					Sound Level Limit [dBA] at Selected Windspeed [m/s]					Compliance with Limit [Yes/No]
			Easting	Northing			<=6	7	8	9	10	<=6	7	8	9	10	
R046	4.5	Residence	413720	5083178	1710	T42	30.0	30.0	30.0	30.0	30.0	40	43	45	49	51	Yes
R047	4.5	Residence	413696	5083199	1739	T42	29.8	29.8	29.8	29.8	29.8	40	43	45	49	51	Yes
R048	4.5	Residence	413683	5083273	1775	T42	30.1	30.1	30.1	30.1	30.1	40	43	45	49	51	Yes
R049	4.5	Residence	413601	5083352	1879	T42	30.1	30.1	30.1	30.1	30.1	40	43	45	49	51	Yes
R050	4.5	Residence	413574	5083324	1895	T42	29.9	29.9	29.9	29.9	29.9	40	43	45	49	51	Yes
R051	4.5	Residence	413495	5083401	1996	T42	29.7	29.7	29.7	29.7	29.7	40	43	45	49	51	Yes
R052	4.5	Residence	413491	5083827	2177	T35	29.4	29.4	29.4	29.4	29.4	40	43	45	49	51	Yes
R053	4.5	Residence	413825	5084524	1906	T25	30.0	30.0	30.0	30.0	30.0	40	43	45	49	51	Yes
R054	4.5	Residence	414213	5084742	1521	T25	31.3	31.3	31.3	31.3	31.3	40	43	45	49	51	Yes
R055	4.5	Residence	414370	5083886	1299	T35	33.9	33.9	33.9	33.9	33.9	40	43	45	49	51	Yes
R056	4.5	Residence	414371	5083958	1302	T35	33.8	33.8	33.8	33.8	33.8	40	43	45	49	51	Yes
R057	4.5	Residence	414879	5085178	1020	T25	32.6	32.6	32.6	32.6	32.6	40	43	45	49	51	Yes
R058	4.5	Residence	414972	5085133	917	T25	33.1	33.1	33.1	33.1	33.1	40	43	45	49	51	Yes
R059	4.5	Residence	414307	5085243	1554	T25	30.3	30.3	30.3	30.3	30.3	40	43	45	49	51	Yes
R060	4.5	Residence	414272	5085861	1917	T25	28.0	28.0	28.0	28.0	28.0	40	43	45	49	51	Yes
R061	4.5	Residence	414215	5085774	1907	T25	28.1	28.1	28.1	28.1	28.1	40	43	45	49	51	Yes
R062	4.5	Residence	414183	5085687	1881	T25	28.3	28.3	28.3	28.3	28.3	40	43	45	49	51	Yes
R063	4.5	Residence	414143	5085669	1904	T25	28.2	28.2	28.2	28.2	28.2	40	43	45	49	51	Yes
R064	4.5	Residence	414087	5085618	1924	T25	28.2	28.2	28.2	28.2	28.2	40	43	45	49	51	Yes
R065	4.5	Residence	414056	5085605	1944	T25	27.2	27.2	27.2	27.2	27.2	40	43	45	49	51	Yes
R066	4.5	Residence	415497	5086237	1639	T25	26.6	26.6	26.6	26.6	26.6	40	43	45	49	51	Yes
R067	4.5	Residence	415594	5086574	1964	T25	24.9	24.9	24.9	24.9	24.9	40	43	45	49	51	Yes
R068	4.5	Residence	415432	5086625	2032	T25	24.5	24.5	24.5	24.5	24.5	40	43	45	49	51	Yes
R069	4.5	Residence	415396	5086649	2061	T25	24.4	24.4	24.4	24.4	24.4	40	43	45	49	51	Yes
R070	4.5	Residence	415344	5086540	1963	T25	24.9	24.9	24.9	24.9	24.9	40	43	45	49	51	Yes
R071	4.5	Residence	415301	5086495	1928	T25	25.8	25.8	25.8	25.8	25.8	40	43	45	49	51	Yes
R072	4.5	Residence	415476	5086730	2130	T25	24.1	24.1	24.1	24.1	24.1	40	43	45	49	51	Yes
R073	4.5	Residence	415503	5086756	2153	T25	24.0	24.0	24.0	24.0	24.0	40	43	45	49	51	Yes
R074	4.5	Residence	415549	5086772	2164	T25	23.9	23.9	23.9	23.9	23.9	40	43	45	49	51	Yes
R075	4.5	Residence	415571	5086817	2208	T25	23.7	23.7	23.7	23.7	23.7	40	43	45	49	51	Yes
R076	4.5	Residence	415627	5086826	2213	T25	23.7	23.7	23.7	23.7	23.7	40	43	45	49	51	Yes
R077	4.5	Residence	415617	5086891	2279	T25	23.4	23.4	23.4	23.4	23.4	40	43	45	49	51	Yes
R078	4.5	Residence	415731	5086962	2347	T25	23.1	23.1	23.1	23.1	23.1	40	43	45	49	51	Yes
R079	4.5	Residence	415781	5087030	2416	T25	22.9	22.9	22.9	22.9	22.9	40	43	45	49	51	Yes
R080	4.5	Residence	415836	5087086	2473	T25	22.6	22.6	22.6	22.6	22.6	40	43	45	49	51	Yes
R081	4.5	Residence	415995	5087198	2597	T25	22.2	22.2	22.2	22.2	22.2	40	43	45	49	51	Yes
R082	4.5	Residence	415941	5087220	2614	T25	22.0	22.0	22.0	22.0	22.0	40	43	45	49	51	Yes
R083	4.5	Residence	415453	5087273	2672	T25	22.9	22.9	22.9	22.9	22.9	40	43	45	49	51	Yes
R084	4.5	Residence	416012	5087285	2685	T25	21.8	21.8	21.8	21.8	21.8	40	43	45	49	51	Yes
R085	4.5	Residence	416038	5087334	2737	T25	21.7	21.7	21.7	21.7	21.7	40	43	45	49	51	Yes
R086	4.5	Residence	416093	5087356	2765	T25	21.6	21.6	21.6	21.6	21.6	40	43	45	49	51	Yes
R087	4.5	Residence	416094	5087400	2809	T25	21.4	21.4	21.4	21.4	21.4	40	43	45	49	51	Yes
R088	4.5	Residence	416150	5087427	2843	T25	21.1	21.1	21.1	21.1	21.1	40	43	45	49	51	Yes
R089	4.5	Residence	416234	5087588	3016	T25	20.4	20.4	20.4	20.4	20.4	40	43	45	49	51	Yes
R090	4.5	Residence	419777	5089027	2874	T17	21.0	21.0	21.0	21.0	21.0	40	43	45	49	51	Yes

Point of Reception ID	Receptor Height [m]	Receptor Description			Distance to nearest Turbine [m]	Turbine ID	Calculated Sound Pressure Level [dBA] at Selected Windspeed [m/s]					Sound Level Limit [dBA] at Selected Windspeed [m/s]					Compliance with Limit [Yes/No]
			Easting	Northing			<=6	7	8	9	10	<=6	7	8	9	10	
R091	4.5	Residence	419708	5089143	3009	T17	19.9	19.9	19.9	19.9	19.9	40	43	45	49	51	Yes
R092	4.5	Residence	419681	5089119	3001	T17	19.9	19.9	19.9	19.9	19.9	40	43	45	49	51	Yes
R093	4.5	Residence	419277	5090192	4137	T17	19.2	19.2	19.2	19.2	19.2	40	43	45	49	51	Yes
R094	4.5	Residence	419206	5090217	4192	T17	19.1	19.1	19.1	19.1	19.1	40	43	45	49	51	Yes
R095	4.5	Residence	418890	5089158	3489	T17	17.1	17.1	17.1	17.1	17.1	40	43	45	49	51	Yes
R096	4.5	Residence	418649	5089115	3620	T17	16.7	16.7	16.7	16.7	16.7	40	43	45	49	51	Yes
R097	4.5	Residence	418572	5089260	3778	T17	16.3	16.3	16.3	16.3	16.3	40	43	45	49	51	Yes
R098	4.5	Residence	418439	5089067	3735	T17	16.3	16.3	16.3	16.3	16.3	40	43	45	49	51	Yes
R099	4.5	Residence	418387	5089036	3752	T17	16.2	16.2	16.2	16.2	16.2	40	43	45	49	51	Yes
R100	4.5	Residence	418218	5088922	3806	T17	14.2	14.2	14.2	14.2	14.2	40	43	45	49	51	Yes
R101	4.5	Residence	418170	5088875	3814	T17	14.2	14.2	14.2	14.2	14.2	40	43	45	49	51	Yes
R102	4.5	Residence	418135	5088810	3801	T21	14.3	14.3	14.3	14.3	14.3	40	43	45	49	51	Yes
R103	4.5	Residence	418091	5088876	3876	T17	14.1	14.1	14.1	14.1	14.1	40	43	45	49	51	Yes
R104	4.5	Residence	418054	5088846	3884	T21	14.1	14.1	14.1	14.1	14.1	40	43	45	49	51	Yes
R105	4.5	Residence	418002	5088790	3884	T21	14.1	14.1	14.1	14.1	14.1	40	43	45	49	51	Yes
R106	4.5	Residence	417938	5088736	3896	T21	14.1	14.1	14.1	14.1	14.1	40	43	45	49	51	Yes
R107	4.5	Residence	417895	5088692	3899	T21	14.1	14.1	14.1	14.1	14.1	40	43	45	49	51	Yes
R108	4.5	Residence	417814	5088726	3983	T21	13.9	13.9	13.9	13.9	13.9	40	43	45	49	51	Yes
R109	4.5	Residence	417813	5088662	3943	T21	14.1	14.1	14.1	14.1	14.1	40	43	45	49	51	Yes
R110	4.5	Residence	417775	5088658	3970	T21	14.0	14.0	14.0	14.0	14.0	40	43	45	49	51	Yes
R111	4.5	Residence	417685	5088674	4051	T21	13.8	13.8	13.8	13.8	13.8	40	43	45	49	51	Yes
R112	4.5	Residence	417653	5088682	4081	T21	13.8	13.8	13.8	13.8	13.8	40	43	45	49	51	Yes
R113	4.5	Residence	417684	5088577	3992	T21	14.0	14.0	14.0	14.0	14.0	40	43	45	49	51	Yes
R114	4.5	Residence	417611	5088617	4075	T21	13.8	13.8	13.8	13.8	13.8	40	43	45	49	51	Yes
R115	4.5	Residence	417792	5088013	3587	T21	16.5	16.5	16.5	16.5	16.5	40	43	45	49	51	Yes
R116	4.5	Residence	417573	5088557	4070	T21	13.9	13.9	13.9	13.9	13.9	40	43	45	49	51	Yes
R117	4.5	Residence	417528	5088537	4095	T21	13.9	13.9	13.9	13.9	13.9	40	43	45	49	51	Yes
R118	4.5	Residence	417399	5088504	4182	T21	14.6	14.6	14.6	14.6	14.6	40	43	45	49	51	Yes
R119	4.5	Residence	417294	5088398	4094	T25	17.6	17.6	17.6	17.6	17.6	40	43	45	49	51	Yes
R120	4.5	Residence	417204	5088344	4010	T25	17.8	17.8	17.8	17.8	17.8	40	43	45	49	51	Yes
R121	4.5	Residence	417184	5088328	3988	T25	17.8	17.8	17.8	17.8	17.8	40	43	45	49	51	Yes
R122	4.5	Residence	416992	5088231	3830	T25	18.0	18.0	18.0	18.0	18.0	40	43	45	49	51	Yes
R123	4.5	Residence	417136	5088293	3938	T25	17.9	17.9	17.9	17.9	17.9	40	43	45	49	51	Yes
R124	4.5	Residence	417278	5088168	3876	T25	15.9	15.9	15.9	15.9	15.9	40	43	45	49	51	Yes
R125	4.5	Residence	417267	5088106	3815	T25	16.0	16.0	16.0	16.0	16.0	40	43	45	49	51	Yes
R126	4.5	Residence	416826	5088186	3736	T25	18.1	18.1	18.1	18.1	18.1	40	43	45	49	51	Yes
R127	4.5	Residence	416752	5088186	3715	T25	18.2	18.2	18.2	18.2	18.2	40	43	45	49	51	Yes
R128	4.5	Residence	416648	5087998	3506	T25	18.9	18.9	18.9	18.9	18.9	40	43	45	49	51	Yes
R129	4.5	Residence	416489	5087841	3314	T25	19.6	19.6	19.6	19.6	19.6	40	43	45	49	51	Yes
R130	4.5	Residence	416429	5087760	3222	T25	19.8	19.8	19.8	19.8	19.8	40	43	45	49	51	Yes
R131	4.5	Residence	416284	5087570	3007	T25	20.6	20.6	20.6	20.6	20.6	40	43	45	49	51	Yes
R132	4.5	Residence	416332	5087677	3121	T25	20.1	20.1	20.1	20.1	20.1	40	43	45	49	51	Yes
R133	4.5	Residence	428315	5088492	1363	T09	31.1	31.1	31.1	31.1	31.1	40	43	45	49	51	Yes
R134	4.5	Residence	427915	5089033	1175	T09	32.0	32.0	32.0	32.0	32.0	40	43	45	49	51	Yes
R135	4.5	Residence	427850	5089177	1216	T09	31.2	31.2	31.2	31.2	31.2	40	43	45	49	51	Yes

Point of Reception ID	Receptor Height [m]	Receptor Description			Distance to nearest Turbine [m]	Turbine ID	Calculated Sound Pressure Level [dBA] at Selected Windspeed [m/s]					Sound Level Limit [dBA] at Selected Windspeed [m/s]					Compliance with Limit [Yes/No]
			Easting	Northing			<=6	7	8	9	10	<=6	7	8	9	10	
R136	4.5	Residence	427616	5089226	1095	T09	32.7	32.7	32.7	32.7	32.7	40	43	45	49	51	Yes
R137	4.5	Residence	427256	5087044	930	T15	35.8	35.8	35.8	35.8	35.8	40	43	45	49	51	Yes
R138	4.5	Residence	427499	5086978	1168	T15	34.3	34.3	34.3	34.3	34.3	40	43	45	49	51	Yes
R139	4.5	Residence	427540	5087122	1134	T15	34.5	34.5	34.5	34.5	34.5	40	43	45	49	51	Yes
R140	4.5	Residence	428065	5087013	1660	T15	31.6	31.6	31.6	31.6	31.6	40	43	45	49	51	Yes
R141	4.5	Residence	428189	5087035	1769	T15	31.0	31.0	31.0	31.0	31.0	40	43	45	49	51	Yes
R142	4.5	Residence	420751	5089072	2596	T17	21.9	21.9	21.9	21.9	21.9	40	43	45	49	51	Yes
R143	4.5	Residence	420871	5089092	2600	T17	22.1	22.1	22.1	22.1	22.1	40	43	45	49	51	Yes
R144	4.5	Residence	420985	5089087	2580	T11	22.1	22.1	22.1	22.1	22.1	40	43	45	49	51	Yes
R145	4.5	Residence	421348	5089190	2347	T11	22.8	22.8	22.8	22.8	22.8	40	43	45	49	51	Yes
R146	4.5	Residence	421557	5089211	2205	T11	23.2	23.2	23.2	23.2	23.2	40	43	45	49	51	Yes
R147	4.5	Residence	422092	5089042	1718	T11	25.3	25.3	25.3	25.3	25.3	40	43	45	49	51	Yes
R148	4.5	Residence	422176	5089170	1773	T11	25.1	25.1	25.1	25.1	25.1	40	43	45	49	51	Yes
R149	4.5	Residence	422257	5089097	1667	T11	25.5	25.5	25.5	25.5	25.5	40	43	45	49	51	Yes
R150	4.5	Residence	422606	5088962	1384	T11	32.1	32.1	32.1	32.1	32.1	40	43	45	49	51	Yes
R151	4.5	Residence	422536	5089145	1579	T11	26.0	26.0	26.0	26.0	26.0	40	43	45	49	51	Yes
R152	4.5	Residence	422516	5089548	1963	T11	25.0	25.0	25.0	25.0	25.0	40	43	45	49	51	Yes
R153	4.5	Residence	422511	5089612	2025	T11	24.8	24.8	24.8	24.8	24.8	40	43	45	49	51	Yes
R154	4.5	Residence	422460	5089645	2073	T11	24.6	24.6	24.6	24.6	24.6	40	43	45	49	51	Yes
R155	4.5	Residence	422502	5089691	2103	T11	25.2	25.2	25.2	25.2	25.2	40	43	45	49	51	Yes
R156	4.5	Residence	422501	5089754	2163	T11	25.3	25.3	25.3	25.3	25.3	40	43	45	49	51	Yes
R157	4.5	Residence	422590	5089829	2210	T11	25.6	25.6	25.6	25.6	25.6	40	43	45	49	51	Yes
R158	4.5	Residence	422596	5089787	2168	T11	25.7	25.7	25.7	25.7	25.7	40	43	45	49	51	Yes
R159	4.5	Residence	422609	5089684	2065	T11	25.7	25.7	25.7	25.7	25.7	40	43	45	49	51	Yes
R160	4.5	Residence	422680	5089676	2040	T11	25.9	25.9	25.9	25.9	25.9	40	43	45	49	51	Yes
R161	4.5	Residence	422678	5089714	2078	T11	26.1	26.1	26.1	26.1	26.1	40	43	45	49	51	Yes
R162	4.5	Residence	422675	5089755	2118	T11	26.0	26.0	26.0	26.0	26.0	40	43	45	49	51	Yes
R163	4.5	Residence	422680	5089791	2152	T11	25.9	25.9	25.9	25.9	25.9	40	43	45	49	51	Yes
R164	4.5	Residence	422707	5089868	2222	T11	25.8	25.8	25.8	25.8	25.8	40	43	45	49	51	Yes
R165	4.5	Residence	422748	5089886	2231	T11	25.7	25.7	25.7	25.7	25.7	40	43	45	49	51	Yes
R166	4.5	Residence	422800	5089905	2241	T11	26.2	26.2	26.2	26.2	26.2	40	43	45	49	51	Yes
R167	4.5	Residence	422731	5089673	2026	T11	26.0	26.0	26.0	26.0	26.0	40	43	45	49	51	Yes
R168	4.5	Residence	422731	5089718	2070	T11	26.2	26.2	26.2	26.2	26.2	40	43	45	49	51	Yes
R169	4.5	Residence	422731	5089757	2108	T11	26.1	26.1	26.1	26.1	26.1	40	43	45	49	51	Yes
R170	4.5	Residence	422732	5089824	2174	T11	25.9	25.9	25.9	25.9	25.9	40	43	45	49	51	Yes
R171	4.5	Residence	422788	5089835	2174	T11	26.0	26.0	26.0	26.0	26.0	40	43	45	49	51	Yes
R172	4.5	Residence	422789	5089778	2118	T11	26.1	26.1	26.1	26.1	26.1	40	43	45	49	51	Yes
R173	4.5	Residence	422789	5089728	2069	T11	26.3	26.3	26.3	26.3	26.3	40	43	45	49	51	Yes
R174	4.5	Residence	422791	5089680	2021	T11	26.1	26.1	26.1	26.1	26.1	40	43	45	49	51	Yes
R175	4.5	Residence	422788	5089603	1946	T11	26.1	26.1	26.1	26.1	26.1	40	43	45	49	51	Yes
R176	4.5	Residence	422782	5089544	1889	T11	25.6	25.6	25.6	25.6	25.6	40	43	45	49	51	Yes
R177	4.5	Residence	422786	5089501	1846	T11	25.3	25.3	25.3	25.3	25.3	40	43	45	49	51	Yes
R178	4.5	Residence	422837	5089596	1930	T11	26.2	26.2	26.2	26.2	26.2	40	43	45	49	51	Yes
R179	4.5	Residence	423019	5089466	1779	T11	25.9	25.9	25.9	25.9	25.9	40	43	45	49	51	Yes
R180	4.5	Residence	422713	5089969	2320	T11	25.9	25.9	25.9	25.9	25.9	40	43	45	49	51	Yes

Point of Reception ID	Receptor Height [m]	Receptor Description			Distance to nearest Turbine [m]	Turbine ID	Calculated Sound Pressure Level [dBA] at Selected Windspeed [m/s]					Sound Level Limit [dBA] at Selected Windspeed [m/s]					Compliance with Limit [Yes/No]
			Easting	Northing			<=6	7	8	9	10	<=6	7	8	9	10	
R181	4.5	Residence	422729	5090005	2352	T11	26.7	26.7	26.7	26.7	26.7	40	43	45	49	51	Yes
R182	4.5	Residence	422810	5090000	2334	T11	26.0	26.0	26.0	26.0	26.0	40	43	45	49	51	Yes
R183	4.5	Residence	422847	5090085	2413	T11	26.4	26.4	26.4	26.4	26.4	40	43	45	49	51	Yes
R184	4.5	Residence	422929	5090093	2412	T11	26.6	26.6	26.6	26.6	26.6	40	43	45	49	51	Yes
R185	4.5	Residence	422011	5090004	2580	T11	25.3	25.3	25.3	25.3	25.3	40	43	45	49	51	Yes
R186	4.5	Residence	422479	5090116	2516	T11	26.5	26.5	26.5	26.5	26.5	40	43	45	49	51	Yes
R187	4.5	Residence	422506	5090166	2558	T11	26.4	26.4	26.4	26.4	26.4	40	43	45	49	51	Yes
R188	4.5	Residence	422513	5090218	2606	T11	26.3	26.3	26.3	26.3	26.3	40	43	45	49	51	Yes
R189	4.5	Residence	422602	5090178	2547	T11	26.6	26.6	26.6	26.6	26.6	40	43	45	49	51	Yes
R190	4.5	Residence	422663	5090181	2537	T11	27.1	27.1	27.1	27.1	27.1	40	43	45	49	51	Yes
R191	4.5	Residence	422739	5090180	2523	T11	26.6	26.6	26.6	26.6	26.6	40	43	45	49	51	Yes
R192	4.5	Residence	422656	5090359	2713	T11	26.6	26.6	26.6	26.6	26.6	40	43	45	49	51	Yes
R193	4.5	Residence	422623	5090394	2754	T11	26.4	26.4	26.4	26.4	26.4	40	43	45	49	51	Yes
R194	4.5	Residence	422589	5090438	2804	T11	26.4	26.4	26.4	26.4	26.4	40	43	45	49	51	Yes
R195	4.5	Residence	422822	5090202	2532	T11	27.3	27.3	27.3	27.3	27.3	40	43	45	49	51	Yes
R196	4.5	Residence	422903	5090183	2504	T11	27.0	27.0	27.0	27.0	27.0	40	43	45	49	51	Yes
R197	4.5	Residence	422960	5090180	2496	T11	26.4	26.4	26.4	26.4	26.4	40	43	45	49	51	Yes
R198	4.5	Residence	423010	5090182	2494	T11	26.5	26.5	26.5	26.5	26.5	40	43	45	49	51	Yes
R199	4.5	Residence	423041	5090182	2493	T11	26.6	26.6	26.6	26.6	26.6	40	43	45	49	51	Yes
R200	4.5	Residence	423104	5090182	2478	T14	27.4	27.4	27.4	27.4	27.4	40	43	45	49	51	Yes
R201	4.5	Residence	423190	5090177	2443	T14	27.6	27.6	27.6	27.6	27.6	40	43	45	49	51	Yes
R202	4.5	Residence	423098	5090087	2392	T14	27.0	27.0	27.0	27.0	27.0	40	43	45	49	51	Yes
R203	4.5	Residence	423147	5090088	2374	T14	27.1	27.1	27.1	27.1	27.1	40	43	45	49	51	Yes
R204	4.5	Residence	423094	5090033	2342	T11	27.1	27.1	27.1	27.1	27.1	40	43	45	49	51	Yes
R205	4.5	Residence	422948	5089472	1792	T11	25.8	25.8	25.8	25.8	25.8	40	43	45	49	51	Yes
R206	4.5	Residence	422895	5089462	1789	T11	25.7	25.7	25.7	25.7	25.7	40	43	45	49	51	Yes
R207	4.5	Residence	422844	5089599	1932	T11	26.2	26.2	26.2	26.2	26.2	40	43	45	49	51	Yes
R208	4.5	Residence	422845	5089639	1972	T11	26.1	26.1	26.1	26.1	26.1	40	43	45	49	51	Yes
R209	4.5	Residence	422845	5089691	2023	T11	26.5	26.5	26.5	26.5	26.5	40	43	45	49	51	Yes
R210	4.5	Residence	422846	5089739	2070	T11	26.4	26.4	26.4	26.4	26.4	40	43	45	49	51	Yes
R211	4.5	Residence	422844	5089791	2122	T11	26.2	26.2	26.2	26.2	26.2	40	43	45	49	51	Yes
R212	4.5	Residence	422845	5089844	2174	T11	26.1	26.1	26.1	26.1	26.1	40	43	45	49	51	Yes
R213	4.5	Residence	422892	5089867	2191	T11	26.5	26.5	26.5	26.5	26.5	40	43	45	49	51	Yes
R214	4.5	Residence	422889	5089810	2135	T11	26.3	26.3	26.3	26.3	26.3	40	43	45	49	51	Yes
R215	4.5	Residence	422890	5089736	2061	T11	26.5	26.5	26.5	26.5	26.5	40	43	45	49	51	Yes
R216	4.5	Residence	422890	5089639	1965	T11	26.2	26.2	26.2	26.2	26.2	40	43	45	49	51	Yes
R217	4.5	Residence	422890	5089639	1965	T11	26.2	26.2	26.2	26.2	26.2	40	43	45	49	51	Yes
R218	4.5	Residence	422890	5089590	1916	T11	26.3	26.3	26.3	26.3	26.3	40	43	45	49	51	Yes
R219	4.5	Residence	422889	5089547	1874	T11	25.8	25.8	25.8	25.8	25.8	40	43	45	49	51	Yes
R220	4.5	Residence	422948	5089552	1871	T11	25.9	25.9	25.9	25.9	25.9	40	43	45	49	51	Yes
R221	4.5	Residence	422946	5089602	1921	T11	26.5	26.5	26.5	26.5	26.5	40	43	45	49	51	Yes
R222	4.5	Residence	422948	5089653	1972	T11	26.5	26.5	26.5	26.5	26.5	40	43	45	49	51	Yes
R223	4.5	Residence	422948	5089704	2023	T11	26.7	26.7	26.7	26.7	26.7	40	43	45	49	51	Yes
R224	4.5	Residence	422948	5089749	2067	T11	26.6	26.6	26.6	26.6	26.6	40	43	45	49	51	Yes
R225	4.5	Residence	422948	5089815	2133	T11	26.4	26.4	26.4	26.4	26.4	40	43	45	49	51	Yes

Point of Reception ID	Receptor Height [m]	Receptor Description			Distance to nearest Turbine [m]	Turbine ID	Calculated Sound Pressure Level [dBA] at Selected Windspeed [m/s]					Sound Level Limit [dBA] at Selected Windspeed [m/s]					Compliance with Limit [Yes/No]
			Easting	Northing			<=6	7	8	9	10	<=6	7	8	9	10	
R226	4.5	Residence	422951	5089869	2187	T11	26.6	26.6	26.6	26.6	26.6	40	43	45	49	51	Yes
R227	4.5	Residence	422995	5089931	2245	T11	27.1	27.1	27.1	27.1	27.1	40	43	45	49	51	Yes
R228	4.5	Residence	422932	5089974	2293	T11	26.9	26.9	26.9	26.9	26.9	40	43	45	49	51	Yes
R229	4.5	Residence	423145	5090030	2321	T14	27.2	27.2	27.2	27.2	27.2	40	43	45	49	51	Yes
R230	4.5	Residence	423146	5090090	2377	T14	27.1	27.1	27.1	27.1	27.1	40	43	45	49	51	Yes
R231	4.5	Residence	423191	5090099	2369	T14	27.8	27.8	27.8	27.8	27.8	40	43	45	49	51	Yes
R232	4.5	Residence	423219	5090091	2352	T14	27.9	27.9	27.9	27.9	27.9	40	43	45	49	51	Yes
R233	4.5	Residence	423271	5090090	2334	T14	27.9	27.9	27.9	27.9	27.9	40	43	45	49	51	Yes
R234	4.5	Residence	423351	5090090	2310	T14	28.0	28.0	28.0	28.0	28.0	40	43	45	49	51	Yes
R235	4.5	Residence	423309	5090243	2469	T14	27.6	27.6	27.6	27.6	27.6	40	43	45	49	51	Yes
R236	4.5	Residence	423340	5090227	2445	T14	27.8	27.8	27.8	27.8	27.8	40	43	45	49	51	Yes
R237	4.5	Residence	423365	5090198	2411	T14	27.9	27.9	27.9	27.9	27.9	40	43	45	49	51	Yes
R238	4.5	Residence	423343	5090178	2397	T14	27.9	27.9	27.9	27.9	27.9	40	43	45	49	51	Yes
R239	4.5	Residence	423451	5090198	2389	T14	28.1	28.1	28.1	28.1	28.1	40	43	45	49	51	Yes
R240	4.5	Residence	423498	5090196	2377	T14	28.2	28.2	28.2	28.2	28.2	40	43	45	49	51	Yes
R241	4.5	Residence	423572	5090189	2355	T14	28.4	28.4	28.4	28.4	28.4	40	43	45	49	51	Yes
R242	4.5	Residence	423672	5090170	2283	T06	28.6	28.6	28.6	28.6	28.6	40	43	45	49	51	Yes
R243	4.5	Residence	423723	5090202	2267	T06	28.6	28.6	28.6	28.6	28.6	40	43	45	49	51	Yes
R244	4.5	Residence	423707	5090089	2203	T06	29.0	29.0	29.0	29.0	29.0	40	43	45	49	51	Yes
R245	4.5	Residence	423552	5089992	2166	T14	28.8	28.8	28.8	28.8	28.8	40	43	45	49	51	Yes
R246	4.5	Residence	423828	5090048	2086	T06	29.4	29.4	29.4	29.4	29.4	40	43	45	49	51	Yes
R247	4.5	Residence	423935	5090074	2026	T06	29.7	29.7	29.7	29.7	29.7	40	43	45	49	51	Yes
R248	4.5	Residence	423960	5090021	1971	T06	30.1	30.1	30.1	30.1	30.1	40	43	45	49	51	Yes
R249	4.5	Residence	424053	5089936	1845	T06	30.5	30.5	30.5	30.5	30.5	40	43	45	49	51	Yes
R250	4.5	Residence	423953	5089829	1848	T06	30.8	30.8	30.8	30.8	30.8	40	43	45	49	51	Yes
R251	4.5	Residence	424006	5090163	2041	T06	29.5	29.5	29.5	29.5	29.5	40	43	45	49	51	Yes
R252	4.5	Residence	424053	5090175	2019	T06	29.6	29.6	29.6	29.6	29.6	40	43	45	49	51	Yes
R253	4.5	Residence	424051	5090082	1951	T06	29.9	29.9	29.9	29.9	29.9	40	43	45	49	51	Yes
R254	4.5	Residence	424114	5090178	1982	T06	29.7	29.7	29.7	29.7	29.7	40	43	45	49	51	Yes
R255	4.5	Residence	424124	5090094	1911	T06	30.0	30.0	30.0	30.0	30.0	40	43	45	49	51	Yes
R256	4.5	Residence	424562	5090170	1725	T06	29.9	29.9	29.9	29.9	29.9	40	43	45	49	51	Yes
R257	4.5	Residence	424572	5090066	1629	T06	30.7	30.7	30.7	30.7	30.7	40	43	45	49	51	Yes
R258	4.5	Residence	424757	5090092	1570	T06	30.7	30.7	30.7	30.7	30.7	40	43	45	49	51	Yes
R259	4.5	Residence	424854	5090155	1594	T06	30.5	30.5	30.5	30.5	30.5	40	43	45	49	51	Yes
R260	4.5	Residence	424251	5089057	1195	T06	34.0	34.0	34.0	34.0	34.0	40	43	45	49	51	Yes
R261	4.5	Residence	425766	5090096	1245	T05	31.6	31.6	31.6	31.6	31.6	40	43	45	49	51	Yes
R262	4.5	Residence	426208	5090025	1183	T05	28.1	28.1	28.1	28.1	28.1	40	43	45	49	51	Yes
R263	4.5	Residence	426302	5090035	1215	T05	27.9	27.9	27.9	27.9	27.9	40	43	45	49	51	Yes
R264	4.5	Residence	426427	5090016	1238	T05	27.8	27.8	27.8	27.8	27.8	40	43	45	49	51	Yes
R265	4.5	Residence	426470	5090076	1309	T05	27.3	27.3	27.3	27.3	27.3	40	43	45	49	51	Yes
R266	4.5	Residence	426400	5090220	1421	T05	29.1	29.1	29.1	29.1	29.1	40	43	45	49	51	Yes
R267	4.5	Residence	426654	5090101	1412	T05	26.8	26.8	26.8	26.8	26.8	40	43	45	49	51	Yes
R268	4.5	Residence	426803	5089870	1306	T05	27.7	27.7	27.7	27.7	27.7	40	43	45	49	51	Yes
R269	4.5	Residence	426680	5089805	1178	T05	28.5	28.5	28.5	28.5	28.5	40	43	45	49	51	Yes
R270	4.5	Residence	426571	5089815	1124	T05	28.7	28.7	28.7	28.7	28.7	40	43	45	49	51	Yes

Point of Reception ID	Receptor Height [m]	Receptor Description			Distance to nearest Turbine [m]	Turbine ID	Calculated Sound Pressure Level [dBA] at Selected Windspeed [m/s]					Sound Level Limit [dBA] at Selected Windspeed [m/s]					Compliance with Limit [Yes/No]
			Easting	Northing			<=6	7	8	9	10	<=6	7	8	9	10	
R271	4.5	Residence	426605	5089636	999	T05	29.8	29.8	29.8	29.8	29.8	40	43	45	49	51	Yes
R272	4.5	Residence	426686	5090278	1584	T05	28.0	28.0	28.0	28.0	28.0	40	43	45	49	51	Yes
R273	4.5	Residence	426560	5090519	1755	T05	28.8	28.8	28.8	28.8	28.8	40	43	45	49	51	Yes
R274	4.5	Residence	426669	5090525	1800	T05	28.6	28.6	28.6	28.6	28.6	40	43	45	49	51	Yes
R275	4.5	Residence	426494	5090859	2061	T05	28.1	28.1	28.1	28.1	28.1	40	43	45	49	51	Yes
R276	4.5	Residence	427119	5091071	2487	T05	26.6	26.6	26.6	26.6	26.6	40	43	45	49	51	Yes
R277	4.5	Residence	427330	5091149	2658	T05	26.4	26.4	26.4	26.4	26.4	40	43	45	49	51	Yes
R278	4.5	Residence	427400	5091255	2785	T05	25.9	25.9	25.9	25.9	25.9	40	43	45	49	51	Yes
R279	4.5	Residence	427452	5091277	2831	T05	25.8	25.8	25.8	25.8	25.8	40	43	45	49	51	Yes
R280	4.5	Residence	427503	5091292	2871	T05	25.6	25.6	25.6	25.6	25.6	40	43	45	49	51	Yes
R281	4.5	Residence	422388	5085974	703	T23	38.9	38.9	38.9	38.9	38.9	40	43	45	49	51	Yes
R282	4.5	Residence	423985	5086985	889	T14	38.8	38.8	38.8	38.8	38.8	40	43	45	49	51	Yes
R283	4.5	Residence	426527	5090176	1424	T05	26.7	26.7	26.7	26.7	26.7	40	43	45	49	51	Yes
R284	4.5	Residence	426010	5090024	1158	T05	31.1	31.1	31.1	31.1	31.1	40	43	45	49	51	Yes
R285	4.5	Residence	424926	5090047	1469	T06	31.2	31.2	31.2	31.2	31.2	40	43	45	49	51	Yes
R286	4.5	Residence	424200	5089019	1161	T14	34.0	34.0	34.0	34.0	34.0	40	43	45	49	51	Yes
R287	4.5	Residence	427148	5087039	850	T15	36.4	36.4	36.4	36.4	36.4	40	43	45	49	51	Yes
R288	4.5	Residence	425189	5087124	749	T20	39.9	39.9	39.9	39.9	39.9	40	43	45	49	51	Yes
R289	4.5	Residence	423357	5087054	669	T11	40.0	40.0	40.0	40.0	40.0	40	43	45	49	51	Yes
R290	4.5	Residence	422517	5087064	895	T11	37.5	37.5	37.5	37.5	37.5	40	43	45	49	51	Yes
R291	4.5	Residence	422500	5087404	716	T11	37.4	37.4	37.4	37.4	37.4	40	43	45	49	51	Yes
R292	4.5	Residence	425210	5083512	1435	T34	32.5	32.5	32.5	32.5	32.5	40	43	45	49	51	Yes
R293	4.5	Residence	414364	5084702	1367	T25	32.2	32.2	32.2	32.2	32.2	40	43	45	49	51	Yes
R294	4.5	Residence	417895	5087741	3363	T21	17.2	17.2	17.2	17.2	17.2	40	43	45	49	51	Yes
R295	4.5	Residence	420407	5088789	2402	T17	21.2	21.2	21.2	21.2	21.2	40	43	45	49	51	Yes
R296	4.5	Residence	422517	5086964	822	T18	37.7	37.7	37.7	37.7	37.7	40	43	45	49	51	Yes
R297	4.5	Residence	424447	5086782	910	T20	38.3	38.3	38.3	38.3	38.3	40	43	45	49	51	Yes
V201	4.5	Vacant Lot	416111	5085448	916	T25	34.0	34.0	34.0	34.0	34.0	40	43	45	49	51	Yes
V202	4.5	Vacant Lot	415772	5085228	614	T25	37.1	37.1	37.1	37.1	37.1	40	43	45	49	51	Yes
V203	4.5	Vacant Lot	415560	5085236	644	T25	36.7	36.7	36.7	36.7	36.7	40	43	45	49	51	Yes
V204	4.5	Vacant Lot	416378	5085236	898	T25	34.5	34.5	34.5	34.5	34.5	40	43	45	49	51	Yes
V205	4.5	Vacant Lot	416543	5085041	919	T25	34.8	34.8	34.8	34.8	34.8	40	43	45	49	51	Yes
V206	4.5	Vacant Lot	416530	5084775	817	T25	36.2	36.2	36.2	36.2	36.2	40	43	45	49	51	Yes
V207	4.5	Vacant Lot	416522	5084529	797	T25	37.3	37.3	37.3	37.3	37.3	40	43	45	49	51	Yes
V208	4.5	Vacant Lot	416526	5084309	831	T36	38.2	38.2	38.2	38.2	38.2	40	43	45	49	51	Yes
V209	4.5	Vacant Lot	416531	5084090	642	T36	39.4	39.4	39.4	39.4	39.4	40	43	45	49	51	Yes
V210	4.5	Vacant Lot	417174	5083754	1013	T36	36.7	36.7	36.7	36.7	36.7	40	43	45	49	51	Yes
V211	4.5	Vacant Lot	417314	5083750	1150	T36	35.9	35.9	35.9	35.9	35.9	40	43	45	49	51	Yes
V212	4.5	Vacant Lot	417746	5083584	1248	T39	34.2	34.2	34.2	34.2	34.2	40	43	45	49	51	Yes
V213	4.5	Vacant Lot	415097	5084087	621	T35	39.1	39.1	39.1	39.1	39.1	40	43	45	49	51	Yes
V214	4.5	Vacant Lot	414878	5084087	827	T35	37.1	37.1	37.1	37.1	37.1	40	43	45	49	51	Yes
V215	4.5	Vacant Lot	414878	5083745	796	T35	37.8	37.8	37.8	37.8	37.8	40	43	45	49	51	Yes
V216	4.5	Vacant Lot	414857	5083473	867	T38	38.0	38.0	38.0	38.0	38.0	40	43	45	49	51	Yes
V217	4.5	Vacant Lot	417808	5082187	786	T39	36.1	36.1	36.1	36.1	36.1	40	43	45	49	51	Yes
V218	4.5	Vacant Lot	415257	5081810	870	T42	36.3	36.3	36.3	36.3	36.3	40	43	45	49	51	Yes

Point of Reception ID	Receptor Height [m]	Receptor Description		Distance to nearest Turbine [m]	Turbine ID	Calculated Sound Pressure Level [dBA] at Selected Windspeed [m/s]					Sound Level Limit [dBA] at Selected Windspeed [m/s]					Compliance with Limit [Yes/No]	
			Easting			Northing	<=6	7	8	9	10	<=6	7	8	9		10
V219	4.5	Vacant Lot	415663	5081506	1162	T31	35.5	35.5	35.5	35.5	35.5	40	43	45	49	51	Yes
V220	4.5	Vacant Lot	416293	5081191	1051	T43	34.6	34.6	34.6	34.6	34.6	40	43	45	49	51	Yes
V221	4.5	Vacant Lot	416719	5081207	974	T43	34.8	34.8	34.8	34.8	34.8	40	43	45	49	51	Yes
V222	4.5	Vacant Lot	417104	5081186	1090	T43	34.0	34.0	34.0	34.0	34.0	40	43	45	49	51	Yes
V223	4.5	Vacant Lot	417509	5081170	1323	T43	32.6	32.6	32.6	32.6	32.6	40	43	45	49	51	Yes
V224	4.5	Vacant Lot	419978	5085151	1354	T21	31.3	31.3	31.3	31.3	31.3	40	43	45	49	51	Yes
V225	4.5	Vacant Lot	420615	5085171	1031	T21	33.4	33.4	33.4	33.4	33.4	40	43	45	49	51	Yes
V226	4.5	Vacant Lot	421208	5085154	1071	T21	33.8	33.8	33.8	33.8	33.8	40	43	45	49	51	Yes
V227	4.5	Vacant Lot	420433	5085569	742	T21	35.7	35.7	35.7	35.7	35.7	40	43	45	49	51	Yes
V228	4.5	Vacant Lot	420419	5087052	920	T17	34.8	34.8	34.8	34.8	34.8	40	43	45	49	51	Yes
V229	4.5	Vacant Lot	421390	5087021	562	T17	38.4	38.4	38.4	38.4	38.4	40	43	45	49	51	Yes
V230	4.5	Vacant Lot	422068	5086978	1022	T17	36.3	36.3	36.3	36.3	36.3	40	43	45	49	51	Yes
V231	4.5	Vacant Lot	420597	5087265	943	T17	34.3	34.3	34.3	34.3	34.3	40	43	45	49	51	Yes
V232	4.5	Vacant Lot	421205	5087247	741	T17	36.2	36.2	36.2	36.2	36.2	40	43	45	49	51	Yes
V233	4.5	Vacant Lot	421420	5087234	771	T17	36.1	36.1	36.1	36.1	36.1	40	43	45	49	51	Yes
V234	4.5	Vacant Lot	421881	5087794	1278	T11	33.8	33.8	33.8	33.8	33.8	40	43	45	49	51	Yes
V235	4.5	Vacant Lot	422617	5087216	719	T11	38.0	38.0	38.0	38.0	38.0	40	43	45	49	51	Yes
V236	4.5	Vacant Lot	423052	5088985	1297	T11	33.4	33.4	33.4	33.4	33.4	40	43	45	49	51	Yes
V237	4.5	Vacant Lot	427368	5089192	937	T09	34.2	34.2	34.2	34.2	34.2	40	43	45	49	51	Yes
V238	4.5	Vacant Lot	427775	5089185	1168	T09	31.6	31.6	31.6	31.6	31.6	40	43	45	49	51	Yes
V239	4.5	Vacant Lot	427385	5088950	736	T09	35.7	35.7	35.7	35.7	35.7	40	43	45	49	51	Yes
V240	4.5	Vacant Lot	426953	5087112	660	T15	38.1	38.1	38.1	38.1	38.1	40	43	45	49	51	Yes
V241	4.5	Vacant Lot	426719	5086974	664	T15	38.5	38.5	38.5	38.5	38.5	40	43	45	49	51	Yes
V242	4.5	Vacant Lot	426443	5085121	1309	T19	33.4	33.4	33.4	33.4	33.4	40	43	45	49	51	Yes
V243	4.5	Vacant Lot	426058	5085116	1239	T19	34.7	34.7	34.7	34.7	34.7	40	43	45	49	51	Yes
V244	4.5	Vacant Lot	425429	5085108	706	T28	38.0	38.0	38.0	38.0	38.0	40	43	45	49	51	Yes
V245	4.5	Vacant Lot	425439	5084988	699	T28	37.8	37.8	37.8	37.8	37.8	40	43	45	49	51	Yes
V246	4.5	Vacant Lot	426457	5084691	1724	T19	32.2	32.2	32.2	32.2	32.2	40	43	45	49	51	Yes
V247	4.5	Vacant Lot	425270	5084096	999	T28	35.1	35.1	35.1	35.1	35.1	40	43	45	49	51	Yes
V248	4.5	Vacant Lot	423904	5083118	1119	T34	33.1	33.1	33.1	33.1	33.1	40	43	45	49	51	Yes
V249	4.5	Vacant Lot	423503	5083074	1252	T34	32.5	32.5	32.5	32.5	32.5	40	43	45	49	51	Yes



M1 Manitoulin Island Wind Farm
Key Plan

50 Ronson Drive Suite 165, Toronto, Canada M9W 1B3 T. 416 249 3361

Drawn:
BS

Eng:
PA

Drawing:
Key Plan

Date:
June 30, 2011

Scale:
NTS

Fig:
1

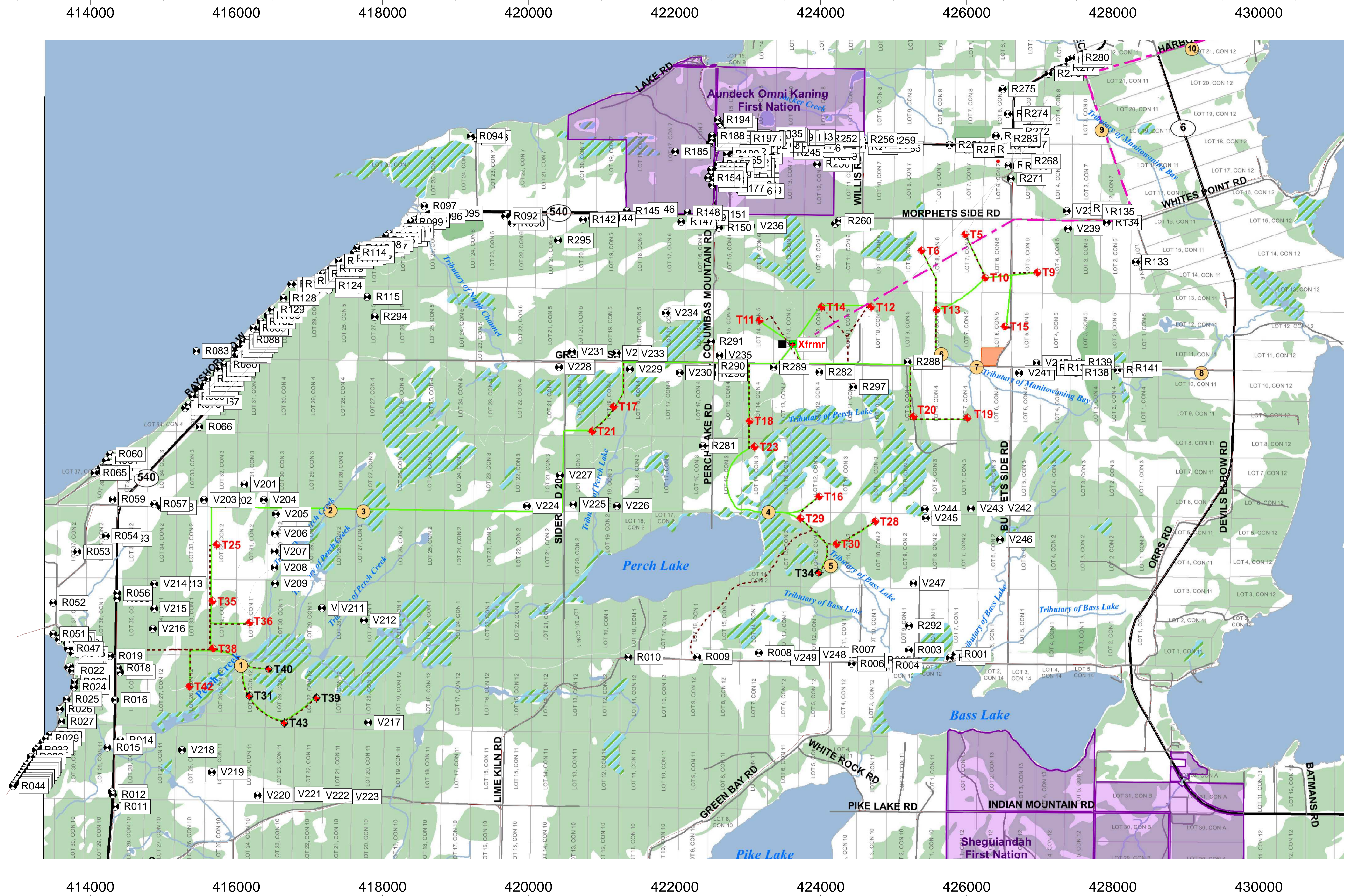

M1 Manitoulin Island Wind Farm
 Turbine, Transformer, and Receptor Layout
 GE 2.5-103 Turbines

50 Ronson Drive Suite 165, Toronto, Canada M9W 1B3 T. 416 249 3361

Drawn: BS Eng: PA Drawing: Turbine, Transformer, and Receptor Layout

Date: June 30, 2011 Scale: 1:25,000 if printed on A1

Fig: 2

Figure 3 - Transformer Dimensions

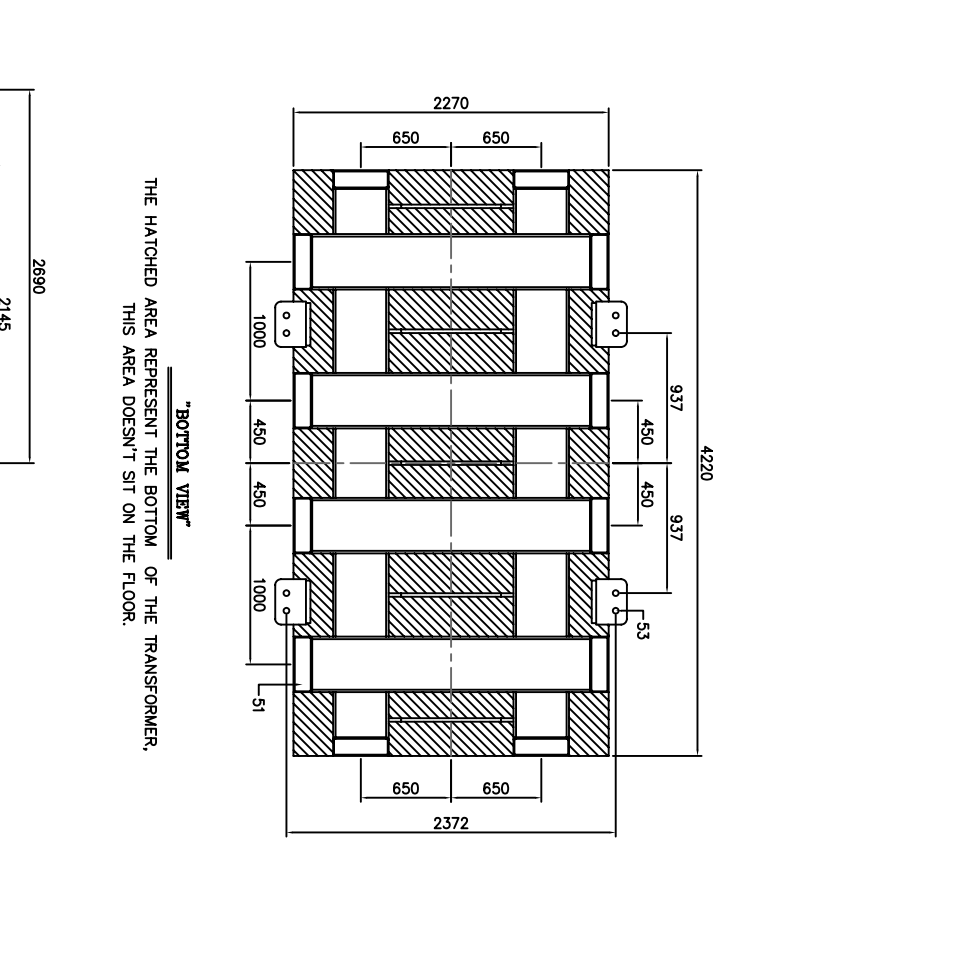
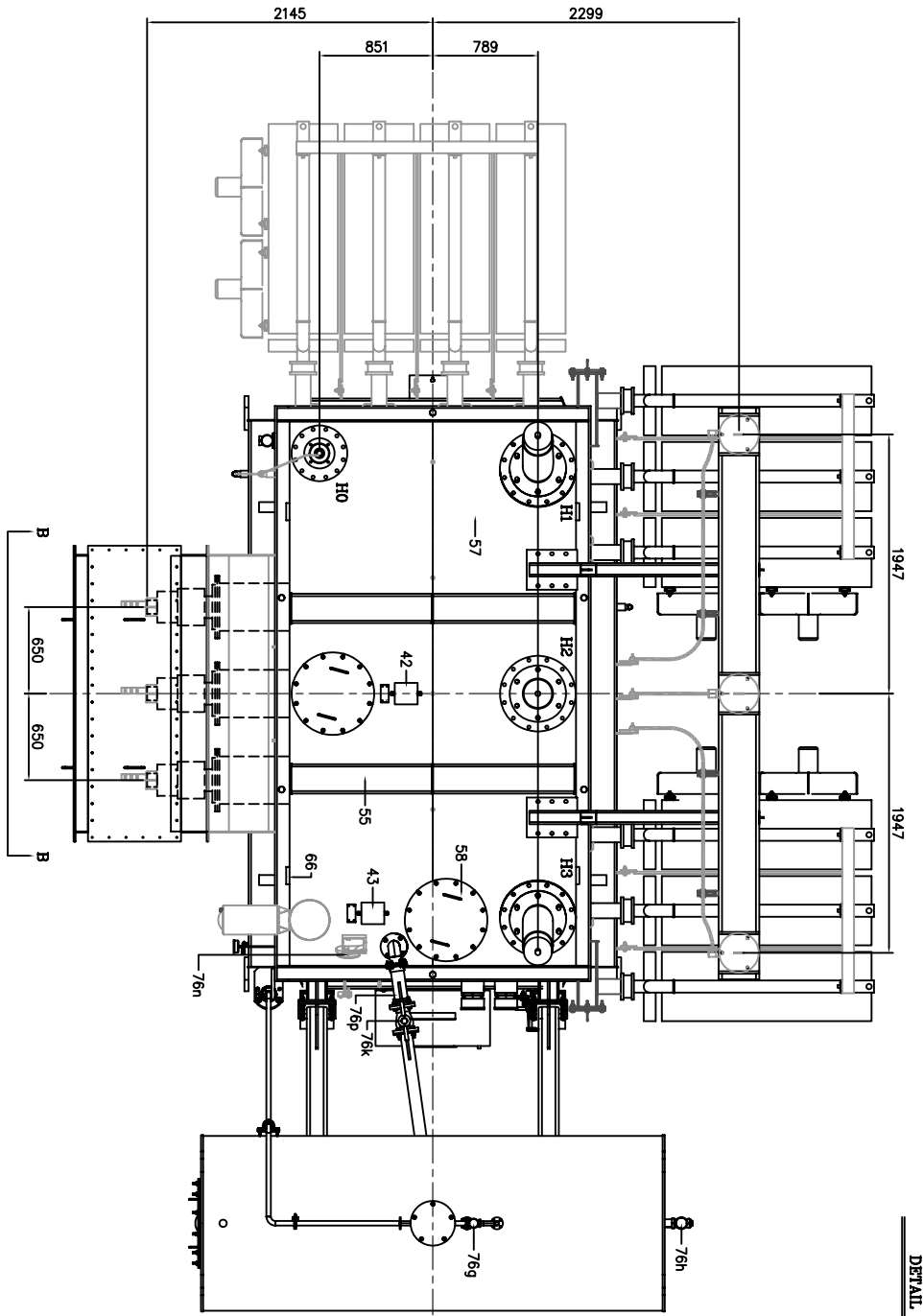
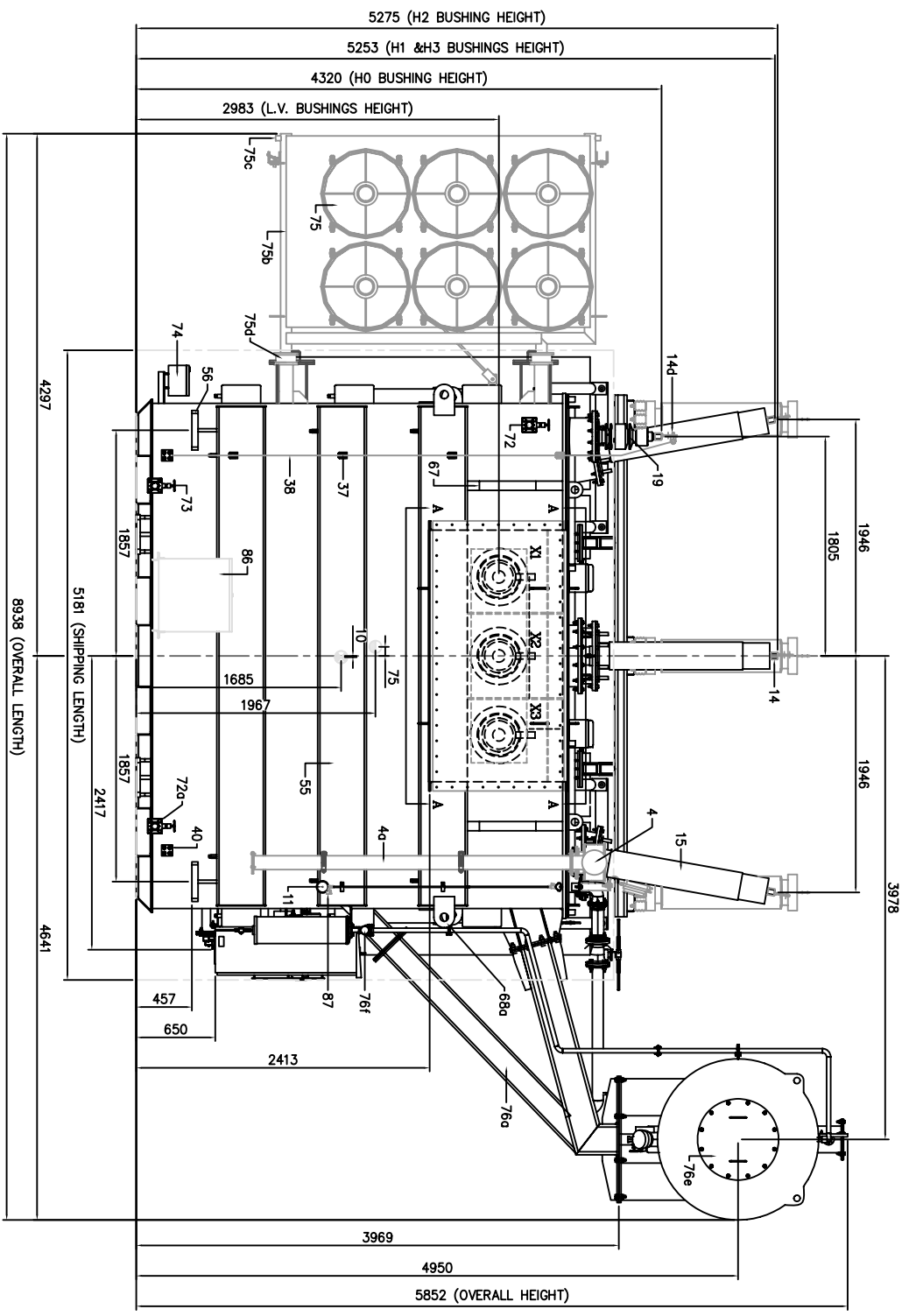

"BOTTOM VIEW"
 THE HATCHED AREA REPRESENT THE BOTTOM OF THE TRANSFORMER.
 THIS AREA DOESN'T SIT ON THE FLOOR.

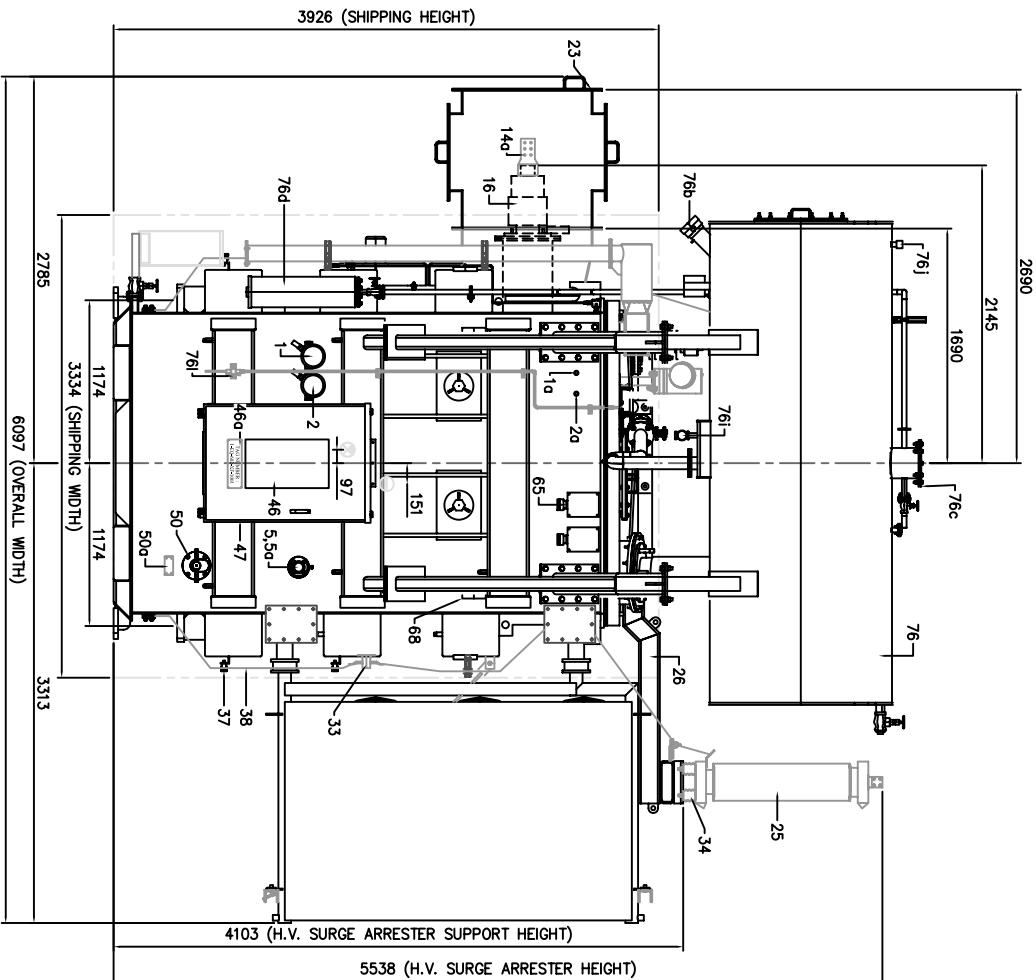

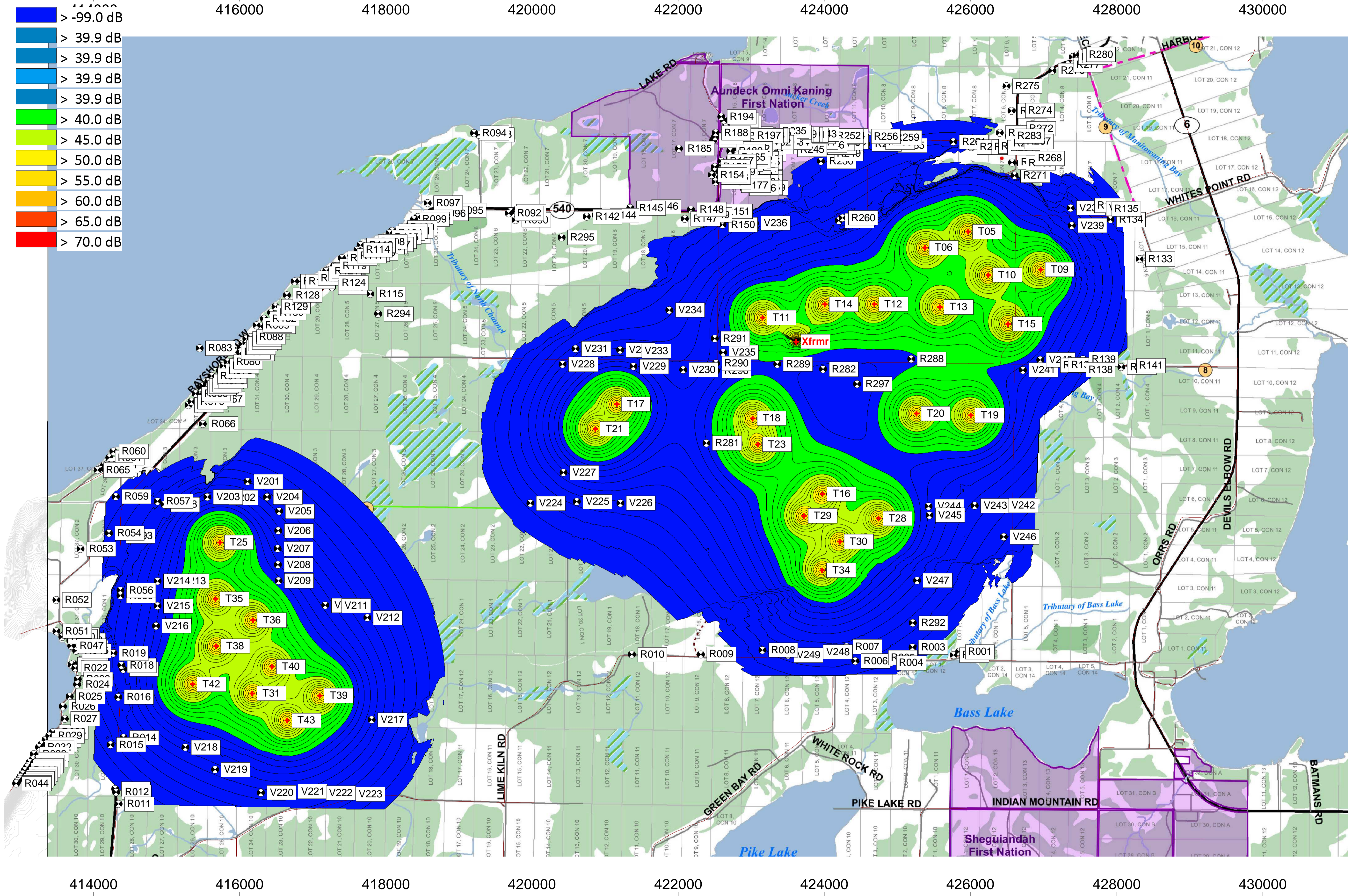
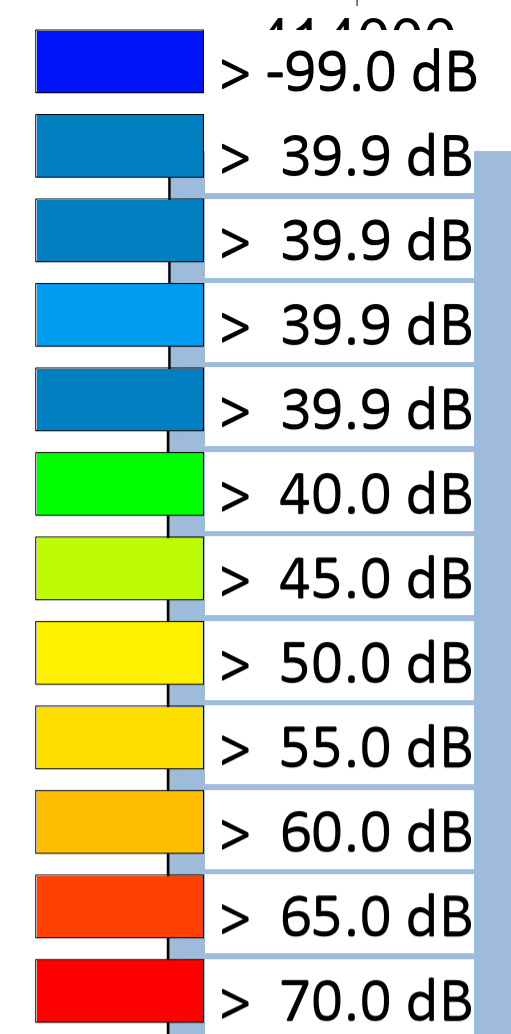

M1 Manitoulin Island Wind Farm
 Noise Contour (4.5m high grid)
 GE 2.5-103 Turbines

Windspeed: 6m/s Wind Shear = 0.435

50 Ronson Drive Suite 165, Toronto, Canada M9W 1B3 T. 416 249 3361

Drawn:
BS

Eng:
PA

Drawing:
Noise Contour (4.5m high grid)

Date:
June 30, 2011

Scale:
1:25,000 if printed on A1

Fig:
5

ATTACHMENT A

REPRINT OF MOE PUBLICATION, OCTOBER 2008

NOISE GUIDELINES FOR WIND FARMS
INTERPRETATION FOR APPLYING MOE NPC
PUBLICATIONS TO
WIND POWER GENERATION FACILITIES

Noise Guidelines for Wind Farms

Interpretation for Applying MOE NPC Publications to
Wind Power Generation Facilities

Ministry of the Environment



October 2008

© Queen's Printer for Ontario, 2008

PIBS 4709e

NOISE GUIDELINES FOR WIND FARMS

Interpretation for Applying MOE NPC Publications to Wind Power Generation Facilities

October 2008

This document establishes the sound level limits for land-based wind power generating facilities and describes the information required for noise assessments and submissions under the Environmental Assessment Act and the Environmental Protection Act. It replaces the document "Interpretation for Applying MOE NPC Technical Publications to Wind Turbine Generators," Version 1.0, July 6, 2004.

Table of Contents

1.	SCOPE	3
2.	REFERENCES	3
3.	DEFINITIONS	3
4.	DESCRIPTION OF WIND FARM NOISE.....	5
5.	SOUND LEVEL LIMITS FOR WIND FARMS.....	5
5.1	Limits for Wind Turbine Generators	5
5.2	Limits for Wind Turbine Generators and Transformer Substations.....	7
5.3	Limits for Transformer Substations.....	7
6.	NOISE ASSESSMENT REPORT	7
6.1	Project Layout.....	7
6.2	Noise Sources	8
6.2.1	Description.....	8
6.2.2	Wind Turbines	8
6.2.3	Adjustment to Wind Turbine Generator Acoustic Emissions for Wind Speed Profile ..	9
6.2.4	Transformer Substation	9
6.2.5	Noise Sources and Locations.....	9
6.3	Receptors	9
6.3.1	Wind Farm Does Not Include Transformer Substation	10
6.3.2	Wind Farm Includes Transformer Substation.....	10
6.3.3	Vacant Lots.....	10
6.3.4	Area Classification of Receptors	11
6.3.5	Receptors and Locations.....	11
6.4	Detailed Noise Impact Assessment.....	11
6.4.1	Distance Requirement.....	11
6.4.2	Whole Wind Farm Assessment	12
6.4.3	Transformer Substation Assessment	12
6.4.4	Impact of Adjacent Approved Wind Farms.....	12
6.4.5	Impact of Adjacent Wind Farms in the Process of Being Planned.....	12
6.4.6	Assessment of Participating Receptors.....	13
6.4.7	Prediction Method.....	13
6.4.8	Adjustment for Special Quality of Sound.....	13
6.4.9	Sound Level Contributions from Distant Wind Turbine Generators	13
6.4.10	Specific Parameters	14
6.5	Results and Compliance.....	14
6.5.1	Presentation of Results	14
6.5.2	Assessment of Compliance	15

6.6	Summary Tables	15
6.6.1	Wind Turbine Acoustic Emissions Summary Table	15
6.6.2	Locations of Wind Turbine Generators, Transformer Substations and Receptors	16
6.6.3	Noise Impact Assessment Summary Tables.....	17
6.7	Appendices	18

TABLES

Table 1	Summary of Sound Level Limits for Wind Turbines	6
Table 2	Atmospheric Absorption Coefficients	14
Table 3	Wind Turbine Acoustic Emissions Summary.....	15
Table 4	Wind Turbine Locations.....	16
Table 5	Point of Reception Locations.....	16
Table 6	Participating Receptor Locations.....	16
Table 7	Combined Noise Impact Summary – Points of Reception	17
Table 8	Combined Noise Impact Summary – Participating Receptors	17
Table 9	Wind Turbine Noise Impact Summary – Points of Reception	17
Table 10	Wind Turbine Noise Impact Summary – Participating Receptors	18
Table 11	Transformer Substation Noise Impact Summary – Points of Reception.....	18
Table 12	Transformer Substation Noise Impact Summary – Participating Receptors.....	18

FIGURE

Figure 1	Summary of Sound Level Limits for Wind Turbines	6
----------	-------------------------------------------------------	---

1. SCOPE

Noise impacts of proposed land-based wind power generation facilities, i.e. Wind Farms, are considered in the course of assessing an application for a Certificate of Approval (Air/Noise), in accordance with section 9 of the *Environmental Protection Act*. Wind Farms two megawatts or more are subject to review under the Environmental Screening Process, in accordance with Ontario Regulation 116/01 under the *Environmental Assessment Act*, and noise impacts are also considered during review under the screening process. The purpose of this document is to describe the applicable sound level limits and to specify the information proponents are to submit to the Ministry of the Environment when seeking approval for a proposed land-based Wind Farm. This document has been developed to provide consistency in the submissions and to streamline the review and approval process. Accordingly, the guidance contained herein is intended to provide uniformity in planning of Wind Farms in Ontario.

Proponents of Wind Farms are to prepare and submit to the Ministry of the Environment (MOE) a Noise Assessment Report that includes details of the wind turbine design and operation, location of the wind turbine(s) within the specific site and surrounding area, as well as summary of compliance with the applicable sound level limits. If applicable, the Noise Assessment Report must also include similar details of the Transformer Substation used for transforming the power from the wind turbine units. This document defines a template for the Noise Assessment Report to be submitted to the MOE.

This document also provides guidance on the assessment of the combined noise impact produced by the proposed Wind Farm in combination with the noise impact of approved Wind Farms or Wind Farms that are in the process of being planned.

2. REFERENCES

Reference is made to the following publications:

- [1] NPC-104, "Sound Level Adjustments," Ontario Ministry of the Environment
- [2] NPC-205, "Sound Level Limits for Stationary Sources in Class 1 & 2 Areas (Urban)," Ontario Ministry of the Environment
- [3] NPC-206, "Sound Levels due to Road Traffic," Ontario Ministry of the Environment
- [4] NPC-232, "Sound Level Limits for Stationary Sources in Class 3 Areas (Rural)," Ontario Ministry of the Environment
- [5] CAN/CSA-C61400-11-07, "Wind Turbine Generator Systems - Part 11: Acoustic Noise Measurement Techniques"
- [6] ISO 9613-2, "Acoustics-Attenuation of sound during propagation outdoors - Part 2: General method of calculation"
- [7] ANSI/IEEE C57.12.90, "Distribution, Power, and Regulating Transformers"

3. DEFINITIONS

For the purpose of this document, the following definitions apply:

"Environmental Screening Process" is a prescribed planning process for electricity projects set out in Part B of the Guide to Environmental Assessment Requirements for Electricity Projects. As set out in Ontario Regulation 116/01 under the *Environmental Assessment Act*, certain electricity projects are subject to review under the Environmental Screening Process.

“Noise Assessment Report” means a report for wind power electricity generation projects, prepared in accordance with the guidance described in this document.

“Participating Receptor” means a property that is associated with the Wind Farm by means of a legal agreement with the property owner for the installation and operation of wind turbines or related equipment located on that property.

“Switching Station” means a collection point for the outputs of the wind turbine generators. Switching Stations are not significant noise sources.

“Transformer Substation” means a central facility comprised of power transformer(s) and associated equipment such as cooling fans for transforming the electrical outputs from the wind turbine generators to a higher voltage for input to the grid transmission system. Transformer Substations are significant noise sources.

“Wind Farm” means an electrical generating facility comprised of an array of wind turbine generators and a common electrical connection point such as a Transformer Substation or a Switching Station.

The following definitions are also included in the current Publications NPC-205 and NPC-232, References [2] and [4]:

“Class 1 Area” means an area with an acoustical environment typical of a major population centre, where the background noise is dominated by the urban hum.

“Class 2 Area” means an area with an acoustical environment that has qualities representative of both Class 1 and Class 3 Areas, and in which a low ambient sound level, normally occurring only between 23:00 and 07:00 hours in Class 1 Areas, will typically be realized as early as 19:00 hours.

Other characteristics which may indicate the presence of a Class 2 Area include:

- i. absence of urban hum between 19:00 and 23:00 hours;
- ii. evening background sound level defined by natural environment and infrequent human activity; and
- iii. no clearly audible sound from stationary sources other than from those under consideration.

“Class 3 Area” means a rural area with an acoustical environment that is dominated by natural sounds having little or no road traffic, such as the following:

- i. a small community with less than 1000 population;
- ii. agricultural area;
- iii. a rural recreational area such as a cottage or a resort area; or
- iv. a wilderness area.

The following definition is also included in the current Publication NPC-232, Reference [4]:

“Point of Reception” means any point on the premises of a person within 30 m of a dwelling or a camping area, where sound or vibration originating from other than those premises is received.

For the purpose of approval of new sources, including verifying compliance with section 9 of the *Environmental Protection Act*, the Point of Reception may be located on any of the following existing or zoned for future use premises: permanent or seasonal residences,

hotels/motels, nursing/retirement homes, rental residences, hospitals, camp grounds, and noise sensitive buildings such as schools and places of worship.

For equipment/facilities proposed on premises such as nursing/retirement homes, rental residences, hospitals, and schools, the Point of Reception may be located on the same premises.

4. DESCRIPTION OF WIND FARM NOISE

A Wind Farm is a collection of wind turbines, located in the same area, used for the production of electric power. As the individual wind turbines are separated by several hundred metres from each other, a large wind farm covers an area of tens of square kilometres. Larger Wind Farms may include a Transformer Substation that collects and increases the voltage produced by the turbines to the higher voltage for the grid transmission system.

A typical wind turbine consists of a tall tower with a hub (nacelle or housing) containing the drive-train and generator mounted on top of the tower. Three rotating blades (typically) are connected to a horizontal hub. In general, the significant noise sources associated with the operation of a Wind Farm are the wind turbines and the Transformer Substation. Noise from wind turbines consists of the aerodynamic noise caused by blades passing through the air, and mechanical noise created by the operation of mechanical elements of the drive-train. Close to the turbine, the noise typically exhibits a swishing sound as the blades rotate; and the whirr of the drive-train and generator. However, as distance from the turbine increases, these effects are reduced. The wind turbine noise perceived at receptors is typically broadband in nature. Any tonal character associated with the wind turbine noise is generally associated with maintenance issues.

The Transformer Substation noise is produced by the vibration of the transformer core and associated components, and by the operation of other equipment such as cooling fans. The noise produced by a Transformer Substation generally exhibits a pronounced hum, associated with the fundamental electrical frequency and its harmonics. Consequently, the Transformer Substation noise perceived at receptors is typically tonal.

The noise produced by wind turbines, as well as the background noise, typically increases with wind speed. The noise produced by a Transformer Substation is unaffected by the wind speed.

5. SOUND LEVEL LIMITS FOR WIND FARMS

5.1 Limits for Wind Turbine Generators

The sound level limits for wind turbines are set relative to the existing MOE Noise Guidelines in Publications NPC-205 and NPC-232, References [2] and [4], as well as to a reference wind induced background sound level. Consistent with these guidelines, the sound level limits, expressed in terms of the hourly, "A-weighted," equivalent sound level (L_{eq}), apply at Points of Reception.

a) Receptors in Class 1 & 2 Areas (Urban)

The sound level limits at a Point of Reception in Class 1 & 2 Areas (Urban) are given by the applicable values in Table 1 and Figure 1, or by the sound level limits, established in accordance with requirements in Publication NPC-205.

b) Receptors in Class 3 Areas (Rural)

The sound level limits at a Point of Reception in Class 3 Areas (Rural) are given by the applicable values in Table 1 and Figure 1, or by the sound level limits, established in accordance with requirements in Publication NPC-232.

The wind turbine sound level limits are given at integer values of the wind speed and are shown as the solid lines in Figure 1. The dashed line in Figure 1 does not represent a limit and is included only for information purposes¹. These sound level limits range from the lowest value of 40 dBA for Class 3 Areas and wind speeds at or below 4 m/s to the maximum value of 51 dBA for wind speeds at or above 10 m/s.

Table 1 Summary of Sound Level Limits for Wind Turbines

Wind Speed (m/s) at 10 m height	4	5	6	7	8	9	10
Wind Turbine Sound Level Limits Class 3 Area, dBA	40.0	40.0	40.0	43.0	45.0	49.0	51.0
Wind Turbine Sound Level Limits Class 1 & 2 Areas, dBA	45.0	45.0	45.0	45.0	45.0	49.0	51.0

Figure 1 Summary of Sound Level Limits for Wind Turbines

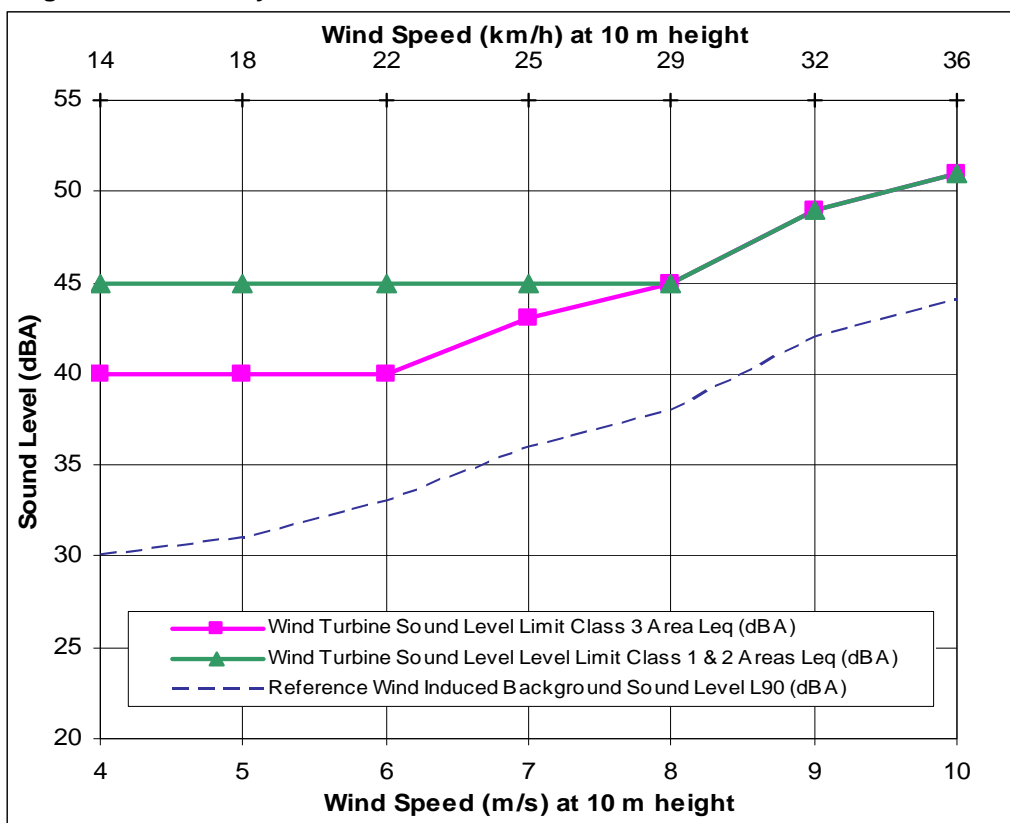

¹ The measurement of wind induced background sound level is not required to establish the applicable limit. The wind induced background sound level reference curve, dashed line in Figure 1, was determined by correlating the A-weighted ninetieth percentile sound level (L_{90}) with the average wind speed measured at a particularly quiet site. The applicable L_{eq} sound level limits at higher wind speeds are given by adding 7 dB to the wind induced background L_{90} sound level reference values, using the principles for establishing sound level limits described in Publication NPC-232, Reference [4].

5.2 Limits for Wind Turbine Generators and Transformer Substations

In cases where the noise impact at a Point of Reception is composed of combined contributions due to the Transformer Substation as well as the wind turbine generators, the applicable limits are those shown in Table 1 and Figure 1, as described in Section 5.1.

The combined noise impact must comply with the limits at all the wind speeds from 0 m/s to 10 m/s. It should be noted that the acoustic emissions from a Transformer Substation are independent and unrelated to the wind speed, unlike the acoustic emissions from wind turbine generators which are wind speed dependent.

In determining the combined impact, a 5 dB adjustment must be added to the Transformer Substation noise in accordance with Publication NPC-104, Reference [1].

5.3 Limits for Transformer Substations

In unique cases where the noise impact assessment at a Point of Reception is limited to the operation of the Transformer Substation, as in a case described in Section 6.4.1, the sound level limit at a Point of Reception is given in the Publication NPC-205, Reference [2] or Publication NPC-232, Reference [4], whichever is applicable. The limit is independent of wind induced noise.

In order to account for the tonal characteristics of Transformer Substation noise, a 5 dB adjustment must be added to the acoustic emissions in accordance with Publication NPC-104, Reference [1].

6. NOISE ASSESSMENT REPORT

A Noise Assessment Report must be prepared for all proposed Wind Farms. The requirements for a detailed noise impact assessment depend on the proximity of the Wind Farm to receptors and are described in Section 6.4. The report must be submitted in a hard copy as well as in an electronic format.

The Noise Assessment Report must demonstrate compliance with the applicable sound level limits and the supporting information must be organized in a clear and concise manner. The report must be prepared by a qualified acoustical consultant and the cover document must be signed by the proponent for the project.

The Noise Assessment Report should be performed early in the planning of the project, as part of the Environmental Screening Process. The expectation of the MOE is that the submitted Noise Assessment Report be complete and accurate. Results of the Noise Assessment Report should be included in the Screening Report or Environmental Review Report prepared under the Environmental Screening Process. Any revisions to the Noise Assessment Report following the completion of the Environmental Screening Process should be very limited and clearly identified. In cases where complete information about the Wind Farm (e.g., information relating the transformer equipment) was not available at the environmental screening stage, such information must be provided to the MOE with the application for the Certificate of Approval under section 9 of the *Environmental Protection Act* for the Wind Farm.

As a minimum, the report must include the following sections in the given sequence:

6.1 Project Layout

The overall plan of the Wind Farm must be described in detail for the purpose of supporting the noise impact assessment calculations and for demonstrating compliance with the sound level

limits. General project layout description must be supported with clear maps of the site and surrounding area, complete with scale, northing, and legend information. A suitable minimum drawing scale for the overall plan of the project is 1 cm : 500 m.

The following details must be included:

- a) Geographic location of the project study area;
- b) Locations of wind turbines;
- c) Location of Transformer Substation or Switching Station;
- d) Locations of all receptors including buildings, dwellings, campsites, places of worship, and institutions, up to 2000 m from any wind turbine location; and
- e) Property boundaries of lands associated with the project and location of dwellings therein.

The following additional information must be included, if applicable:

- f) Municipal zoning and land-use plans;
- g) Topographical features including roadways, terrain elevations, and ground cover; and
- h) Available information regarding the location and scope of other approved² Wind Farms, and Wind Farms in the process of being planned³, located within 5 km of any wind turbine generators of the proposed Wind Farm.

6.2 Noise Sources

For the purposes of this document, noise sources mean land-based wind turbine generators and Transformer Substations.

6.2.1 Description

The Noise Assessment Report must include the description of the wind turbine generators, including: manufacturer's make and model, maximum electrical output rating, hub height above grade, range of rotational speeds, and mode of operation.

The Noise Assessment Report must also include the description of the Transformer Substation, including all available information at the time of submission on the manufacturer's make and model designations, maximum electrical output rating, primary and secondary voltages, method of cooling, physical dimensions, drawing showing elevation and plan views of the unit, and any noise abatement measures.

Manufacturer's specifications should be included in an Appendix.

6.2.2 Wind Turbines

The acoustic emissions of the wind turbine must be specified by the manufacturer for the full range of rated operation and wind speeds. As a minimum, the information must include the sound power levels, frequency spectra in octave bands (63 to 8000 Hz), and tonality at integer

² For the purposes of this document, a Wind Farm is considered to be "approved" if a Certificate of Approval (Noise) under section 9 of the *Environmental Protection Act* has been issued.

³ For the purposes of this document, a Wind Farm is considered to be "in the process of being planned" if a Notice of Commencement has been issued for the project in accordance with the Environmental Screening Process prescribed under Ontario Regulation 116/01 under the *Environmental Assessment Act*, but for which a Certificate of Approval (Noise) under section 9 of the *Environmental Protection Act* has not yet been issued.

wind speeds from 6 to 10 m/s. The acoustic emission information must be determined and reported in accordance with the international standard CAN/CSA-C61400-11-07, Reference [5].

6.2.3 Adjustment to Wind Turbine Generator Acoustic Emissions for Wind Speed Profile

The wind speed profile on site of the Wind Farm may have an effect on the manufacturer's wind turbine acoustic emission data and, consequently, on the sound levels predicted at a Point of Reception. Therefore, the wind turbine generator acoustic emission levels must be consistent with the wind speed profile of the project area.

To address this issue, the assessment must use manufacturer's acoustic emission data adjusted for the average summer night time wind speed profile, representative of the site.

The adjusted acoustic emissions data must be used in the noise impact assessment at each receptor. The manufacturer's acoustic emissions data and the adjusted acoustic emission data used in the noise impact assessment must be tabulated in Table 3.

6.2.4 Transformer Substation

The acoustic emissions of each transformer unit must be specified by the manufacturer and conform to the standard ANSI/IEEE C57.12.90, Reference [7]. In cases where the specific information is not available in the early stages of planning the proposed Wind Farm, as described in the introduction to Section 6, proponents must submit a maximum rated value of the transformer acoustic emissions.

The requirements do not apply to the small transformer units attached to each wind turbine. These small transformers are insignificant noise sources and, therefore, their contributions do not require assessment.

The acoustic emissions data must be used in the noise impact assessment at each receptor.

6.2.5 Noise Sources and Locations

All wind turbine units and Transformer Substations must be assigned a unique source identification and must be listed along with their Universal Transverse Mercator (UTM) coordinates in a table in the report. The table should be provided in electronic form along with the report. A sample table format is shown in Table 4.

The source identifications should remain consistent throughout the submission and review process. Any changes to source identifications in revised versions of the Noise Assessment Report should be explicitly stated.

6.3 **Receptors**

For the purposes of this document, receptors mean Points of Reception and Participating Receptors, including vacant lots described in Section 6.3.3.

The definitions of a Point of Reception and a Participating Receptor are given in Section 3. The distance requirements for detailed noise assessments at receptors are described in Section 6.4.1. To provide clarity and consistency in the detailed noise assessments, the following describes the specific receptor locations for assessment purposes:

6.3.1 Wind Farm Does Not Include Transformer Substation

a) Single Storey Dwelling

- 4.5 m above grade at the centre of the dwelling; or
- 1.5 m above grade and 30 m horizontally from the façade of the dwelling in the direction of each wind turbine location. If the 30 m radius spans beyond the property line of the dwelling then the receptor location is at the property line.

Either of the two locations is acceptable for assessment⁴.

b) Two Storey Dwelling (or Raised Bungalow)

- 4.5 m above grade at the centre of the dwelling.

c) Three Storey or Higher Dwelling

- at the centre of the highest storey of the dwelling.

6.3.2 Wind Farm Includes Transformer Substation

a) Dwellings up to Two Storey High

- 4.5 m above grade at the centre of the dwelling; or
- 1.5 m above grade and 30 m horizontally from the façade of the dwelling in the direction of each wind turbine location. If the 30 m radius spans beyond the property line of the dwelling then the receptor location is at the property line.

The location that results in the higher noise impact must be selected⁵.

b) Three Storey or Higher Dwelling

- at the centre of the highest storey of the dwelling; or
- 1.5 m above grade and 30 m horizontally from the façade of the dwelling in the direction of each wind turbine location. If the 30 m radius spans beyond the property line of the dwelling then the receptor location is at the property line.

The location that results in the higher noise impact must be selected⁶.

6.3.3 Vacant Lots

Receptors include vacant lots that have been zoned by the local municipality to permit residential or similar noise-sensitive uses, as described in the definition of a Point of Reception in Section 3.

The receptor location, if unknown at the time of the proposal, shall be based on a 1 hectare (10,000 m²) building envelope within the vacant lot property that would reasonably be expected to

⁴ Assessment at the centre of the dwelling is simpler. The sound level at 4.5 m above grade at the centre of the dwelling is generally higher.

⁵ Assessment at the centre of the dwelling is simpler. The sound level at 4.5 m above grade at the centre of the dwelling is generally higher except where transformer substation noise is a factor.

⁶ Assessment at the centre of the dwelling is simpler. The sound level at the highest storey at the centre of the dwelling is generally higher except where transformer substation noise is a factor.

contain the use, and that conforms with the municipal zoning by-laws in effect. The specific receptor location for assessment purposes should be assumed to be 4.5 m above grade and:

- consistent with the typical building pattern in the area, or
- at the centre of the 1 hectare building envelope.

6.3.4 Area Classification of Receptors

Based on the rural nature of the areas surrounding most wind power projects, the Class 3 Area sound level limits shown in Table 1 and Figure 1 apply to all receptors, regardless of their proximity to a roadway, unless it can be shown clearly that less restrictive sound level limits are justified.

Less restrictive sound level limits for receptors within their designated area classification must be justified by analysis of hourly-traffic volumes data or by hourly acoustic monitoring results consistent with Publication NPC-206, Reference [3]. The use of general estimates, such as the Annual Average Daily Traffic data (AADT), is an insufficient method for determining the minimum hourly sound level of the background.

6.3.5 Receptors and Locations

All receptors must be assigned a unique receptor identification and must be tabulated along with their precise coordinates in the report. The table should be provided in electronic form along with the report. A sample table format is shown in Table 5 and Table 6.

The receptor identifications should remain consistent throughout the review process. Any changes to receptor identifications in revised versions of the Noise Assessment Report must be explicitly stated.

6.4 **Detailed Noise Impact Assessment**

Assessment of the sound levels produced by a Wind Farm, i.e. detailed noise impact assessment, must be made at each Point of Reception and Participating Receptor, within the distance requirements described in Section 6.4.1. In the event that all Points of Reception and Participating Receptors are outside the distance requirements described in Section 6.4.1, a detailed noise impact assessment is not required and the provisions contained in Sections 6.4.2 through to 6.4.10 are not applicable. Note that all proposals for Wind Farm projects must address the requirements described in Sections 6.1, 6.2 and 6.3, and Table 4, Table 5 and Table 6, even if a detailed noise assessment is not required.

The noise assessment must represent the maximum rated output of the Wind Farm, and reflect the principle of "predictable worst case" noise impact, Publications NPC-205 and NPC-232, References [2] and [4].

6.4.1 Distance Requirement

a) Wind Farm Does Not Include Transformer Substation

- A detailed noise impact assessment of the Wind Farm is required if one or more Points of Reception or Participating Receptors are located within 1500 m of a wind turbine generator.

b) Wind Farm Includes Transformer Substation

- A detailed noise impact assessment of the Wind Farm including a Transformer Substation is required if one or more Points of Reception or Participating Receptors are located within 1500 m of a wind turbine generator.
- A detailed noise impact assessment limited to the Transformer Substation is required if no Points of Reception or Participating Receptors are located within 1500 m of a wind turbine generator but a Point of Reception or a Participating Receptor is located within 1000 m of a Transformer Substation.

6.4.2 Whole Wind Farm Assessment

In the event that a detailed noise impact assessment is required, the assessment must not be limited to a 1500 m radius from a receptor, but must consider the impact of the whole Wind Farm subject to the limitations relating to very large distances described in Section 6.4.9.

6.4.3 Transformer Substation Assessment

In general, Transformer Substation noise impact must be assessed in combination with the noise impact from the wind turbine generators. In the unique case where the noise impact is caused only by the Transformer Substation, as described in Section 6.4.1 b), the detailed noise impact assessment is only required to consider the sound levels from the Transformer Substation.

6.4.4 Impact of Adjacent Approved Wind Farms

If a Point of Reception or a Participating Receptor is or can be affected by adjacent, approved⁷ Wind Farms, the detailed noise impact assessment must address the combined impact of the proposed and the adjacent Wind Farms. The distance requirements described in Sections 6.4.1 and 6.4.9 apply.

Note that in accordance with Section 6.4.2, where a detailed noise impact assessment is required, it must consider all the wind turbine generators and Transformer Substations in the proposed as well as in the adjacent approved Wind Farms, subject to the limitations relating to very large distances described in Section 6.4.9.

6.4.5 Impact of Adjacent Wind Farms in the Process of Being Planned

If a Point of Reception or a Participating Receptor is or can be affected by adjacent Wind Farms in the process of being planned⁸, the detailed noise impact assessment must address, subject to available information⁹, the combined impact of the proposed and the adjacent Wind Farms. The distance requirements described in Sections 6.4.1 and 6.4.9 apply.

⁷ For the purposes of this document, a Wind Farm is considered to be “approved” if a Certificate of Approval (Noise) under section 9 of the *Environmental Protection Act* has been issued.

⁸ For the purposes of this document, a Wind Farm is considered to be “in the process of being planned” if a Notice of Commencement has been issued for the project in accordance with the Environmental Screening Process prescribed under Ontario Regulation 116/01 under the *Environmental Assessment Act*, but for which a Certificate of Approval (Noise) under section 9 of the *Environmental Protection Act* has not yet been issued.

⁹ The combined impact would be expected to be assessed if, for example, the information on turbine locations and models at an adjacent proposed Wind Farm is publicly available (e.g., through a Screening Report or Environmental Review Report under the Environmental Screening Process).

Note that in accordance with Section 6.4.2, where a detailed noise impact assessment is required, it must consider all the wind turbine generators and Transformer Substations in the proposed Wind Farm as well as in the adjacent Wind Farm in the process of being planned, subject to the limitations relating to very large distances described in Section 6.4.9.

6.4.6 Assessment of Participating Receptors

A receptor is a Participating Receptor and not considered as a Point of Reception if the property of the receptor is associated with the Wind Farm, see definition in Section 3. The sound level limits stated in Section 5 do not apply to Participating Receptors.

Despite this exemption, it is prudent to design Wind Farms so as to minimize the noise impact on all receptors, including Participating Receptors.

In some cases, a detailed noise assessment may be required of a receptor that was considered a Participating Receptor for an adjacent approved Wind Farm, or is being considered as a Participating Receptor for an adjacent Wind Farm in the process of being planned. Unless the property owner has also entered into an agreement with the proponent of the proposed Wind Farm, the receptor shall be considered a Point of Reception for the purposes of the detailed noise impact assessment for the proposed Wind Farm.

6.4.7 Prediction Method

Predictions of the total sound level at a Point of Reception or a Participating Receptor must be carried out according to the method described in the standard ISO 9613-2, Reference [6]. The calculations are subject to the specific parameters indicated in Section 6.4.10.

6.4.8 Adjustment for Special Quality of Sound

Should the manufacturer's data indicate that the wind turbine acoustic emissions are tonal, the acoustic emissions must be adjusted by 5 dB for tonality, in accordance with Publication NPC-104, Reference [1]. Otherwise, the prediction should assume that the wind turbine noise requires no adjustments for special quality of sound described in Publication NPC-104, Reference [1].

No special adjustments are necessary to address the variation in wind turbine sound level (swishing sound) due to the blade rotation, see Section 4. This temporal characteristic is not dissimilar to other sounds to which no adjustments are applied. It should be noted that the adjustments for special quality of sound described in Publication NPC-104, Reference [1], were not designed to apply to sounds exhibiting such temporal characteristic.

The calculations of the transformer noise must be consistent with the provisions of Section 6.2.4. Furthermore, since transformer acoustic emissions are tonal, an adjustment of 5 dB must be added to the specified acoustic emissions in accordance with Publication NPC-104, Reference [1].

6.4.9 Sound Level Contributions from Distant Wind Turbine Generators

The standard on which the noise impact prediction method is based, namely standard ISO 9613-2, Reference [6], is designed for source/receiver distances up to about 1000 m. Although the use of the standard may be extended to larger distances, other factors affecting sound level contributions from the distant sources may need to be considered. In practice, sound level contributions from sources such as wind turbines located at very large distances from receptors are affected by additional attenuation effects.

To address the above in a prediction method, contributions from sources located at very large distances from receptors, larger than approximately 5 km, do not need to be included in the calculation.

6.4.10 Specific Parameters

The assessment must use the following parameters that have been designed to provide clarity and consistency as well as reflect the principle of the “predictable worst case” noise impact.

- a) All calculations must be performed in terms of octave band sound levels (63 to 8000 Hz) and for each integer wind speed from 6 to 10 m/s.
- b) The attenuation due to atmospheric absorption must be based on the atmospheric attenuation coefficients for 10°C temperature and 70% relative humidity, specifically:

Table 2 Atmospheric Absorption Coefficients

Centre Octave Band Frequency (Hz)	63	125	250	500	1000	2000	4000	8000
Atmospheric Absorption Coefficient (dB/km)	0.1	0.4	1.0	1.9	3.7	9.7	32.8	117.0

- c) The term for Ground Attenuation must be calculated using the “General” method in the standard ISO 9613-2, Reference [6]. For Class 2 and 3 Areas, the assessment must use ground factor values not exceeding the following:

$$G_s = 1.0$$

$$G_m = 0.8$$

$$G_r = 0.5$$

Where G_s is ground factor for the source region,
 G_m is ground factor for the middle region, and
 G_r is ground factor for the receiver region.

Alternatively, a global value ground factor not exceeding 0.7 may be used.

Ground factor values for assessments in Class 1 Areas are not specified in this document. The choice of the ground factor values for assessments in Class 1 Areas is site-specific.

6.5 Results and Compliance

6.5.1 Presentation of Results

Results of the noise impact assessment calculations must be presented in accordance with the Noise Impact Assessment Summary Tables, Table 7 and Table 8. In addition, the results should be plotted on drawings of the site plan, showing property boundaries, noise sources and receptor locations with their identifications. A suitable scale for these drawings is 1 cm : 250 m.

A separate drawing must be presented for each of the following wind speeds: 6, 8 and 10 m/s. The sound level scale should be the same on all drawings. If practical, each drawing should show the sound level contours for the 40 dBA level as well as the contour for the applicable sound level limit. The drawings should be included as an Appendix.

6.5.2 Assessment of Compliance

Compliance must be based on the comparison of the combined sound levels from all sources, described in Section 6, at each Point of Reception with the sound level limits stated in Section 5. All calculations and the determination of compliance with the sound level limits must be presented to a precision of one decimal place.

6.6 Summary Tables

6.6.1 Wind Turbine Acoustic Emissions Summary Table

The wind turbine acoustic emissions data used in the calculations must be presented as shown in Table 3. Separate tables should be used if the project involves different models of equipment.

Table 3 Wind Turbine Acoustic Emissions Summary

Make and Model: Electrical Rating: Hub Height (m): Wind shear coefficient, as per Section 6.2.3¹⁰:										
	Octave Band Sound Power Level (dB)									
	Manufacturer's Emission Levels					Adjusted Emission Levels				
Wind Speed¹¹ (m/s)	6	7	8	9	10	6	7	8	9	10
Frequency¹² (Hz)										
63										
125										
250										
500										
1000										
2000										
4000										
8000										
A-weighted										

¹⁰ Adjustment based on the differences in wind shear factors reflecting manufacturer's data and on-site data.

¹¹ At 10 m reference height.

¹² Centre Octave Band Frequency.

6.6.2 Locations of Wind Turbine Generators, Transformer Substations and Receptors

Location coordinates of all wind turbine generators, Transformer Substations, Points of Reception and Participating Receptors must be given in accordance with Table 4, Table 5 and Table 6.

Table 4 Wind Turbine Locations

Project Name:				
Identifier	Equipment Make & Model	UTM Coordinates		Remarks
		X	Y	

Changes in ID or location in revised submissions must be clearly identified under the "Remarks" column.

Table 5 Point of Reception Locations

Project Name:			
Point of Reception ID	Description	UTM Coordinates	
		X	Y

Table 6 Participating Receptor Locations

Project Name:			
Receptor ID	Description	UTM Coordinates	
		X	Y

6.6.3 Noise Impact Assessment Summary Tables

Table 7 Combined Noise Impact Summary – Points of Reception

Point of Reception ID	Description	Height (m)	Distance to Nearest Turbine (m)	Nearest Turbine ID	Calculated Sound Level at Selected Wind Speeds (dBA)					Sound Level Limit (dBA)								
					6	7	8	9	10	6	7	8	9	10				

Values in the table that exceed the applicable limit should be **Underlined and Bolded**.

Table 8 Combined Noise Impact Summary – Participating Receptors

Participating Receptor ID	Description	Height (m)	Distance to Nearest Turbine (m)	Nearest Turbine ID	Calculated Sound Level at Selected Wind Speeds (dBA)					
					6	7	8	9	10	

Table 9 Wind Turbine Noise Impact Summary – Points of Reception

Point of Reception ID	Description	Height (m)	Distance to Nearest Turbine (m)	Nearest Turbine ID	Calculated Sound Level at Selected Wind Speeds (dBA)					Sound Level Limit (dBA)								
					6	7	8	9	10	6	7	8	9	10				

Values in the table that exceed the applicable limit should be **Underlined and Bolded**.

Table 10 Wind Turbine Noise Impact Summary – Participating Receptors

Participating Receptor ID	Description	Height (m)	Distance to Nearest Turbine (m)	Nearest Turbine ID	Calculated Sound Level at Selected Wind Speeds (dBA)				
					6	7	8	9	10

6.7 Appendices

All information necessary to support the conclusions of the report, but not specifically described as required in Section 6, should be referenced and attached as Appendices to the report. Supporting information includes but is not limited to specifications, drawings, letters/agreements, photos, measurements and miscellaneous technical information.

In addition, sample calculation should be included in the Appendices. The sample calculation must include at least one detailed calculation for a source to receiver “pair,” preferably addressing the closest wind turbine unit. The sample calculation must represent all other “pairs.” If applicable, a sample calculation for the Transformer Substation is also required.

In cases where a Transformer Substation is part of the Wind Farm, Table 11 and Table 12 must be included in the Appendices:

Table 11 Transformer Substation Noise Impact Summary – Points of Reception

Point of Reception ID	Description	Distance to Transformer Substation (m)	Calculated Sound Level (dBA)	Sound Level Limit (dBA)

Values in the table that exceed the applicable limit should be **Underlined and Bolded**.

Table 12 Transformer Substation Noise Impact Summary – Participating Receptors

Point of Reception ID	Description	Distance to Transformer Substation (m)	Calculated Sound Level (dBA)

ATTACHMENT B

GE 2.5-103 TURBINE DATA

JULY, 2011

GE Energy

Commercial Documentation Wind Turbine Generator Systems 2.5-103 - 60 Hz

Product Acoustic Specifications

Canada Specific

Normal Operation according to IEC 61400-11



imagination at work

All technical data is subject to change in line with ongoing technical development!

Copyright and patent rights

This document is to be treated confidentially. It may only be made accessible to authorized persons. It may only be made available to third parties with the expressed written consent of General Electric Company.

All documents are copyrighted within the meaning of the Copyright Act. The transmission and reproduction of the documents, also in extracts, as well as the exploitation and communication of the contents are not allowed without express written consent. Contraventions are liable to prosecution and compensation for damage. We reserve all rights for the exercise of commercial patent rights.

© 2010 General Electric Company. All rights reserved.

GE and  are trademarks and service marks of General Electric Company.

Other company or product names mentioned in this document may be trademarks or registered trademarks of their respective companies.



imagination at work

Table of Contents

1	Introduction	5
2	2.5-103 Product Normal Operation Acoustic Performance.....	6
2.1	2.5-103 Normal Operation Calculated Apparent Sound Power Level.....	6
2.2	2.5-103 Normal Operation Calculated Tonality.....	7
3	2.5-103 Product Additional Information	8
3.1	2.5-103 Wind Speeds at Reference Height extrapolated to Hub Height.....	8
3.2	2.5-103 Testing Uncertainty and Product Variation per IEC/TS 61400-14.....	8
3.3	IEC 61400-11 and IEC/TS 61400-14 Terminology.....	9

1 Introduction

This document defines the noise emission characteristics of the wind turbine series 2.5-103, 60 Hz version, equipped with 103 m rotor diameter (GE 50.2 type blade) operating in normal operation (NO).

General Electric continuously verifies specifications with measurements, including those performed by independent institutes.

The calculated apparent sound power level $L_{WA,k}$ as function of v_{10m} (reference wind speed 10 m above ground level) is provided for **normal operation (NO)** over cut-in to cut-out wind speed range.

The corresponding wind speeds at hub height v_{HH} are provided assuming different standard hub heights and a logarithmic wind profile.

If a wind turbine noise performance test is to be carried out, it needs to be done in accordance with both IEC 61400-11 and GE's "Machine noise performance test" reference guidelines.

Paragraph §2 provides **nominal calculated acoustic performance** for:

- 2.5-103 (60 Hz) calculated apparent sound power level $L_{WA,k}$ as function of v_{10m} and at **95% rated electrical power** per IEC 61400-11.
- 2.5-103 (60 Hz) tonality level $\Delta L_{a,k}$ per IEC 61400-11

Paragraph §3 provides 2.5-103 acoustic performances additional data:

- The wind speeds at reference height v_{10m} extrapolated to v_{HH} (wind speed at hub height)
- Uncertainty information
- IEC 61400-11 and IEC/TS 61400-14 additional information

2 2.5-103 Product Normal Operation Acoustic Performance

2.1 2.5-103 Normal Operation Calculated Apparent Sound Power Level

The Table 1 provides nominal acoustic specifications for 2.5-103 equipped with 103 m rotor diameter (GE 50.2 type blade) and 100 m hub height as function of wind speed v_{10m} (reference wind speed 10 m above ground level), operating at normal operation (NO) per IEC 61400-11 standard and GE's "Machine noise performance test" reference guidelines:

Wind speed at v_{10m} [m/s]	$L_{WA,k}^*$ Apparent sound power level [dB]
≤ 5	≤ 97.1
5.5	99.7
6	≤ 102.0
6.5	≤ 103.4
7	≤ 104.0
8	≤ 104.0
9	≤ 104.0
10-cut-Out	≤ 104.0

Table 1: Normal operations, 2.5-103 wind turbine, 50.2 m blades (103 m rotor), 100 m hub height, apparent sound power level at wind speed v_{10m} .

At wind speeds lower than 5 m/s the sound power levels decreases, and may get so low that the wind turbine noise becomes indistinguishable from the background noise. For a conservative calculation the data at 5 m/s may be used.

At wind speeds above 9 m/s turbine has reached rated power and the increasing pitch angle decreases the noise level. For a conservative calculation the data at 9 m/s may be used.

The nominal acoustic performances for **2.5-103**, 60 Hz version, equipped with 103 m rotor diameter (GE 50.2 type blade) operating in **normal operation** (NO), specified at **95 % rated electrical power**:

- The calculated apparent sound power level is $L_{WA,k} \leq 104.0$ dBA.

* $L_{WA,k}$ indicates apparent sound power level per IEC-61400-11 standard measured in dB, A-weighted 10 base logarithmic value of apparent sound power relative to reference sound power of 10^{-12} W.

2.2 2.5-103 Normal Operation Calculated Tonality

The nominal acoustic performance for **2.5-103**, 60 Hz version, equipped with 103 m rotor diameter (GE 50.2 type blade) operating in **normal operation** (NO), specified at reference ground measuring distance **R₀**, measurement position #1 per both IEC 61400-11 and GE's "Machine noise performance test" reference guidelines:

- Tonal audibility $\Delta L_{a,k} < 2$ dB.

3 2.5-103 Product Additional Information

3.1 2.5-103 Wind Speeds at Reference Height extrapolated to Hub Height

The wind speeds v_{10m} at reference height (10 m above ground) can be extrapolated from v_{10m} to v_{HH} (wind speed at hub height), per IEC 61400-01, assuming surface roughness of $z_{0,ref} = 0.05$ m typical average condition and using:

$$V_{10m\ height} = V_{hub} \frac{\ln\left(\frac{10m}{z_{0ref}}\right)}{\ln\left(\frac{hub\ height}{z_{0ref}}\right)}$$

Meaning wind speeds from Table 1 can be extrapolated to 100 m hub height using $v_{HH} = v_{10m} * 1.43$ and to 85 m hub height using $v_{HH} = v_{10m} * 1.40$ per Table 2.

Wind speed at 10 m reference height v_{10m} [m/s]	Wind speed at 85 m hub height $V_{HH=85}$ [m/s]	Wind speed at 100 m hub height $v_{HH=100}$ [m/s]
≤ 5	≤ 7.0	≤ 7.2
5.5	7.7	7.9
6	8.4	8.6
6.5	9.1	9.3
7	9.8	10.0
8	11.2	11.5
9	12.6	12.9
10-cut-out	13.7-cut-out	14-cut-out

Table 2: Relation between wind speed at reference height v_{10m} and wind speeds at different hub heights v_{HH} for $z_{0,ref} = 0.05$ m

3.2 2.5-103 Testing Uncertainty and Product Variation per IEC/TS 61400-14

Per IEC/TS 61400-14, L_{WAd} is the maximum apparent sound power level resulting from n measurements performed according to IEC 61400-11 standard for 95 % confidence level: $L_{WAd} = \overline{L_{WA}} + K$, where $\overline{L_{WA}}$ is the mean apparent sound power level from n IEC 61400-11 testing reports and $K = 1,645 \cdot \sigma_T$.

The testing standard deviation values σ_T , σ_R and σ_P for measured apparent sound power level are described by IEC/TS 61400-14, where σ_T is the total standard deviation, σ_P is the standard deviation for product variation and σ_R is the standard deviation for test reproducibility.

Assuming $\sigma_R < 0.8$ dB and $\sigma_P < 0.8$ dB typical values, leads to calculated $K < 2$ dB for 95 % confidence level.

3.3 IEC 61400-11 and IEC/TS 61400-14 Terminology

- $L_{WA,k}$ is wind turbine apparent sound power level (referenced to $10^{-12}W$) measured with A-weighting as function of reference wind speed v_{10m} . Derived from multiple measurement reports per IEC 61400-11, it is considered as a mean value
- σ_P is the product variation i.e. the 2.5-103 unit-to-unit product variation; typically < 0.8 dB
- σ_R is the overall measurement testing reproducibility as defined per IEC 61400-11; typically < 0.8 dB with adequate measurement conditions and sufficient amount of data samples
- σ_T is the total standard deviation combining both σ_P and σ_R
- $K = 1,645 \cdot \sigma_T$ is defined per IEC/TS 61400-14 for 95 % confidence level
- R_0 is the ground measuring distance from the wind turbine tower axis per IEC 61400-11
- $\Delta_{La,k}$ is the audibility according to IEC 61400-11, described as potentially audible narrow band sound

References:

- IEC 61400-1, Wind turbines – part 1: Design requirements, ed. 3, 2005-08
- IEC 61400-11, wind turbine generator systems part 11: Acoustic noise measurement techniques, ed. 2.1, 2006-11
- IEC/TS 61400-14, Wind turbines – part 14: Declaration of apparent sound power level and tonality values, ed. 1, 2005-03
- MNPT – Machine Noise Performance Test, Technical documentation, GE 2007

Technical Documentation

Wind Turbine Generator Systems

2.5-103 – 60 Hz

Detailed Acoustic Data Addendum

Normal Operation according to IEC 61400-11

Canada Specific



imagination at work

Gepower.com

Visit us at

www.gewindenergy.com

All technical data is subject to change in line with ongoing technical development!

Copyright and patent rights

This document is to be treated confidentially. It may only be made accessible to authorized persons. It may only be made available to third parties with the expressed written consent of General Electric Company.

All documents are copyrighted within the meaning of the Copyright Act. The transmission and reproduction of the documents, also in extracts, as well as the exploitation and communication of the contents are not allowed without express written consent. Contraventions are liable to prosecution and compensation for damage. We reserve all rights for the exercise of commercial patent rights.

© 2011 General Electric Company. All rights reserved.

GE and are trademarks and service marks of General Electric Company.

Other company or product names mentioned in this document may be trademarks or registered trademarks of their respective companies.

1 Introduction

This document is intended to meet country specific regulations which require more specific octave band power spectra from wind turbines, in order to support detailed acoustic data input for the purpose of wind park detailed acoustic assessment.

In addition to the 2.5-103 wind turbine product acoustic specifications the following detailed data are provided:

Calculated octave band apparent sound power level $L_{WA,k}$

2 2.5-103 Calculated Octave Band Spectra – Canada Specific

The table below provides simulated, A-weighted octave band spectra as a function of standardized wind speed at 10 m height, and expressed as apparent sound power levels.

The uncertainties for octave sound power levels are generally higher than for total sound power levels.

Guidance is given in IEC 61400-11, Annex D.

2.5-103 – A-Weighted Octave Spectra (dB)

Standard WS at 10m [m/s]	5	5.5	6	6.5	7	8	9	10- Cutout
Hub Height WS @ 100m [m/s]	7.2	7.9	8.6	9.3	10.0	11.5	12.9	14- Cutout
Frequency [Hz]								
32	72.9	75.7	78.4	80.6	80.8	80.9	81.1	81.1
63	82.6	85.4	88.1	90.2	90.5	90.5	90.7	90.8
125	86.9	89.7	92.3	94.5	94.6	94.7	94.9	94.9
250	89.7	92.3	94.7	96.6	96.4	95.7	95.9	95.9
500	90.7	93.3	95.7	97.5	97.3	96.2	95.4	95.2
1000	91.0	94.2	96.6	98.4	98.4	98.7	98.6	98.4
2000	88.2	90.7	93.2	95.3	95.7	96.9	97.3	97.6
4000	82.2	84.3	86.2	87.7	87.5	88.1	89.0	89.4
8000	65.8	68.2	70.3	71.9	71.6	71.4	71.4	71.0
Lwa [dBA]	96.9	99.6	102.1	104.0	104.0	104.0	104.0	104.0

Table 1: Octave Spectra for 2.5-103 - hub height wind speeds were calculated based on equation (7) from IEC standard 61400-11:2002, using a representative roughness height of 0.05 m

ATTACHMENT C

SAMPLE CALCULATION FOR NIGHT TIME NOISE IMPACT ON R288

SEPTEMBER, 2011

ISO 9613-2 Sample Calculation

Receiver: R288

Project: McLean's Mountain Wind Farm

Project Number: 8020

Time Period	Total (dBA)
Day	39.9
Night	39.9

Receiver Name	Receiver ID	X	Y	Z	Ground
R288	R288	425189	5087124	293.5	289.02

Source Name	Source ID	X	Y	Z	Ground	RefIOrd	LxT	LxN	L/A	Dist.	hm	Freq	Adiv	KOb	Agr	Abar	z	Aatm	Afol	Ahous	Cmet	CmetN	Dc	RL	LtotT	LtotN
T20	T20	425263	5086379	392.2	293.85	0	104.0	104.0	1.0	755	51.7	0	68.6	0	-0.6	0.0	0.0	2.4	0.0	0.0	0.0	0.0	0.0	0.0	33.6	33.6
T13	T13	425578	5087836	384.8	286.47	0	104.0	104.0	1.0	817	51.2	0	69.2	0	-0.5	0.0	0.0	2.5	0.0	0.0	0.0	0.0	0.0	0.0	32.8	32.8
T12	T12	424685	5087875	412.9	314.62	0	104.0	104.0	1.0	912	50.3	0	70.2	0	-0.5	0.0	0.0	2.7	0.0	0.0	0.0	0.0	0.0	0.0	31.6	31.6
T19	T19	426002	5086354	368.4	270.11	0	104.0	104.0	1.0	1123	52.2	0	72.0	0	-0.5	0.0	0.0	3.1	0.0	0.0	0.0	0.0	0.0	0.0	29.4	29.4
T14	T14	424005	5087874	417.0	318.69	0	104.0	104.0	1.0	1407	44.3	0	74.0	0	-0.5	0.0	0.0	3.6	0.0	0.0	0.0	0.0	0.0	0.0	26.9	26.9
T15	T15	426514	5087605	373.6	275.27	0	104.0	104.0	1.0	1412	53.5	0	74.0	0	-0.5	0.0	0.0	3.6	0.0	0.0	0.0	0.0	0.0	0.0	26.9	26.9
T06	T06	425374	5088648	389.7	291.39	0	104.0	104.0	1.0	1538	49.0	0	74.7	0	-0.5	0.0	0.0	3.8	0.0	0.0	0.0	0.0	0.0	0.0	25.9	25.9
T10	T10	426243	5088273	381.9	283.64	0	104.0	104.0	1.0	1562	54.1	0	74.9	0	-0.5	0.0	0.0	3.9	0.0	0.0	0.0	0.0	0.0	0.0	25.7	25.7
T05	T05	425967	5088867	388.3	290	0	104.0	104.0	1.0	1911	51.8	0	76.6	0	-0.5	0.0	0.0	4.4	0.0	0.0	0.0	0.0	0.0	0.0	23.5	23.5
T11	T11	423155	5087692	418.3	320	0	104.0	104.0	1.0	2115	43.4	0	77.5	0	-0.5	0.0	0.0	4.6	0.0	0.0	0.0	0.0	0.0	0.0	22.3	22.3
T09	T09	426960	5088349	377.5	279.21	0	104.0	104.0	1.0	2155	54.1	0	77.7	0	-0.5	0.0	0.0	4.7	0.0	0.0	0.0	0.0	0.0	0.0	22.1	22.1
T16	T16	423976	5085277	395.1	296.76	0	104.0	104.0	1.0	2212	46.8	0	77.9	0	-0.5	0.0	0.0	4.8	0.0	0.0	0.0	0.0	0.0	0.0	21.8	21.8
T28	T28	424742	5084943	381.3	283	0	104.0	104.0	1.0	2228	44.8	0	78.0	0	-0.5	0.0	0.0	4.8	0.0	0.0	0.0	0.0	0.0	0.0	21.7	21.7
T18	T18	423020	5086314	408.6	310.31	0	104.0	104.0	1.0	2318	47.5	0	78.3	0	-0.4	0.0	0.0	4.9	0.0	0.0	0.0	0.0	0.0	0.0	21.3	21.3
T23	T23	423091	5085958	401.3	303.04	0	104.0	104.0	1.0	2402	47.3	0	78.6	0	-0.4	0.0	0.0	5.0	0.0	0.0	0.0	0.0	0.0	0.0	20.9	20.9
T29	T29	423719	5084978	391.2	292.92	0	104.0	104.0	1.0	2603	45.3	0	79.3	0	-0.4	0.0	0.0	5.2	0.0	0.0	0.0	0.0	0.0	0.0	19.9	19.9
T30	T30	424258	5084654	384.0	285.68	0	104.0	104.0	1.0	2641	45.2	0	79.4	0	-0.4	0.0	0.0	5.3	0.0	0.0	0.0	0.0	0.0	0.0	19.8	19.8
T34	T34	423970	5084235	376.0	277.67	0	104.0	104.0	1.0	3137	42.0	0	80.9	0	-0.5	0.0	-1.3	5.8	0.0	0.0	0.0	0.0	0.0	0.0	17.8	17.8
T17	T17	421160	5086508	414.3	316.03	0	104.0	104.0	1.0	4077	44.0	0	83.2	0	-0.9	0.0	0.0	6.6	0.0	0.0	0.0	0.0	0.0	0.0	15.1	15.1
T21	T21	420869	5086170	411.3	313	0	104.0	104.0	1.0	4425	43.6	0	83.9	0	-1.0	0.0	0.0	6.9	0.0	0.0	0.0	0.0	0.0	0.0	14.3	14.3
Xfmr	Xfmr	423616	5087363	323.0	320	0	94.4	94.4	1.0	1591	2.1	0	75.0	0	0.6	4.2	0.1	3.7	0.0	0.0	0.0	0.0	0.0	0.0	10.9	10.9