



**NORTHLAND
POWER**

Rideau Lakes Solar Project

Draft Design and Operations Report

December 22, 2010



Northland Power Inc.
on behalf of
Northland Power Solar
Rideau Lakes L.P.
Toronto, Ontario

DRAFT Design and
Operations Report

Rideau Lakes Solar Project

H334844-0000-07-124-0094

Rev. 0

December 22, 2010

Disclaimer

This report has been prepared solely for the use of Northland Power Inc., who is submitting this document to the Ministry of the Environment as part of the Renewable Energy Approval process. This document is in DRAFT form and subject to further revision. The content of this document is not intended for the use of, nor is it intended to be relied upon by any person, firm or corporation.

Project Report

December 22, 2010

**Northland Power Inc.
Rideau Lakes Solar Project**

DRAFT Design and Operations Report

Table of Contents

1. Introduction	5
1.1 Background.....	5
1.2 Objective and Scope.....	5
2. Site Plan	6
3. Facility Design Plan.....	6
3.1 Site Constraints/Regulations	6
3.2 Facility Components	7
3.2.1 Civil Components	7
3.2.1.1 Security Gate, Fencing and Lighting	7
3.2.1.2 Access Roads.....	7
3.2.1.3 Drainage System.....	7
3.2.1.4 Foundations.....	7
3.2.1.5 Trenches for Cable and Instrumentation Control	8
3.2.1.6 Structural Support.....	8
3.2.1.7 Temporary Construction Staging Area.....	8
3.2.2 Electrical Equipment.....	8
3.2.2.1 Modules	8
3.2.2.2 Inverter.....	8
3.2.2.3 Intermediate Transformers	9
3.2.2.4 AC Switch	9
3.2.2.5 Main Step-Up Transformer.....	9
3.2.2.6 Substation Electrical Building.....	9
3.2.2.7 Service Equipment.....	9
3.2.2.8 Underground Conductor	9
3.2.3 Distribution Line	10
3.2.4 Stormwater Management/Erosion and Sediment Control	10
3.2.5 Water Supply and Sanitary System	10
4. Facility Operation Plan	10
4.1 Operations.....	10
4.2 Maintenance.....	11
5. Environmental Effects Monitoring Plan	11

6. Emergency Response and Communications Plan..... 15

6.1 Emergency Response..... 15

6.1.1 Fire..... 15

6.1.2 Personal Injury 15

6.1.3 Spills 16

6.2 Communications Plan for Non-Emergencies..... 17

7. References..... 17

Appendix A Site Layout

Appendix B Typical Equipment Details

List of Tables

Table 5.1	Summary of Potential Negative Environmental Effects and Proposed Mitigation Occurring During Operations Phase.....	13
Table 5.2	Environmental Effects Monitoring Plan – Design and Operations	14

Blank back

1. Introduction

1.1 Background

Northland Power Solar Rideau Lakes L.P. (hereinafter referred to as “Northland”) is a proposed 10-megawatt (MW) solar farm in the Township of Rideau Lakes, within the United Counties of Leeds and Grenville, Ontario. Northland has contracted Hatch to provide technical and environmental support in the preparation of the Renewable Energy Approval (REA) application. The Rideau Lakes Solar Project is proposed to be constructed on a parcel of land that is approximately 50 hectares (ha) in size, zoned rural, north of County Road 42.

The proposed Project will use solar photovoltaic technology to generate electricity. The solar modules will be mounted on fixed steel supports and arranged in the form of 8 arrays, each of 1.25 MW. Electricity generated by solar photovoltaic modules from each array will be converted from direct current (DC) to alternating current (AC) by an inverter, and subsequently stepped up from a medium voltage to 44 kV in order to connect to the nearby distribution line. The connection point will be on Narrow Locks Road, northeast of the Project location. The Project will connect to a distribution line that Hydro One will extend approximately 1000 m from its current location.

Construction of the Project will commence once the REA has been obtained and a power purchase agreement is finalized with the Ontario Power Authority. The construction period is estimated to be approximately 6 months in duration, with Project commissioning anticipated near the end of 2011.

1.2 Objective and Scope

The Design and Operations Report (hereinafter referred to as “the Report”) is required as a part of an application for all renewable energy projects that must submit in order to obtain a REA permit under Ontario Regulation (O. Reg.) 359/09 – *Renewable Energy Approvals Under Part V.0.1 of the Act*. The Report needs to clearly define

- the site plan
- the design of the facility and the equipment to be used
- how the Project will be operated
- how environmental effects will be monitored and mitigated
- how emergencies and communications will be managed.

The Report also functions as a communication tool for Aboriginal, public, agency and municipal consultation. A draft of the Design and Operations Report must be made public 60 days prior to the second public consultation meeting in accordance with Section 16 of O. Reg. 359/09 and provided to the Aboriginal communities more than 60 days prior to the second public consultation meeting.

Section 2 of the Report provides the site plan and describes the Project area features. Section 3 provides the plan for the facility design including a description of the facility components. Section 4 describes the facility operation plan and Section 5 provides the environmental effects monitoring

plan for the operation of the Project. Section 6 describes the emergency response and communications procedures planned for the Project.

2. Site Plan

The Project is located on privately owned land, approximately 50 ha in size and zoned rural. The site is west of Brockville, approximately 75 km north of Highway 401 with access via Narrow Locks Road (municipal road) from the northeast. The coordinates (longitude and latitude) of the leased land are 44.67048 and -76.274671. Appendix A shows the detailed site plan of the Project. The site plan includes the facility components such as the construction staging area, the area for PV modules, the location of each inverter, the transformer and the substation, the existing distribution lines, and the Project's distribution lines. The Project's location components will also be identified, such as the Project boundary and the proposed set back, the access roads, the drainage system, the surrounding area, etc.

The design and operation plan for each of these components is described in the subsequent sections. For additional information regarding the construction and installation of these components, please refer to the Construction Plan Report (Hatch 2010g).

The site plan also provides the location of the noise receptors as defined by O. Reg. 359/09. The Noise Study (Hatch Ltd., 2010a) provides the detailed information on the noise sources, noise receptors and setback requirements. The site plan also includes the location of all Project area features within 125 m and 300 m.

A description of the specific features can be found as follows:

- natural heritage features can be found in the Natural Heritage Records Review Report (Hatch Ltd., 2010b), Natural Heritage Site Investigation Report (Hatch Ltd., 2010c) and Natural Heritage Evaluation of Significance Report (Hatch Ltd., 2010d) for the Project.
- waterbodies can be found in the Water Body Records Review Report (Hatch Ltd., 2010e) and the Waterbodies Site Investigation Report (Hatch Ltd., 2010f) for the Project
- socio-economic conditions can be found in the Section 3 of the Construction Plan Report (Hatch Ltd., 2010g)
- archaeological assessments, if applicable, can be found in the Stage 1 and 2 Archaeological Assessment completed for the Project (ARA, 2010).

3. Facility Design Plan

3.1 Site Constraints/Regulations

Based on the results of the natural heritage and water body environmental studies, as identified above, constraints to development on the Project location include

- a 30-m setback from the average annual high water mark of the tributary of Sucker's Creek south of the Project location.

These constraints have been integrated and taken into consideration in the facility design plan.

3.2 Facility Components

3.2.1 Civil Components

3.2.1.1 Security Gate, Fencing and Lighting

The site will be gated and fenced, with additional security measures installed as required by Northland. The fence design includes a chain-link fence, about 2 m high, including barbed wire on top of the fence. Inner fencing will also be erected around the substation area.

A set of lights will be installed near the entrance to the facility. Additional timed, motion-sensor security lighting may be installed.

3.2.1.2 Access Roads

As outlined in the site plan, a new access road, approximately 5 m long, will be necessary to support construction activities and will provide access to the site during the operation phase of the Project. The proposed 5-m wide access road will have ditches, swales and culverts (where necessary) for proper stormwater runoff, site drainage and to minimize road and soil erosion.

In addition to the main access road, a number of smaller access roads will be constructed. These will be approximately 3 m wide within the leased area, in order to minimize any impact to the environment and to the land. The design of the proposed 3-m wide access roads will be as per the 5-m wide access road.

3.2.1.3 Drainage System

The leased land is not known to have any pre-existing tile drains and the Project location slopes gently off site to the south. The existing tributary of Sucker's Creek can be found along the southern boundary of the Project location exiting to the east of the Project location. No other drainage features were noted during the site investigation.

Based on site visits and preliminary assessments, the existing drainage system appears to be adequate for the operations of the Project. In general, the drainage system for the facility will follow the existing drainage system on site. Runoff from the modules will not result in the requirement for drainage channels within the module rows. Drainage channels may be required along access roads to convey runoff.

3.2.1.4 Foundations

Foundation construction for electrical equipment, substation, and transformer oil spill containment basin comprises of excavation and removal of in situ material, placement of granular material, formwork, reinforcing steel, grounding, and placement of concrete. PV modules will be securely mounted on a lattice type structure supported by a driven pile foundation, helical pile, ground screw and/or Cast-In-Drilled-Hole (CIDH) pile depending on the soil conditions within the site. These underground support structures will be installed to a design depth below the frost line, capable of supporting the structure.

3.2.1.5 *Trenches for Cable and Instrumentation Control*

Trenches will be excavated for electrical cabling (including DC cables from the modules to the inverter and AC cables from the inverters to the intermediate transformers). Trenches will typically be 1 m deep by 0.5 m wide and will be excavated by using a 'ditch-witch' plough, or similar equipment. Where necessary, high density polyethylene (HDPE) conduits of suitable diameter will be provided to cross beneath roads.

3.2.1.6 *Structural Support*

The structural support for the system will be comprised of a steel and/or aluminum lattice structure supported by a pile foundation. This lattice structure will be mounted on the piles. Modules will then be mounted on the structural support system.

3.2.1.7 *Temporary Construction Staging Area*

The construction staging and laydown areas will be located throughout the Project location, including the south, west, east and northern corners of the Project location. The northern corner of the Project location is near the access road entrance from Narrow Locks Road (County Side Road 14) and in close proximity to the proposed substation and long-term parking area. The staging and laydown area will be approximately 25 m by 45 m in size. Fill material, including Granular A and B will be used to create a stable base.

3.2.2 **Electrical Equipment**

The Project is designed to generate 10 MW (AC) by using eight arrays of photovoltaic modules. Each array has a nominal capacity of 1.25 MW and is comprised of two sub-arrays, each with one inverter with a nominal capacity of 630 kW. The modules, inverters, intermediate transformers, AC switch, main step-up transformer, and the equipment control and monitoring system are the main electrical components of a solar facility. The facility will also require service equipment, so that field service is available at the center of each cluster. General information is provided below. All equipment will be appropriately grounded.

3.2.2.1 *Modules*

At this stage, Northland is completing market research and negotiating with different manufactures for supply of PV modules. As such, specific details such as dimensions, exact number of modules, spacing and setting of the modules are not available. However, a 280-W multi-crystalline solar module has been selected as a representative module.

The representative 280-W module's dimensions are 1956 mm by 992 mm by 50 mm, and each weighs 27 kg. Each module contains 72 multi-crystalline silicon solar cells (6 by 12), and the cells occupy an area of 156 mm by 156 mm. The module is covered by a 4-mm thick tempered glass, and framed in anodized aluminum alloy. Modules will be connected together in series into "strings", and these strings will be brought to combiner boxes.

3.2.2.2 *Inverter*

At this stage, Northland is completing market research and negotiating with different manufactures for the supply of inverters. Additionally, the requirements for grid interconnection as defined by

Hydro One are evolving and will impact the final selection of the inverter for this Project. As such, the final determination as to which inverter will be used for this Project has not been made.

At this stage, Northland has selected a representative inverter for the purposes of initial design and noise modeling. This inverter was chosen as it possesses representative noise characteristics for inverters of its size. Two 630-kW inverters will be housed inside a common enclosure, with one 1250-kW intermediate transformer immediately adjacent and outside of the enclosure. Each 630-kW inverter is 256 cm by 228 cm by 96 cm (HxWxD) in size, and weighs 1800 kg. Inverter enclosures will sit on (cast in place or pre-cast) concrete pads. Comparable inverters made by the main competitor to this supplier have similar dimensions, and are of similar weight.

3.2.2.3 *Intermediate Transformers*

Intermediate transformers will “step up” the power from 480 V to 27.6 kV. They will be located immediately adjacent to the inverter enclosures. Transformers will sit on (cast in place or pre-cast) concrete pads.

3.2.2.4 *AC Switch*

An AC switch will be provided to integrate power flowing from the eight arrays into the substation. The switch is likely to be an S&C Vista switch or equivalent, and will sit on a concrete pad in an enclosed casing.

3.2.2.5 *Main Step-Up Transformer*

The main step-up transformer will be in the substation yard. The substation yard will be fenced in and appropriately signed. The transformer will be oil filled and will sit in an oil containment system to prevent ground contamination in the event of a spill. The transformer will be equipped with level gauges to monitor gas and oil levels. Unusual gas and/or oil levels will trip an alarm to a remote monitoring station.

3.2.2.6 *Substation Electrical Building*

The substation electrical building will house the electrical control and monitoring systems. The building will be prefabricated and brought to site in two pieces on transport trucks. The building will sit on a concrete foundation that will be poured on site.

3.2.2.7 *Service Equipment*

Every 1.25-MW inverter enclosure will have station service power. The purpose of this service is to have power available as required for maintenance and general work on the solar array, and for enclosure heaters and cooling fans. Service equipment will be mounted in cabinets appropriate for outdoor use.

3.2.2.8 *Underground Conductor*

The conductor, which forms part of the solar farm collection system, will ideally be direct buried. It will be buried and surrounded by sand, as necessary, to ensure no thermal issues arise having to do with the properties of the native soil. Direct buried cables will not have an effect on the landowner/land users throughout the life of the Project. The conductor will be buried to a minimum depth of 915 mm and caution tape will be buried in the soil above the conductors so that any digging that

happens would come across the caution tape before the conductors. Once conductors are buried, native soil will be replaced in trench and graded such that there will be no disruption to land/drainage.

3.2.3 Distribution Line

Connecting to the Hydro One distribution system will require a 1000-m long overhead distribution line to be constructed between the Project's substation and the nearest point of connection (PC) with the local distribution system. Hydro One will construct this line expansion in accordance with its standards and practices and the Ontario Electrical Safety Code.

3.2.4 Stormwater Management/Erosion and Sediment Control

As stated above, drainage channels may be required along access roads to manage run-off. The design of the drainage channels/swales will be in accordance with industry standards. Erosion and sediment control measures and flow dissipaters (e.g., silt fence barriers, straw bale flow checks, rock flow check dam, revegetation) will be installed to ensure that the receiving water body is protected from erosion and sedimentation.

The entire site, with the exception of the access roads, will be revegetated with native grass or other suitable ground cover to promote surface water infiltration/uptake, prevent erosion and provide wildlife habitat.

3.2.5 Water Supply and Sanitary System

The Project does not require any water during operation other than potentially for cleaning the PV modules. It is anticipated that the rain and snow will generally be sufficient for this purpose; if not, Northland will contact local suppliers to provide water in tankers from off-site sources. No chemicals will be used in the event cleaning is deemed to be required.

Only two persons will work at the Project on an intermittent/regular basis and operation is controlled remotely. Therefore, sanitary facilities and drinking water is not anticipated to be required on site. If it is determined to be required, portable toilets, serviced by a local sanitation company, will be used to service the site.

4. Facility Operation Plan

4.1 Operations

As stated previously, the Project does not require any permanent on-site operator as it will be operated remotely. For general monitoring and maintenance purposes, two part-time or full-time local personnel may be hired and will be dispatched from a central operations office as needed. Any damage or faults with the PV modules and electrical systems will be alerted to staff remotely and repaired (or replaced) by facility staff or qualified professionals. Access to the site will be limited to Project personnel.

Any waste generated during the operations will be removed from the site and managed according to provincial and municipal requirements.

4.2 Maintenance

The vegetation coverage, drainage systems and trees will be monitored and maintained regularly. Suitable ground cover will be established under the modules and some form of vegetation abatement may be required several times throughout the summer months. No hazardous chemicals would be used for this vegetation control.

As previously described, the need to clean the solar modules will be determined according to local weather conditions, such as the quantity and frequency of rain and snow at the Project location. At the very most, it is expected that the modules will require cleaning quarterly, but it is possible cleaning the modules will not be necessary at all. If required, water trucks will bring water to the site to supply the water required. No chemicals would be used for cleaning.

The transformers will be visually inspected on a monthly basis and their status recorded. Any leaks will be repaired immediately. Spill response equipment will be left on site or in the maintenance trucks should leaks be observed.

The site will also be visually inspected for any erosion or sedimentation issues and remediation will be implemented as necessary to prevent environmental impacts.

5. Environmental Effects Monitoring Plan

The Technical Bulletin for Preparing the Operations and Design Report requires that an environmental effects monitoring plan be prepared that will show how the negative environmental effects will be mitigated and monitored to comply with O. Reg. 359/09.

As per the Technical Bulletin, the environmental effects monitoring plan for the design and operations phase of the Project can be comprised of summary tables, text descriptions and references to other. More specifically, the following are required:

1. A summary of all potential negative environmental effects caused by the project as given in the description of negative environmental effects in the Project Description Report.
2. Performance objectives for each potential negative effect, such that, if the performance objective is achieved, the effect will be substantially mitigated.
3. A description of all mitigation strategies planned to achieve performance objectives.
4. If there is an ongoing risk of potential negative environmental effects, a description of how the project will be monitored to ensure that mitigation strategies are meeting performance objectives
5. Contingency measures will be provided should monitoring reveal that negative effects are continuing to occur.

With respect to requirement 1 above, several Project reports have determined and documented the potential negative environmental effects. These reports and the context of the potential negative environmental effects are as follows:

- Project Description Report – preliminary potential negative environmental effects for features within 300 m of the Project

- Construction Plan Report – potential negative environmental effects caused by construction activities for features within 300 m of the Project
- Noise Report – potential negative environmental effects caused by transformers and inverters during operations on the receptors
- Stage 1 and 2 Archaeological Assessment – potential negative effects to archaeological resources from construction activities
- Natural Heritage Environmental Impact Study – potential negative effects to significant natural heritage features within 120 m of the Project for construction, operation and decommissioning phases
- Waterbodies Environmental Impact Study – potential negative effects to waterbodies within 120 m of the Project for construction, operation and decommissioning phases.

A summary of the potential negative environmental effects due to operational activities and proposed mitigation measures is provided in Table 5.1.

With respect to requirements 2 to 5 above, several Project reports have included environmental effects monitoring plans. These reports and the context of the monitoring plans are as follows:

- Natural Heritage Environmental Impact Study – monitoring requirements for natural features within 120 m of the Project for construction, operation and decommissioning phases
- Waterbodies Environmental Impact Study – monitoring requirements for waterbodies within 120 m of the Project for construction, operation and decommissioning phases.

Table 5.2 identifies (i) the potential negative effects that have an ongoing risk of occurrence throughout the operational period, (ii) the performance objectives and mitigation strategies to address those effects, (iii) monitoring protocols to confirm that performance objectives are being met and (iv) contingency measures in the event that objectives are not being met, as identified in the reports listed above. Table 5.2 also provides the monitoring plan for those environmental effects that were not included in the reports above, as per the definition of “environmental effects”. These include potential effects to the social and economic environments.

Table 5.1 Summary of Potential Negative Environmental Effects and Proposed Mitigation Occurring During Operations Phase

Environmental Component	Sources of Negative Effect	Potential Negative Effect	Mitigation Measures	Residual Negative Effect
Vegetation Communities/ Wildlife Habitat	Changes in site topography, placement of Project components, access roads, ditches and other less pervious areas.	Increase in surface water runoff.	Native plant cover planted around Project components instead of hay fields. Ditches and drainage conveyance features installed during construction activities will remain in place.	None. Native vegetation will maintain surface water management functions provided by existing hay fields.
	Accidental spills from transformer.	Adverse effects on vegetation and soil due to contamination.	Transformer to be placed on an oil containment pit. Spill control kits on site. Spill response procedure implemented in the event of an accident.	None – oil containment at main transformer will prevent releases to the environment in the event of a spill. No adverse effect anticipated.
Wildlife Communities	Maintenance activities.	Disturbance of wildlife due to noise and human presence resulting in wildlife avoidance of Project location.	Maintenance activities to be timed outside of bird breeding season (May through July) where possible.	None – Disturbance to wildlife due to maintenance activities less than existing disturbance due to agricultural activities.
Groundwater	Accidental spills from transformer.	Adverse effects on groundwater quality due to contamination.	Transformer to be placed on an oil containment pit. Spill control kits on site. Spill response procedure implemented in the event of an accident.	None – oil containment at main transformer will prevent releases to the environment in the event of a spill. No adverse effect anticipated.
Surface Water, Aquatic Habitat and Biota	Accidental spills from transformer.	Adverse effects on surface water quality due to contamination.	Transformer to be placed on an oil containment pit. Spill control kits on site. Spill response procedure implemented in the event of an accident.	None – oil containment at main transformer will prevent releases to the environment in the event of a spill. No adverse effect anticipated.
	Erosion due to surface water runoff from the Project area.	Adverse effects on water quality and aquatic habitat in receiving waterbodies .	Dense vegetation cover beneath solar modules and in ditches on the Project location.	None – provided mitigation is effective in preventing erosion and sedimentation.
	Washing of solar modules during maintenance activities.	Increase in surface water runoff and impact to surface water quality.	Rainfall is expected to be sufficient or water will be brought on site for cleaning purposes. If water from off-site is required, the amount used will be less than that occurring during a normal rainstorm event. No cleaning solutions will be used.	None – mitigation anticipated to be effective in preventing residual negative effects.
	Changes to surface water quality and surface water runoff rate as a result of the Project.	Indirect effect to the aquatic biota and habitat in receiving waterbodies.	Proposed mitigation for surface water quality and surface water runoff is anticipated to be sufficient to prevent adverse effects on aquatic biota and habitat.	None – mitigation anticipated to be effective in preventing residual negative effects.
Sound Levels	Noise emissions from transformer and Inverters.	Disturbances to nearby receptors due to noise emissions.	Installation of noise barrier around transformer if required to meet performance objectives.	Noise emissions will meet provincial requirements at nearest sensitive receptors.
Public and Facility Safety	Installation of the facility.	Installation of the facility will result in a potential risk to the public and facility, should trespassing on site occur.	Public access to the facility will be prevented through the use of fences, gates, and any other necessary security procedures.	Elimination or reduction in risk to public and facility safety.
Change in Visual Landscape	Installation of the facility.	Installation of the facility will result in a change to the local landscape. This may be perceived as a negative environmental effect.	Visual barriers will be considered, if necessary, and will be reviewed based on viability and effectiveness.	Elimination or reduction in visual disturbance of the facility if visual barriers implemented.

Table 5.2 Environmental Effects Monitoring Plan – Design and Operations

Negative Effect	Mitigation Strategy	Performance Objective	Monitoring Plan				Contingency Measures	
			Methodology	Monitoring Locations	Frequency	Rationale		Reporting Requirements
Increases in surface water runoff from Project location	Stormwater management measures including enhanced vegetated swales, ditch flow controls and filter strips.	Minimize changes to surface water runoff conditions to receiving waterbodies.	Visual assessment of structural stability of mitigation measures and identification of unintended impacts.	Throughout Project location.	Twice per year during site inspections	Visual monitoring will confirm that stormwater management measures remain as designed and allow identification of deficiencies	Reported in annual operational environmental monitoring report	Stormwater management measures will be remediated as necessary to ensure that they are functioning as designed
Erosion and sedimentation resulting in increased turbidity in site runoff	Vegetation to prevent erosion due to stormwater runoff.	No long-term erosion from site over and above existing conditions.	Visual monitoring of Project area to identify areas of erosion (e.g., rills, gullies).	Throughout Project location.	Twice per year during site inspections	Visual monitoring of erosion would identify potential areas of concern	Reported in annual operational environmental monitoring report	Erosion remediated as necessary to ensure no long-term erosion issues
Potential for adverse surface water, groundwater and soil quality due to accidental spills	Standard mitigation to prevent spills and minimize magnitude of spills that do occur. Installation of secondary containment around transformer.	No long-term environmental effects due to spills.	Visual monitoring of spill prevention/mitigation measures during maintenance activities.	Throughout Project location where maintenance occurs and at transformer location.	Twice per year during site inspections	Spill prevent and control measures to be monitored to ensure they are functioning as designed and protocols are being implemented as specified in plans to meet performance objectives	Reported in annual operational environmental monitoring report	Spill contingency measures implemented as necessary in the event of a spill. Following spill event, response will be reviewed to determine if additional or altered response protocols are necessary to meet performance objectives.
Noise levels disturbing nearby noise receptors	Noise mitigation strategies including installation of sound dampening equipment in the enclosures and/or a noise barrier around transformer and separate inverter and transformer locations to minimize cumulative noise emissions.	To minimize noise emissions at nearby noise receptors to the provincial guideline values.	Sound level monitoring as per any requirement documented in the REA issued for the Project.	At the closest sensitive receptors.	As per the frequency documented in the REA issued for the Project.	Auditory monitoring will confirm that noise emissions from the Project meet performance objectives.	Reported in annual operational environmental monitoring report	If Project components are not meeting performance objectives with respect to noise emissions, noise barriers will be installed as necessary.
Installation of the facility will result in a potential risk to the public and facility, should trespassing on site occur.	Public access to the facility will be prevented through the use of fences, gates, signs, and any other necessary security procedures.	Elimination of risk to public safety.	Site security monitoring will be ongoing to confirm adequacy of security measures.	Throughout the Project location and facility perimeter.	Ongoing	Site security monitoring will identify any breach in facility security.	Incidents of trespassing or vandalism will be reported to local authorities. Internal reporting to be determined by Northland Power.	Additional security measures will be implemented as required.
Installation of the Project will result in a change to the local landscape. This may be perceived as a negative environmental effect.	Visual barriers will be implemented as necessary.	Elimination/reduction in visual disturbance.	Concerns and complaints regarding visual disturbance and adequacy of visual barriers will be documented by the proponent.	To be determined.	As required	Documentation of visual disturbance and adequacy of visual barriers by local residents will result in evaluation of visual barrier necessity or effectiveness.	Internal reporting to be determined by Northland Power.	Visual barriers will be installed/upgraded as necessary.

6. Emergency Response and Communications Plan

6.1 Emergency Response

The Project Emergency Response Plan will be implemented through all phases of the Project. The purpose of the plan is to establish and maintain emergency procedures required for effectively responding to accidents and other emergency situations, and for minimizing associated losses.

Potential emergency scenarios which could occur during the construction, operation and decommissioning phases include, fire, personal injury and spills incidents. The following provides the emergency response and communications procedures to be used in response to these three potential emergency scenarios.

All Project personnel will be trained in the following emergency response and communications procedures.

Note that during the operation of the Project, Northland will establish a Communication and Emergency Response Plan to react to any Project specific emergencies. In the event of an emergency, Northland will mobilize its resources to the site to respond to the event.

6.1.1 Fire

Fire extinguishers will be located in strategic locations, such as Project vehicles and the substation electrical building. If a fire occurs, Project personnel will attempt to extinguish it, only if it is safe to do so. If there is any risk of personal injury, extinguishing the fire will not be attempted. If a fire can not be extinguished using the hand-held extinguishers, the Project area will be evacuated and Project personnel will immediately call 911 to summons the local fire department (and ambulance if required). Project personnel will notify inhabitants at all adjacent properties, if the fire appears able to move off of the Project location. All staff on site during the life of the Project will be trained in the procedure to deal with a fire and the use of an extinguisher.

During operations, a visible sign will be erected near the front gate of the facility. The sign will include instructions to call 911 and to call a Project phone number should a passerby notice an emergency. In the event of an emergency, Project personnel at site will contact 911 and the Project Manager.

All incidents will be documented and kept on file. Documentation will include date of incident, date of reporting, name of reporter, description of the incident, cause of the incident, actions taken, communications to outside groups and internal personnel and follow-up required.

6.1.2 Personal Injury

Should a personal injury occur on site that does not require an ambulance, the injured worker will be taken to the local hospital. First aid supplies and maps to the local hospitals will be kept in the Project trailer. A listing of the Project personnel trained in first aid/CPR will also be posted.

Should a personal injury occur on site that does require an ambulance, Project personnel will call 911 and assist the injured worker as required until emergency personnel arrive.

In all cases of personal injury, the Project Manager during the construction and decommissioning phases and the Northland Project Representative during operations will be notified immediately.

All incidents will be documented and kept on file. Documentation will include date of incident, date of reporting, name of reporter, name of injured, description of the incident, cause of the incident, actions taken, communications to outside groups and internal personnel and follow-up required, as required by Health and Safety Regulations.

6.1.3 Spills

The following spills procedures are as outlined in the Ministry of Environment's (MOE) "Spills Reporting – A Guide to Reporting Spills and Discharges" dated May 2007. Spills and the types of spills that require reporting are defined in the Ontario Environmental Protection Act and Ontario Regulation 675/98 Classification and Exemption of Spills and Reporting of Discharges.

Spills are the unintended release/discharge of material to air, land or water. The most likely decommissioning spill scenarios include: the release of sediments to waterbodies, sewage from portable washrooms and hazardous materials (e.g., compressed gases and petroleum hydrocarbons) from containers or vehicles.

Spills prevention measures are documented in the Environmental Impact Studies report completed for the Project. Should a spill occur, the following will be implemented:

- evaluate the scene for risks to human health and safety
- stop the spill, if it is safe to do so
- if there is immediate danger to human health, contact 911 for assistance, and notify anyone who may be directly impacted or is in harm's way
- during the construction and decommissioning phases notify the Project Manager of the incident, and notify the "Project Representative" during the operations phase
- contain and clean-up the spill, using on-site spill kit
- if required, contact outside spill response contractor for assistance
- document and report the spill to outside agencies, as required.

A spill kit will be available on site during the decommissioning phase and will contain equipment necessary for spills response. This will include absorbent pads, absorbent boom, polyethylene bags, neoprene gloves, protective goggles, plastic bin or metal drum, and multi-purpose granular sorbents.

Spills that could potentially occur during the life of the Project, and may need to be reported to the MOE include

- non-approved releases/discharges (including those to land, air and water)
- discharge of fluids greater than 100 L from a vehicle
- mineral oil releases greater than 100 L from an electrical transformer
- discharges (including sediment) to waterbodies.

The MOE Spills Action Centre phone number (1-800-268-6060) will be posted at the Project trailer.

Documentation for all spill incidents will be kept on file and sent to the MOE, as required.

Documentation will include date of incident, date of reporting, name of reporter, description of the incident, cause of the incident, type and amount spilled, actions taken, disposal of contaminated material, communications to outside groups and internal personnel and follow-up required.

6.2 Communications Plan for Non-Emergencies

A sign will be erected during all phases of the Project at the gate of the facility which will include a Project phone number (toll free) and website should the public have any questions, inquiries or complaints. All inquiries will be directed to the Northland Project Representative who will respond to the inquiry accordingly. All questions, inquiries and complaints will be logged electronically with the following information: date of question, inquiry or complaint, name, phone number, email address of the individual, response, date of response, and any follow-up issues.

During all phases of the Project should such conditions arise that the general public requires notification (such as Project changes requiring notifications), the public will be notified through newspaper and direct/general mailout, if required. Should agencies, such as the local municipality or the MOE, require notification, they will be sent the information directly by email, mail or telephone conversation. All communications will be documented and kept on file by Northland.

7. References

Archaeological Research Associates Ltd. (ARA). 2010. Stage 1 and 2 Archaeological Assessment, Rideau Lakes Solar Project, Rideau Lakes, United Counties of Leeds and Grenville, Ontario. Prepared for Hatch Ltd. August 2010.

Hatch Ltd. 2010a. Rideau Lakes Solar Project – Noise Assessment Study. Prepared for Northland Power Solar Rideau Lakes L.P. 2010.

Hatch Ltd. 2010b. Rideau Lakes Solar Project – Natural Heritage Records Review Report. Prepared for Northland Power Solar Rideau Lakes L.P. 2010.

Hatch Ltd. 2010c. Rideau Lakes Solar Project – Natural Heritage Site Investigations Report. Prepared for Northland Power Solar Rideau Lakes L.P. 2010.

Hatch Ltd. 2010d. Rideau Lakes Solar Project – Natural Heritage Evaluation of Significance Report. Prepared for Northland Power Solar Rideau Lakes L.P. 2010.

Hatch Ltd. 2010e. Rideau Lakes Solar Project – Water Body Records Review Report. Prepared for Northland Power Solar Rideau Lakes L.P. 2010.

Hatch Ltd. 2010f. Rideau Lakes Solar Project – Water Body Site Investigation Report. Prepared for Northland Power Solar Rideau Lakes L.P. 2010.







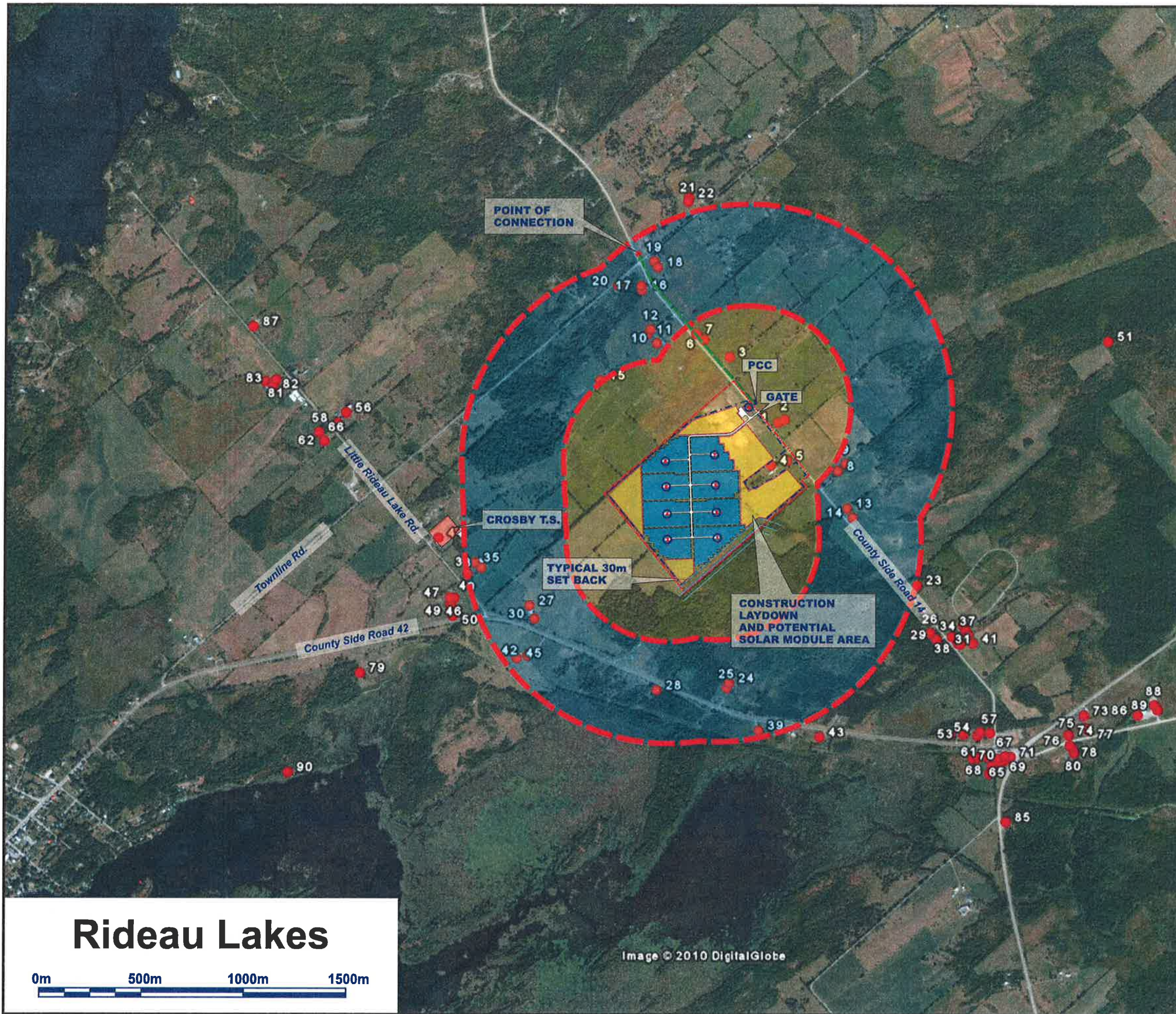







Hatch Ltd. 2010g. Rideau Lakes Solar Project – Construction Plan Report. Prepared for Northland Power Solar Rideau Lakes L.P. 2010.

Appendix A

Site Layout



LEGEND:

-  GRAVEL ACCESS ROAD
-  GATE
-  OVERHEAD 44 kV LINE
-  OVERHEAD 44 kV LINE BY HYDRO ONE
-  PERMANENT SECURITY FENCE PROPERTY BOUNDARY
-  CULVERT
-  AVAILABLE AREA BOUNDARY & PROPERTY SETBACK @ 10 m (CONSTRUCTION SILT FENCE)
-  CONSTRUCTION LAYDOWN AND POTENTIAL SOLAR MODULE AREA
-  500 m RADIUS FROM NOISE SOURCES
-  1 km RADIUS FROM NOISE SOURCES
-  PCC (POINT OF COMMON COUPLING)
-  POINT OF CONNECTION
-  163 RACKS IN ONE GROUP, 3 STRINGS OF 11 PANELS PER RACK (SET @ 30° TILT WITH 7.6 METERS SPACING) 42,900 PANELS REQUIRED, AND 43,032 PANELS USED FOR LAYOUT. NOMINAL CAPACITY: 12 MW_{DC} OR 10 MW_{AC}
-  NOISE RECEPTOR LOCATION
-  2 x 625 kVA INVERTER
1 x 1250 kVA TRANSFORMER

INVERTER'S TRANSFORMER (UTM Co-ordinate)		
18 T	X (m E)	Y (m N)
P1	398872.08	4946392.22
P2	398836.41	4946383.99
P3	398867.83	4946513.75
P4	398632.16	4946505.52
P5	398863.32	4946642.87
P6	398627.66	4946634.64
P7	398858.28	4946787.18
P8	398623.41	4946756.16

SUBSTATION'S TRANSFORMER (UTM Co-ordinate)		
18 T	X (m E)	Y (m N)
P9	399020.41	4947013.11

**PRELIMINARY LAYOUT
NOT FOR CONSTRUCTION**

GOOGLE SATELLITE MAP
IMAGERY DATE: SEPT 4, 2005

Rideau Lakes



Image © 2010 DigitalGlobe

Appendix B

Typical Equipment Details



Efficient

- Without low-voltage transformer: greater plant efficiency due to direct connection to the medium-voltage grid

Turnkey Delivery

- With medium-voltage transformer and concrete substation for outdoor installation

Optional

- Medium-voltage switchgear systems for a flexible structure of large solar parks
- AC transfer station with measurement

- Medium-voltage transformers for other grid voltages (deviating from 20 kV)

SUNNY CENTRAL for Direct medium-voltage feed-in 800MV / 1000MV / 1250MV

High-performance medium-voltage station

For even more power: Two powerful Sunny Central HE inverters are components of a medium-voltage station (MV) which feeds directly into a shared medium-voltage transformer. In this way, for example, two Sunny Central 630HE inverters are combined into a powerful Sunny Central 1250MV station. The advantage: By removing the need for the low-voltage transformer, the plant operator realizes greater yields and at the same time lower inverter costs. The Sunny Central MV is delivered as a "turnkey" concrete substation for outside installation. On top of that, the Sunny Central MV actively participates in grid management, and thereby fulfils all requirements of the Medium-Voltage Directive valid as of July 2010.

SUNNY CENTRAL 800MV / 1000MV / 1250MV

Technical data	Sunny Central 800MV	Sunny Central 1000MV	Sunny Central 1250MV
Input data			
Nominal DC power	816 kW	1018 kW	1284 kW
Max. DC power	900 kW ¹⁾	1120 kW ¹⁾	1410 kW ¹⁾
MPP voltage range	450 V - 820 V ⁵⁾	450 V - 820 V ⁵⁾	500 V - 820 V ⁵⁾⁷⁾
Max. DC voltage	1000 V	1000 V	1000 V
Max. DC current	1986 A	2484 A	2844 A
Number of DC inputs	(16 + 16) + 4 DCHV	(16 + 16) + 4 DCHV	(16 + 16) + 4 DCHV
Output data			
Nominal AC power @ 45 °C	800 kVA	1000 kVA	1250 kVA
Continuous AC power @ 25 °C	880 kVA	1100 kVA	1400 kVA
Nominal AC voltage	20000 V	20000 V	20000 V
Nominal AC current	23.2 A	28.8 A	36.1 A
AC grid frequency 50 Hz	●	●	●
AC grid frequency 60 Hz	●	●	●
Power factor (cos φ)	0.9 leading ... 0.9 lagging		
Max. THD	< 3 %	< 3 %	< 3 %
Power consumption			
Internal consumption in operation	< 3000 W ⁴⁾	< 3000 W ⁴⁾	< 3000 W ⁴⁾
Standby consumption	< 180 W + 1100 W	< 180 W + 1100 W	< 180 W + 1350 W
External auxiliary supply voltage	3 x 230 V, 50/60 Hz	3 x 230 V, 50/60 Hz	3 x 230 V, 50/60 Hz
External back-up fuse for auxiliary supply	B 20 A, 3-pole	B 20 A, 3-pole	B 20 A, 3-pole
Dimensions and weight			
Height	3620 mm	3620 mm	3620 mm
Width	5400 mm	5400 mm	5400 mm
Depth	3000 mm	3000 mm	3000 mm
Weight	35000 kg	35000 kg	35000 kg
Efficiency²⁾			
Max. efficiency	97.7 %	97.9 %	97.8 %
Euro-eta	97.3 %	97.5 %	97.4 %
Protection rating and ambient conditions			
Protection rating (as per EN 60529)	IP54	IP54	IP54
Operating temperature range	-20 °C ... +45 °C	-20 °C ... +45 °C	-20 °C ... +45 °C
Rel. humidity	15 % ... 95 %	15 % ... 95 %	15 % ... 95 %
Fresh air consumption	12400 m ³ /h	12400 m ³ /h	12400 m ³ /h
Max. altitude (above sea level)	1000 m	1000 m	1000 m

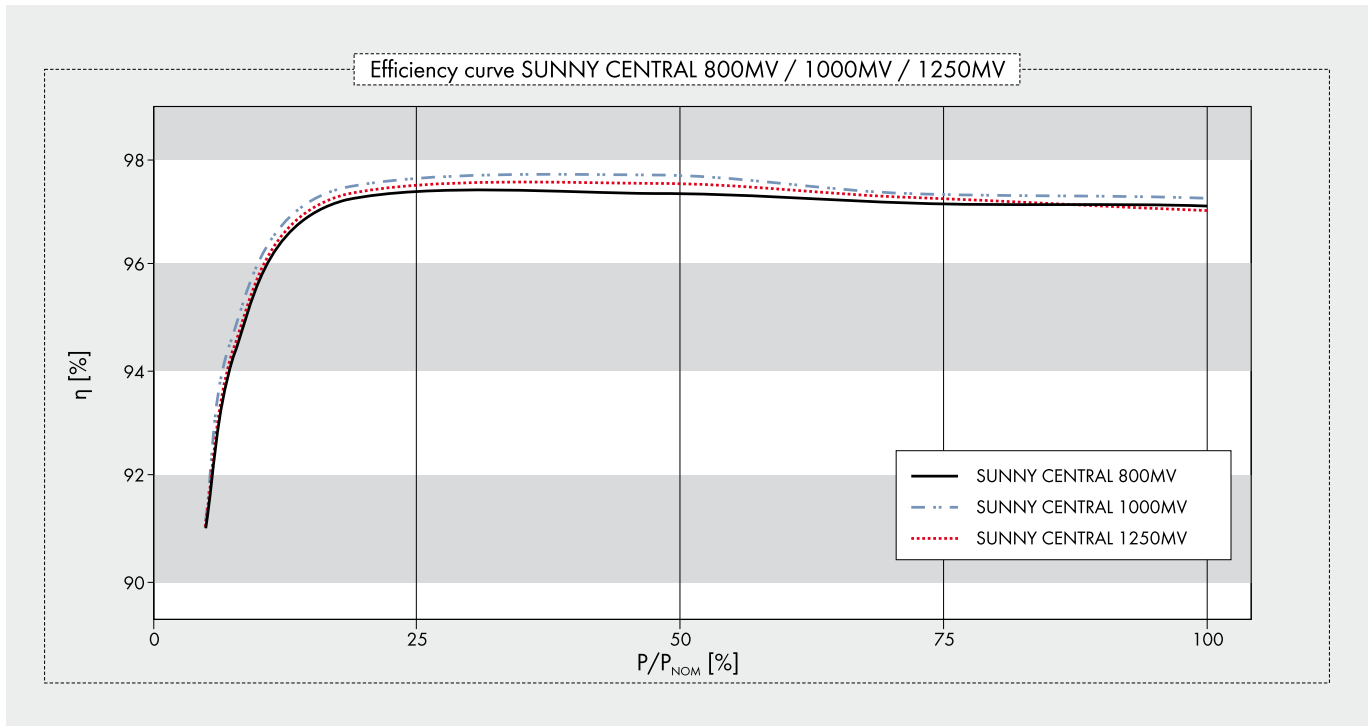

	Sunny Central 800MV	Sunny Central 1000MV	Sunny Central 1250MV
Features			
Display: text line / graphic	●/–	●/–	●/–
Ground fault monitoring	●	●	●
Heating	●	●	●
Emergency stop	●	●	●
Circuit breaker AC side	SI load disconnection switch	SI load disconnection switch	SI load disconnection switch
Circuit breaker DC side	Switch-disconnector with motor	Switch-disconnector with motor	Switch-disconnector with motor
Monitored overvoltage protectors AC / DC	●/●	●/●	●/●
Monitored overvoltage protectors for auxiliary supply	●	●	●
SCC (Sunny Central Control) interfaces			
Communication (NET Piggy-Back, optional)	analog, ISDN, Ethernet	analog, ISDN, Ethernet	analog, ISDN, Ethernet
Analog inputs	10 x A _m ³⁾	10 x A _m ³⁾	10 x A _m ³⁾
Overvoltage protection for analog inputs	○	○	○
Sunny String-Monitor connection (COM1)	RS485	RS485	RS485
PC connection (COM3)	RS232	RS232	RS232
Electrically separated relay (ext. alert signal)	2	2	2
Certificates / listings			
EMC	EN 61000-6-2 EN 61000-6-4		
CE conformity	●	●	●
BDEW-MSRL / FGW / TR8 ⁶⁾	●	●	●
RD 1633 / 2000	●	●	●
Arrêté du 23/04/08	●	●	●
● standard features ○ optional features – not available			
Type designation	SC 800MV-11	SC 1000MV-11	SC 1250MV-11

HE: High Efficiency, inverter without galvanic isolation for connection to a medium-voltage transformer (taking into account the SMA specification for the transformer)

1) Specifications apply to irradiation values below STC

2) Efficiency measured without an internal power supply at $U_{DC} = 500\text{ V}$

3) 2x inputs for the external nominal value specification for active power and reactive power, 1x external alarm input, 1x irradiation sensor, 1x pyranometer

4) Internal consumption at nominal power

5) At $1.05 U_{AC, nom}$ and $\cos \varphi = 1$

6) With limited dynamic grid support

7) At $f_{grid} = 60\text{ Hz}$: 510 V - 820 V

Please note: in certain countries the substations may differ from the substations shown in the images

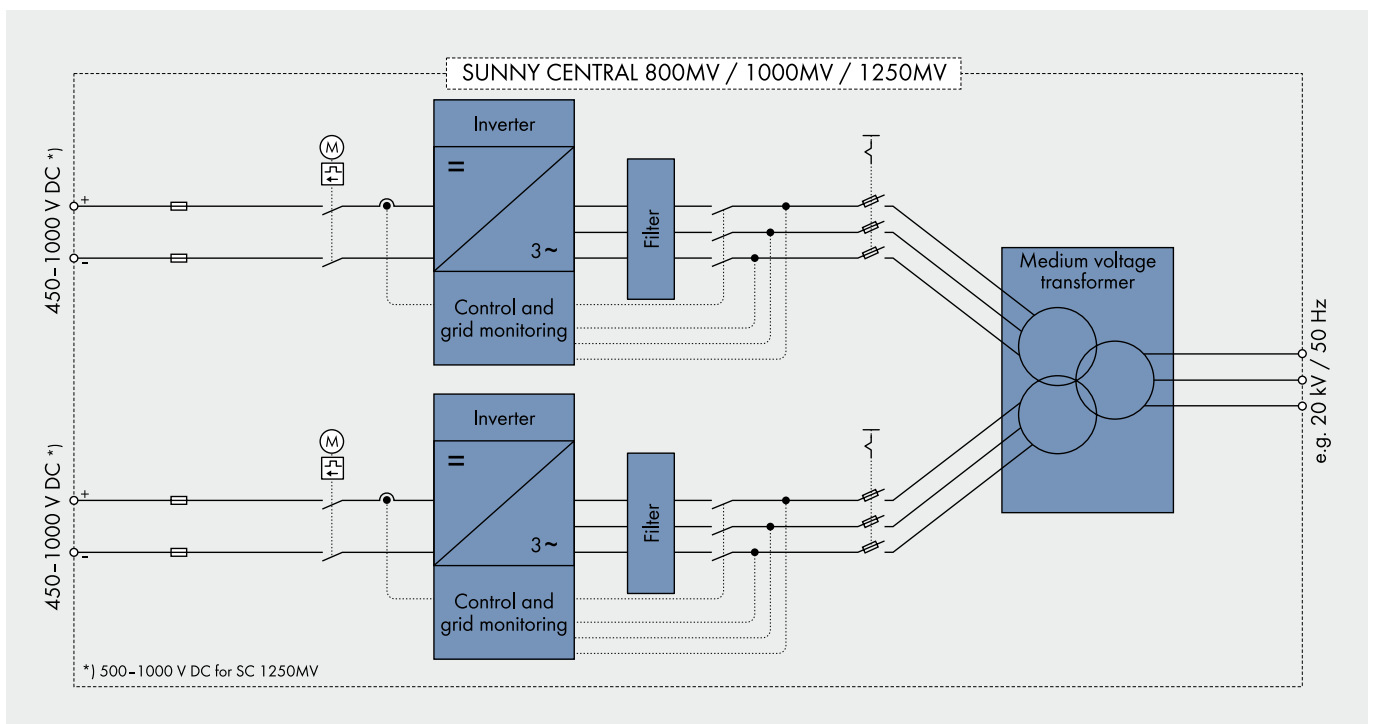

POWERFUL GRID MANAGEMENT FUNCTIONS

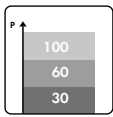

Remote controlled power reduction in case of grid overload

In order to avoid short-term grid overload, the grid operator presets a nominal active power value which the inverter will implement within 60 seconds. The nominal value is transmitted to the inverters via a ripple control receiver in combination with the SMA Power Reducer Box. Typical limit values are 100, 60, 30 or 0 per cent of the nominal power.

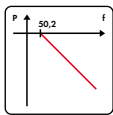

Frequency-dependent control of active power

As of a grid frequency of 50.2 Hz, the inverter automatically reduces the fed-in of active power according to a definable characteristic curve which thereby contributes to the stabilization of the grid frequency.

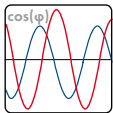

Static voltage support based on reactive power

To stabilize the grid voltage, SMA inverters feed reactive power (leading or lagging) into the grid. Three different modes are available:

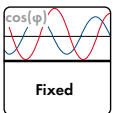

a) Fixed definition of the reactive power by the grid operator

The grid operator defines a fixed reactive power value or a fixed displacement factor between $\cos(\varphi)_{\text{leading}} = 0.90$ and $\cos(\varphi)_{\text{lagging}} = 0.90$.

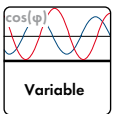

b) Definition of a dynamic setpoint of the reactive power by the utility operator

The grid operator defines a dynamic displacement factor - any value between $\cos(\varphi)_{\text{leading}} = 0.90$ and $\cos(\varphi)_{\text{lagging}} = 0.90$. It is transmitted either through a communication unit the evaluation can e.g. be evaluated and processed by the SMA Power Reducer Box.

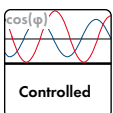

c) Control of the reactive power over a characteristic curve

The reactive power or the phase shift is controlled by a pre-defined characteristic curve - depending on the active power fed into the grid or the grid voltage.

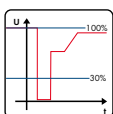

Limited Dynamic Grid Support

The inverter continues to feed to the grid after short term voltage drops - as long as the grid voltage is within a defined voltage window.

SMA Solar Technologie Umrichteranlage Sunny Central SC 1000MV
 Betrieb bei Nennleistung und 50 Hz; 1000 KW

A - bewerteter Schalleistungspegel LwA re 1 pW [dB(A)]

IPK

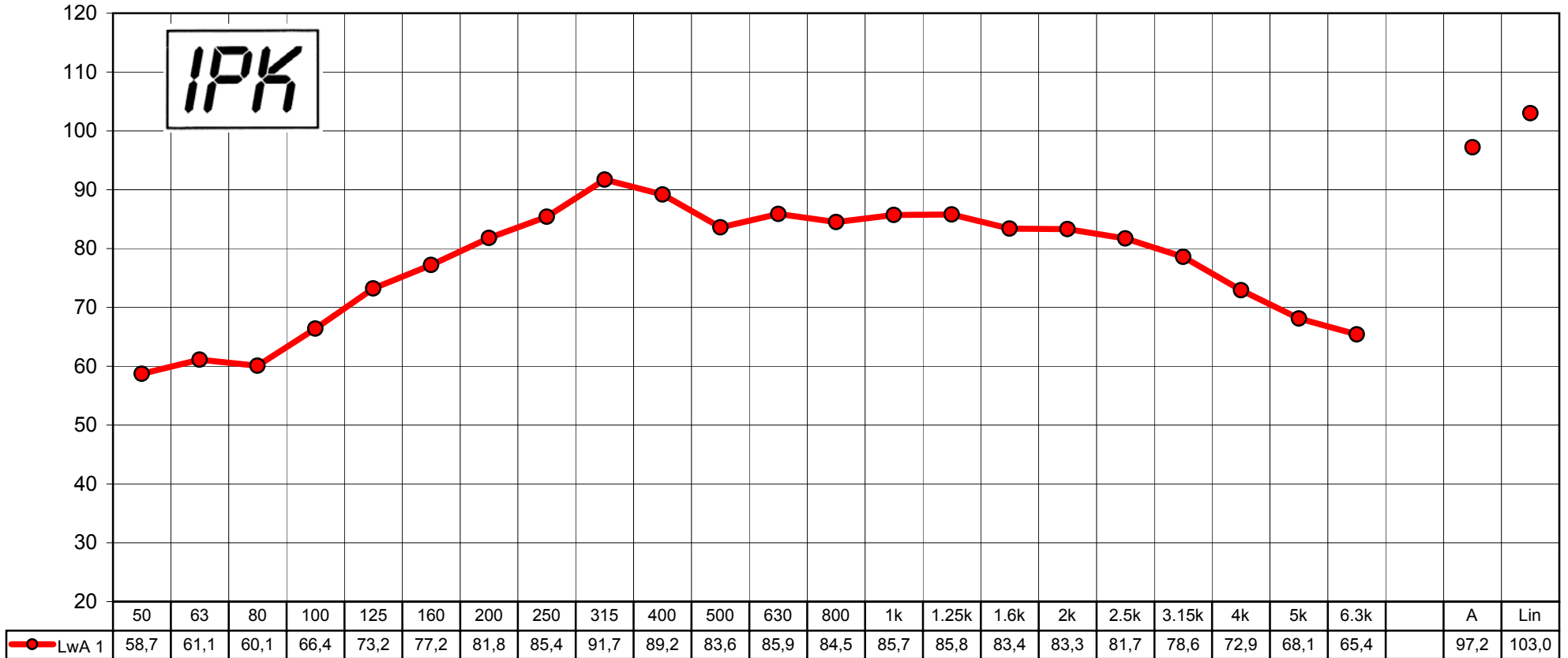

Terz - Mittenfrequenz [Hz]

From: Janos Rajda [mailto:Janos.Rajda@sma-america.com]
Sent: Monday, October 18, 2010 9:38 AM
To: Moran, Joaquin
Cc: Mike Lord; Chris Rytel; Elie Nasr
Subject: RE: Noise Levels - U R G E N T

Hi Joaquin,

Yes it will apply as two (2) 625kW, 60Hz are complete mechanical equivalents to two (2) 500kW, 50Hz or to a 1000kW 2-units system. The slight electrical difference between the two units relate to minimum DC voltage rating and grid frequency the units are connected to with no significant impact on levels of unit parts audio noise generation.

Regards,

Janos

From: Moran, Joaquin [mailto:JMoran@Hatch.ca]
Sent: October-18-10 9:13 AM
To: Janos Rajda
Cc: Mike Lord; Chris Rytel; Elie Nasr
Subject: RE: Noise Levels - U R G E N T

Hi Janos,

Thanks for the information. Just to clarify, the sound power levels provided seem to be for a 1000 kW unit, 50 Hz. Will these apply to the units to be deployed in this case (625 kW, 60 Hz)?

Cheers,

Joaquin

Joaquin E. Moran
Tel. +1 905 374-0701 x 5236

From: Janos Rajda [mailto:Janos.Rajda@sma-america.com]
Sent: Sunday, October 17, 2010 11:22 PM
To: Moran, Joaquin
Cc: Mike Lord; Chris Rytel; Elie Nasr
Subject: RE: Noise Levels - U R G E N T

Hi Joaquin,

Over the weekend we obtained third octave sound power levels for 100% or rated loading case for two SC units as supplied at the time for FirstSolar project in Sarnia.

Thanks again for providing as with sample data, which proved to be helpful in communicating the sound power level format requirement.

Best regards,

Janos

STP280 - 24/Vd STP275 - 24/Vd

280 Watt POLYCRYSTALLINE SOLAR MODULE

Features

- 

High module conversion efficiency (up to 14.4%), through superior manufacturing technology
- 

Guaranteed 0-5W positive power output tolerance ensures high reliability
- 

Three bus-bar design enhances cell reliability and reduces series resistance for large fill factor
- 

Excellent performance under low light environments (mornings, evenings and cloudy days)
- 

Entire module certified to withstand high wind loads (2400 Pascal) and snow loads (5400 Pascal) *
- 

4.0mm thick tempered glass improves module durability



Trust Suntech to Deliver Reliable Performance Over Time

- World's leading manufacturer of crystalline silicon photovoltaic modules
- Unrivaled manufacturing capacity and world-class technology
- Rigorous quality control meeting the highest international standards : ISO 9001: 2008 and ISO 14001: 2004
- Certification and standards: IEC 61215, IEC 61730, conformity to CE

Industry-leading warranty

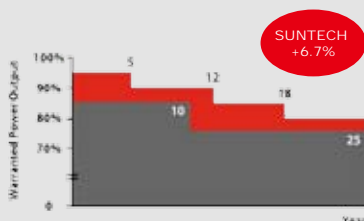

- 25 year transferrable power output warranty: 5 year/95%, 12 year/90%, 18 year/85%, 25 year/80% **
- Based on nominal power
- Warrants 6.7% more power than the market standard over 25 years
- 5 year material and workmanship warranty

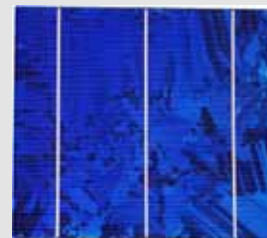

Textured surface and silicon nitride anti-reflection coating improves light absorption for more current production



Suntech's reputation is founded on more than 1.5 gigawatts of high-performing solar modules installed around the world

* Please refer to Suntech Standard Module Installation Manual for details.
** Please refer to Suntech Product Warranty for details.

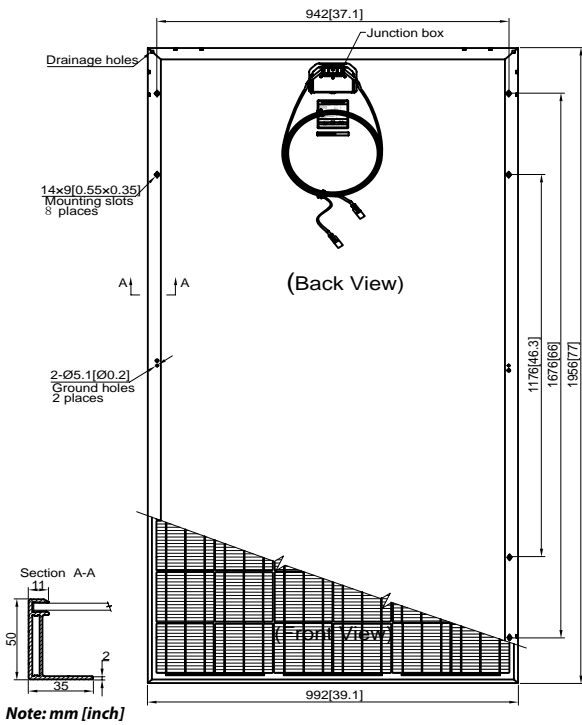

Current-Voltage & Power-Voltage Curve (280-24)

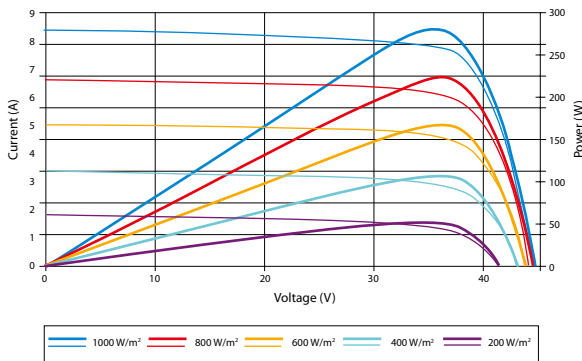

Temperature Characteristics

Nominal Operating Cell Temperature (NOCT)	45±2°C
Temperature Coefficient of Pmax	-0.47 %/°C
Temperature Coefficient of Voc	-0.34 %/°C
Temperature Coefficient of Isc	0.045 %/°C



Electrical Characteristics

STC	STP280-24/Vd	STP275-24/Vd
Optimum Operating Voltage (Vmp)	35.2 V	35.1 V
Optimum Operating Current (Imp)	7.95 A	7.84 A
Open - Circuit Voltage (Voc)	44.8 V	44.7 V
Short - Circuit Current (Isc)	8.33 A	8.26 A
Maximum Power at STC (Pmax)	280 W	275 W
Module Efficiency	14.4%	14.2%
Operating Temperature	-40 °C to +85 °C	-40°C to +85°C
Maximum System Voltage	600 V DC	600 V DC
Maximum Series Fuse Rating	20 A	20 A
Power Tolerance	0/+5 W	0/+5 W

STC: Irradiance 1000 W/m², module temperature 25 °C, AM=1.5

NOCT	STP280-24/Vd	STP275-24/Vd
Maximum Power (W)	204 W	201 W
Maximum Power Voltage (V)	32.0 V	31.9 V
Maximum Power Current (A)	6.39 A	6.29 A
Open Circuit Voltage (Voc)	40.8 V	40.7 V
Short Circuit Current (Isc)	6.74 A	6.68 A
Efficiency Reduction (from 1000 W/m² to 200 W/m²)	<4.5%	<4.5%

NOCT: Irradiance 800 W/m², ambient temperature 20 °C, wind speed 1 m/s

Mechanical Characteristics

Solar Cell	Polycrystalline 156 × 156 mm (6 inches)
No. of Cells	72 (6 × 12)
Dimensions	1956 × 992 × 50 mm (77.0 × 39.1 × 2.0 inches)
Weight	27 kgs (59.5 lbs.)
Front Glass	4.0 mm (0.16 inches) tempered glass
Frame	Anodized aluminium alloy
Junction Box	IP67 rated
Output Cables	H+S RADOX® SMART cable 4.0 mm² (0.006 inches²), symmetrical lengths (-) 1100 mm (43.3 inches) and (+) 1100 mm (43.3 inches), H4 connectors (MC4 compatible)

Packing Configuration

Container	20' GP	40' GP	40' HC
Pieces per pallet	21	21	21
Pallets per container	6	12	24
Pieces per container	126	252	504

Specifications are subject to change without further notification

