



**NORTHLAND  
POWER**

# Belleville South Solar Project

## Noise Assessment Report

August 15, 2011



Northland Power Inc.  
on behalf of  
Northland Power Solar  
Belleville South L.P.  
Toronto, Ontario

## Noise Assessment Report

### Belleville South Solar Project

H334844-0000-07-124-0045

Rev. 1

August 15, 2011

#### **Disclaimer**

This report has been prepared by or on behalf of Northland Power Inc. for submission to the Ontario Ministry of the Environment as part of the Renewable Energy Approval process. The content of this report is not intended for the use of, nor is it intended to be relied upon by, any other person. Neither Northland Power Inc. nor any of its directors, officers, employees, agents or consultants has any liability whatsoever for any loss, damage or injury suffered by any third party arising out of, or in connection with, their use of this report.

Project Report

August 15, 2011

**Northland Power Inc.  
Belleville South Solar Project**

## **Noise Assessment Report**

Blank back

## Executive Summary

This report presents the results of the noise assessment study required for Solar Facilities under Regulation 359/09, as part of the Renewable Energy Approval (REA) Process.

Northland Power Solar Belleville South L.P. (hereinafter referred to as “Northland”) has retained Hatch Ltd. (Hatch) to prepare a Noise Assessment Study for the Northland Power Belleville South Solar-Photovoltaic facility (hereinafter referred to as the “Project”), with an installed capacity of 10 MW. The Project will be located within the City of Prince Edward County, Ontario.

This Noise Assessment Study has been prepared based on the document entitled “Basic Comprehensive Certificates of Approval (Air) – User Guide” by the Ontario Ministry of the Environment (MOE). The sound pressure levels at the points of reception (POR) have been estimated using ISO 9613-2, implemented in the CADNA-A computer code. The performance limits used for verification of compliance correspond to the values for rural areas (45 dBA for day time, 40 dBA for night time). The results presented in this report are based on the best available information at this time. It is the intention that, in the detailed engineering phase of the project, certified noise data based on final plans and designs will confirm the conclusions of this noise study.

Based on the results obtained in this study, we believe that the sound pressure levels at POR will not exceed MOE requirements for rural areas. Any noise issues that might arise during commissioning will be manageable and can be resolved by implementing typical remediation measures as described in this report. It is our intention to verify by field measurements taken on completion of installation and during commissioning that the noise levels at the POR are within the limits set by the MOE.

Blank back

## Table of Contents

<b>1. Introduction .....</b>	<b>1</b>
<b>2. Facility Description .....</b>	<b>1</b>
2.1 Site Location .....	1
2.2 Acoustical Environment .....	3
2.3 Life of Project.....	3
2.4 Operating Hours .....	3
2.5 Approach to the Study.....	3
<b>3. Noise Source Summary .....</b>	<b>3</b>
3.1 Substation .....	3
3.2 Inverter Clusters (Pads).....	4
3.3 Noise Summary Table.....	4
<b>4. Point of Reception Summary .....</b>	<b>5</b>
<b>5. Impact Assessment .....</b>	<b>6</b>
5.1 Compliance With Performance Limits .....	6
<b>6. Mitigation Measures.....</b>	<b>7</b>
<b>7. Conclusions and Recommendations .....</b>	<b>7</b>
<b>8. References.....</b>	<b>7</b>
<b>Appendix A</b>	<b>Land-Use Zoning Designation Plan, Area Location Plan and Plant Layout</b>
<b>Appendix B</b>	<b>Noise Sources</b>
<b>Appendix C</b>	<b>Sound Pressure Levels for Points of Reception, Noise Maps from CADNA-A</b>

## List of Tables

Table 2.1	General Project Description .....	1
Table 3.1	Noise Source Summary .....	5
Table 4.1	Point of Reception Noise Impact (Day Time) .....	5
Table 5.1	Performance Limits (One-Hour $L_{eq}$ ) by Time of Day for Class 3 Areas .....	6
Table 5.2	Acoustic Assessment Summary (Day and Night Time) .....	6
Table 6.1	Barrier Description .....	7

## List of Figures

Figure 2.1	Project Location .....	2
------------	------------------------	---



## 1. Introduction

This report presents the results of the noise assessment study required for Solar Facilities under Regulation 359/09, as part of the Renewable Energy Approval (REA) Process.

Northland Power Solar Belleville South L.P. (hereinafter referred to as “Northland”) retained Hatch Ltd. (Hatch) to prepare a Noise Assessment Study for the Northland Power Belleville South Solar-Photovoltaic (Solar PV) facility (hereinafter referred to as the “Project”, with an installed capacity of 10 MW. The Project will be located within the City of Prince Edward County, Ontario.

The report was prepared according to publication “Basic Comprehensive Certificates of Approval (Air) – User Guide, 2004” by the Ministry of the Environment (MOE), and includes a general description of the facility, sources and points of reception (POR), assessment of compliance, as well as all the supporting information relevant to the Project.

## 2. Facility Description

The Project will utilize photovoltaic (PV) panels installed on fixed racking structures, mounted on the ground. The PV panels generate DC electricity, which is converted to 560-V AC electricity by clusters of inverters. The 560-V power is transformed to 13.8 kV by a transformer located at each inverter cluster. The 13.8-kV power is brought to a single central substation transformer to be stepped up to 44 kV for transmission away from the site.

Since the panels will be ground-mounted and the total nameplate capacity is over 10 kW, the Project is considered to be a Class 3 Solar Facility, according to the classification presented in Regulation 359/09.

A general description of the Project is provided in Table 2.1.

**Table 2.1 General Project Description**

Project Description	Ground-mounted Solar PV, Class 3
System Nameplate Capacity	10 MW AC/10 MVA
Local Distribution Company	Hydro One Networks Inc.
Approximate Coordinates	Latitude 44.062786° N, Longitude 77.314895° W

### 2.1 Site Location

The property consists of agricultural land totalling more than 42 hectares, located about 15 km northwest of Picton, in the Township of Sophiasburg. Figure 2.1 shows the geographical location of the Project. The detailed scaled Zoning Designation Plan and Area Location Plan drawings are included in Appendix A. A total of about 50 receptors are located within 1 km from the proposed substation.

For modelling purposes, the vegetation that blocks some of the POR from the sources has not been incorporated, so the predicted sound levels at these locations may be slightly over predicted.

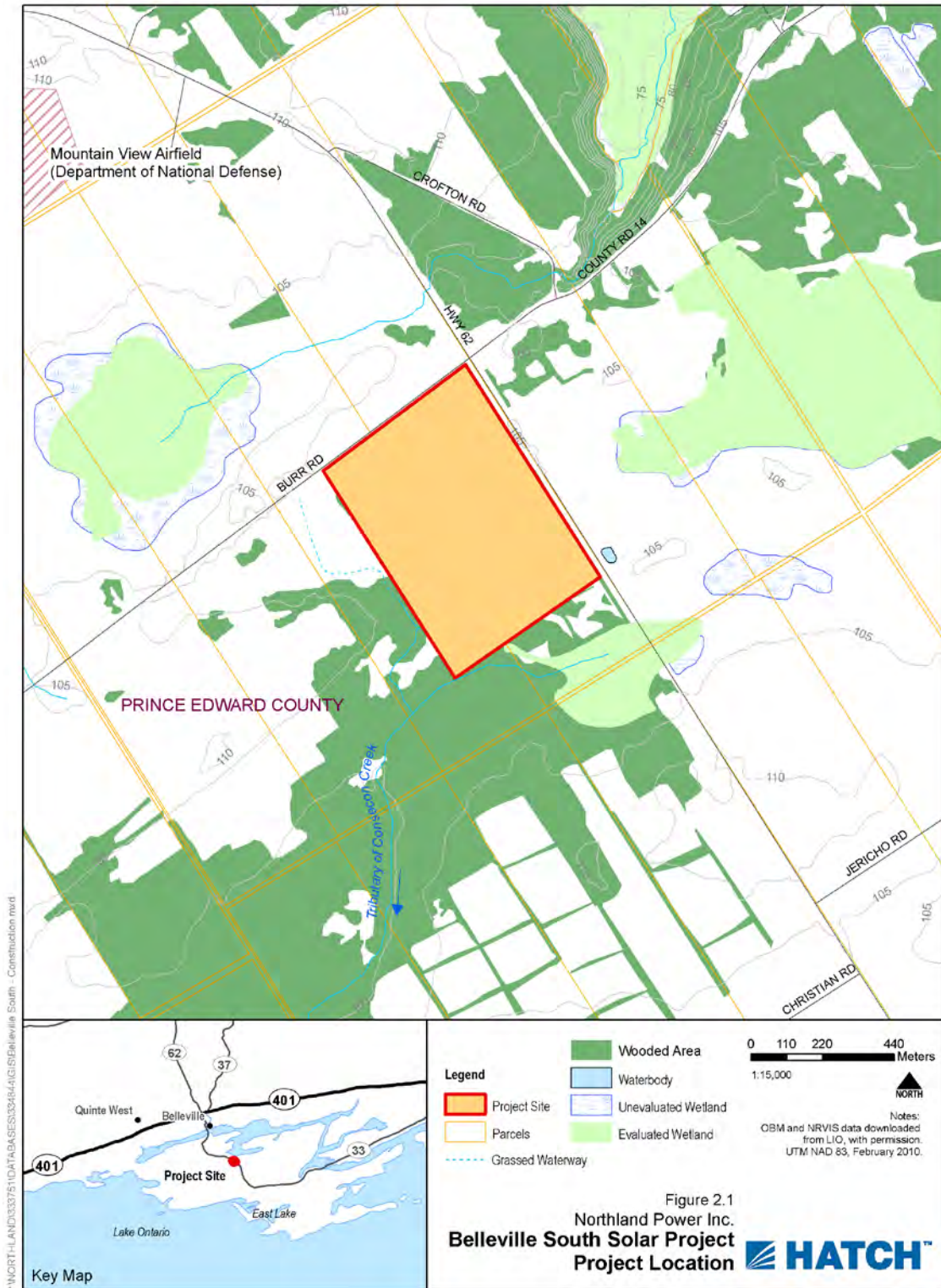

Figure 2.1 Project Location

## 2.2 Acoustical Environment

The Project will be surrounded by farmland, with some heavily forested areas to the south. Some traffic noise is expected from Highway 62 and Burr Road, mainly during day hours. Also, aircraft noise is expected in the area, due to the Mountain View Airfield (Department of National Defence) located 1 km north from the site. Mineral extraction operations performed in a quarry 3 km northwest of the site may also contribute significantly to the background sound levels of the area. The traffic volumes can also be affected by material transportation from/to the quarry.

The background noise levels are expected to be typical of rural areas, classified as a Class 3 based on Publication NPC-232 by the MOE.

## 2.3 Life of Project

The expected life of the Project is 30 years. The manufacturer's warranty on the PV modules is 25 years and the expected life of solar power plants of this type is 35 to 40 years.

## 2.4 Operating Hours

Solar PV facilities produce electricity during the day hours, when the sun's rays are collected by the panels. After sunset, the plant will not receive solar radiation to generate any electricity. Under these conditions, the inverters will not produce noise and the transformers will be energized, but not in operation (no fans).

## 2.5 Approach to the Study

The sound pressure levels at the POR were predicted using procedures from ISO 9613-2, which is a widely used standard for evaluation of noise impact in environmental assessments. The sound power levels were estimated from the National Electrical Manufacturers Association (NEMA) standards for the substation transformer. The inverter manufacturer provided the noise data for the inverter clusters, which includes the medium-voltage transformer. The software package CADNA-A, which implements ISO-9613-2, was used to predict the noise levels at the closest POR. This numerical modelling software is able to handle the sound sources present in the Project, as well as considering atmospheric and ground attenuation. The height contours for the site were taken from the Ontario Base Maps (OBM).

# 3. Noise Source Summary

The main sources of noise from the Project will be the step-up transformer, located at the substation, and eight inverter clusters which also include medium-voltage transformers. Cogeneration Associates Limited provided a layout of the solar PV facility (see Figure A3, Appendix A). The coordinates of each source are presented in Appendix B.

## 3.1 Substation

At this point, it is anticipated that the step-up power transformer located in the substation will have a capacity of 10 MVA. In addition, the transformer will be oil-filled with air-forced cooling (ONAF). For the purpose of evaluating the potential noise impacts of the transformer, the sound power level was estimated using data from NEMA TR1-1993 (2000). This standard provides maximum sound

level values for transformers, and manufacturers routinely meet this specification. Hence, the results based on NEMA slightly overestimate the impact on POR. The NEMA levels were then converted into frequency spectra using empirical correlations for transformer noise (Harris, 1998).

Power transformers are considered by the MOE to be tonal noise sources. A 5-dBA penalty will be added to the sound power spectrum, as recommended by Publication NPC-104, "Sound Level Adjustments," for tonality. Table B2, Appendix B, shows the frequency spectrum used to model the substation transformer.

### **3.2 Inverter Clusters (Pads)**

At this stage of the Project, Northland is planning to use inverter clusters manufactured by SMA. Each Sunny Central SC1250MV unit comprises two 630HE inverters (630 kW), contained in an e-house or enclosure (see Appendix B). The main sources of noise are the cooling/ventilation fans for the inverters, the electrical components on the inverters and the medium-voltage transformer.

The installed capacity of each inverter cluster is 1.25 MW, as shown in Table 3.1. SMA provided third-octave noise data for the inverter cluster unit, which includes the medium-voltage transformer (see Appendix B). A 5-dBA penalty was added to the frequency spectrum, as stipulated in Publication NPC-104, "Sound Level Adjustments," to allow for tonality. The frequency spectra used for the inverter clusters and medium-voltage transformers is shown in Table B2, Appendix B.

The "barrier effect" provided by the solar panels surrounding the inverter clusters has not been modelled, which means that the sound pressure levels predicted at the POR can be higher than would be the case if the barrier was accounted for. Note also that, at night time, the facility will not operate. Under these conditions, the inverters do not produce noise. The medium-voltage transformers are energized and make some magnetostrictive noise at a reduced level, but no cooling fans are in operation. Since the noise data provided by SMA combines both inverter and transformer, the model will assume that the cluster will be operating 24 hours.

### **3.3 Noise Summary Table**

A summary of the sound sources described above, including sound level, characteristics and potential noise control measures, is presented in Table 3.1.

**Table 3.1 Noise Source Summary**

Source ID	Source Description	Overall Sound Power Level (dBA)	Source Location	Sound Characteristics	Noise Control Measures
1	Subs. Transformer: 10 MVA	93.3	O	S-T	B
2	Inverter Cluster #1: 1.25 MW	102.2	O	S-T	E,S
3	Inverter Cluster #2: 1.25 MW	102.2	O	S-T	E,S
4	Inverter Cluster #3: 1.25 MW	102.2	O	S-T	E,S
5	Inverter Cluster #4: 1.25 MW	102.2	O	S-T	E,S
6	Inverter Cluster #5: 1.25 MW	102.2	O	S-T	E,S
7	Inverter Cluster #6: 1.25 MW	102.2	O	S-T	E,S
8	Inverter Cluster #7: 1.25 MW	102.2	O	S-T	E,S
9	Inverter Cluster #8: 1.25 MW	102.2	O	S-T	E,S

**Notes:**

1. A 5-dBA penalty is included in this table.
2. Location: Inside building (I), Outside building (O).
3. Sound Characteristics: Steady (S), Tonal (T), Impulsive (I), Quasi-Steady Impulsive (QSI).
4. Noise Control: Silencer (S), Acoustic lining (A), Barrier (B), Lagging (L), Enclosure (E), Other (O), Uncontrolled (U).

## 4. Point of Reception Summary

The POR used in this study have been taken from the OBM for the Belleville area. Some additional receptors (residential buildings) were added based on satellite imagery from Google Earth Pro (2002). The total number of POR within a 1-km radius from the substation is 50 (see Figure A2). Three of these receptors have been chosen as representative for evaluating the noise impact from the facility, and are presented in Table 4.1 (see Figure A2 in Appendix A). The complete set of results is included in Appendix C, including a noise map from CADNA-A. For this study, the elevation above ground of the POR is 4.5 m.

**Table 4.1 Point of Reception Noise Impact (Day Time)**

Source ID	POR 1		POR 9		POR 14	
	Distance (m)	Leq Sound Level at POR 1 (dBA)	Distance (m)	Leq Sound Level at POR 9 (dBA)	Distance (m)	Leq Sound Level at POR 14 (dBA)
1	159	37.3	217	35.2	277	33.0
2	432	22.2	316	28.2	463	24.8
3	410	22.7	396	26.2	244	30.3
4	548	19.7	439	25.3	510	24.0
5	530	20.0	498	24.2	322	28.0
6	665	17.7	583	22.7	520	23.8
7	683	17.4	663	21.5	397	26.2
8	814	15.7	740	20.5	615	22.2
9	784	16.0	760	20.2	487	24.4

## 5. Impact Assessment

The purpose of the acoustic assessment report is to demonstrate that the facility is in compliance with the noise performance limits. The Project will be located in a Class 3 Area, based on the classification defined in Publication NPC-232 by the MOE. Class 3 area means a rural area with an acoustical environment that is dominated by natural sounds, having little or no traffic, such as an agricultural area.

Table 5.1 shows the performance limits set by the MOE for Class 3 Areas, according to Publication NPC-232.

**Table 5.1 Performance Limits (One-Hour  $L_{eq}$ ) by Time of Day for Class 3 Areas**

Time of Day	One Hour $L_{eq}$ (dBA)
	Class 3 Area
07:00 to 19:00	45
19:00 to 23:00	40
23:00 to 07:00	40

The Project will be operating during the day hours, that is, before 19:00 during most of the year. However, in the summer months, the sun may shine until past 21:00, although the inverters will be well below 100% loading conditions. This means that during the summer the Project will be operating at the time the applicable performance limit changes from 45 dBA to 40 dBA. At night time, the transformer is still energized, so the resultant sound pressure levels should be compared to the lower limit of 40 dBA. Note that since the frequency spectrum provided by the manufacturer includes the inverters and medium-voltage transformer at 100% loading conditions, it is assumed that both devices are operating during 24 hours. In reality, the only sound that could be perceived at night time is the magnetostrictive noise from the transformers.

For this study, the overall ground attenuation coefficient was assumed to be 0.7, which is commonly used by the MOE for evaluating the noise impact of other renewable energy facilities.

### 5.1 Compliance With Performance Limits

Table 5.2 presents the predicted sound pressure levels for the representative POR. The complete set of results is included in Appendix C.

**Table 5.2 Acoustic Assessment Summary (Day and Night Time)**

POR ID	POR Description	Sound Level at POR ( $L_{eq}$ ) Day / Night (dBA)	Verified by Acoustic Audit (Yes/No)	Performance Limit ( $L_{eq}$ ) Day / Night (dBA)	Compliance With Performance Limit (Yes/No)
1	House – North	37.8/37.8	No	45.0/40.0	Yes
9	House – Northwest	37.4/37.4	No	45.0/40.0	Yes
14	House – East	37.3/37.3	No	45.0/40.0	Yes

The results show that all POR are compliant with MOE guidelines based on the performance limits.

## 6. Mitigation Measures

Mitigation for operation of the Project has been modelled and shown to be feasible in the form of acoustic barriers for the substation, and enclosures with acoustical louvers for all inverters. The proposed considerations for these devices must be revisited when the specific dimensions and configuration of the enclosure are made available by the manufacturer.

The minimum construction requirements for the proposed noise barrier located next to the substation are presented in Table 6.1, as well as the approximate dimensions. Figure B1 and Table B3 in Appendix B present a diagram of the barrier design and the absorption coefficients used in the noise model. The noise reduction and sound transmission characteristics of the acoustical louvers considered in this report are presented in Table B4, Appendix B.

**Table 6.1 Barrier Description**

Mitigation ID	Location	Construction Requirements	Approximate Height (m)	Approximate Length (m)	Distance From Source (m)
BarrierS1	See Figure B1	20 kg/m <sup>2</sup> , continuous	4.0	5.0	1.5
BarrierS2	See Figure B1	20 kg/m <sup>2</sup> , continuous	4.0	5.0	1.5

While analysis indicates that no additional mitigation will be required, the noise levels will be verified at the closest POR after the Project goes into service. If measurements indicate a need to further reduce sound levels to satisfy MOE criteria, additional mitigation measures will be taken at the sources.

## 7. Conclusions and Recommendations

For the Project, the sound pressure levels at the POR have been estimated using the CADNA-A model, based on ISO 9613-2. The performance limits used for comparison correspond to Class 3 areas, with 45 dBA during day time (7:00 a.m. to 7:00 p.m.) and 40 dBA during night time. Mitigation for operation of the Project has been modelled and shown to be feasible.

Based on the results obtained in this study, it is concluded that the sound pressure levels at the POR will be below MOE requirements for Class 3 areas at night time (40 dBA) and day time (45 dBA).

## 8. References

- Harris, C. 1998. *Acoustical Measurements and Noise Control*, Third Edition. Acoustical Society of America.
- IEEE. 2006. C57.12.90-2006: Standard Test Code for Liquid-Immersed, Power and Regulating Transformers. pp 64 to 76.
- Ministry of the Environment (MOE). 1997. *Noise Assessment Criteria in Land Use Planning*. Publication LU-131. Ontario Ministry of the Environment. 12 pp + Annex.

MOE. 1995. Sound Level Limits for Stationary Sources in Class 1 & 2 Areas (Urban). Publication NPC-205. Ontario Ministry of the Environment. 6 pp + Annex.

MOE. 1995. Sound Level Limits for Stationary Sources in Class 3 Areas (Rural). Publication NPC-232. Ontario Ministry of the Environment. 8 pp + Annex.

NEMA. 2000. Standards Publication No. TR 1-1993 (R2000): Transformers, Regulators and Reactors. National Electrical Manufacturers Association. 31 pp.

ISO 1996-1 Description, Measurement and Assessment of Environmental Noise – Part 1: Basic Quantities and Assessment Procedures.



# **Appendix A**

## **Land-Use Zoning Designation Plan, Area Location Plan and Plant Layout**

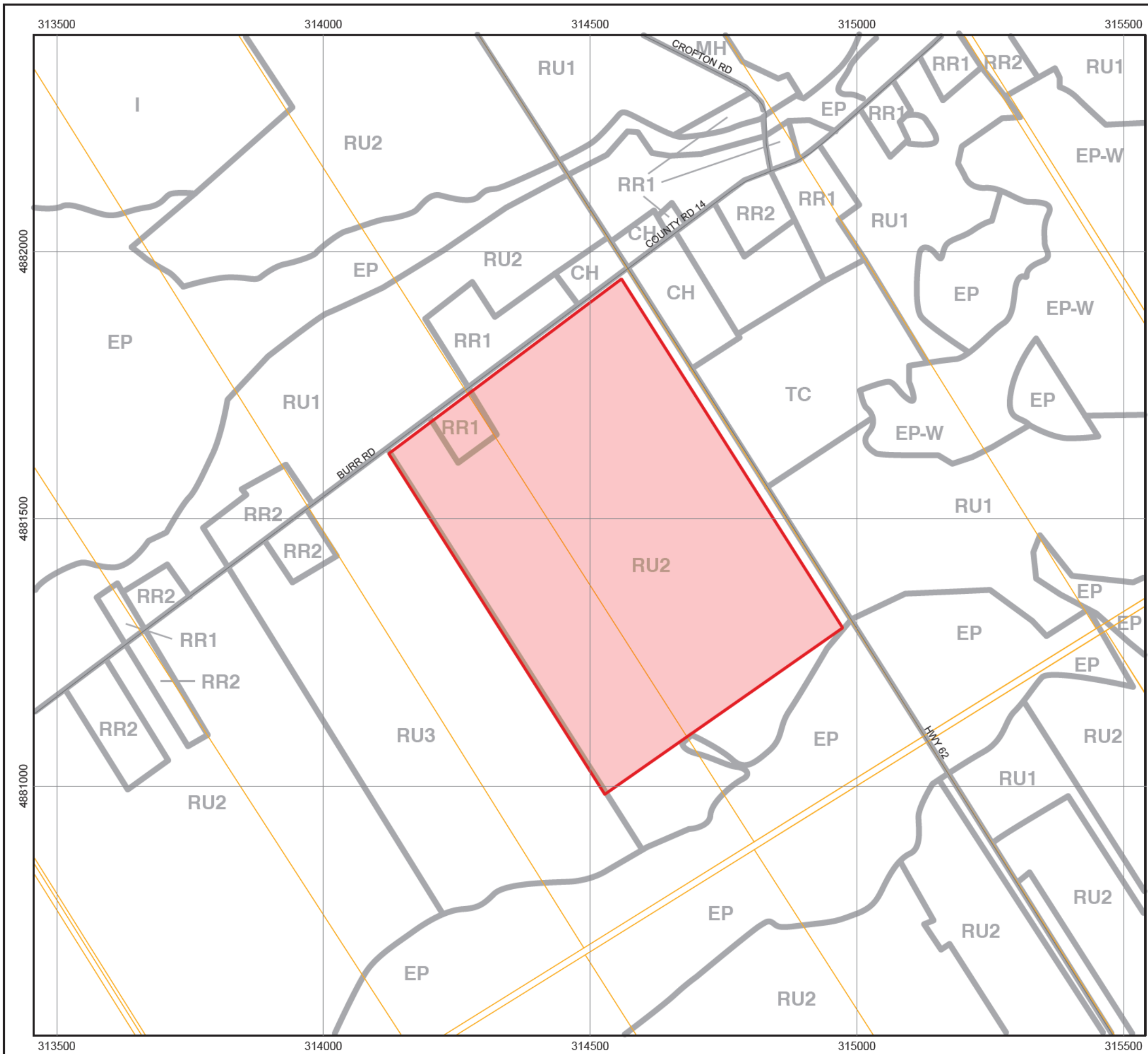

- RU1 Rural 1
- RU3 Rural 3
- RU2 Rural 2
- R1 Urban Residential Type 1
- R2 Urban Residential Type 2
- R3 Urban Residential Type 3
- HR Hamlet Residential
- LSR Limited Service Residential
- MHR Mobile Home Residential
- RR1 Rural Residential 1
- RR2 Rural Residential 2
- CC Core Commercial
- CG General Commercial
- CL Local Commercial
- CH Highway Commercial
- TC Tourist Commercial
- TPC Trailer Park Commercial
- MG General Industrial
- MH Heavy Industrial
- MR Rural Industrial
- MX Extractive Industrial
- MD Waste Disposal Industrial
- I Institutional
- OS Open Space
- EP Environmental Protection
- EP-W Ep - Provincially Significant Wetland
- FD Future Development

Project Site



0 75 150 300 Metres

1:7,500

Source: Zoning By Law for County of Prince Edward, 2006

Northland Power Inc.  
 Belleville South Solar Project  
**Land Use  
 Zoning Designation Plan**



Figure A.1

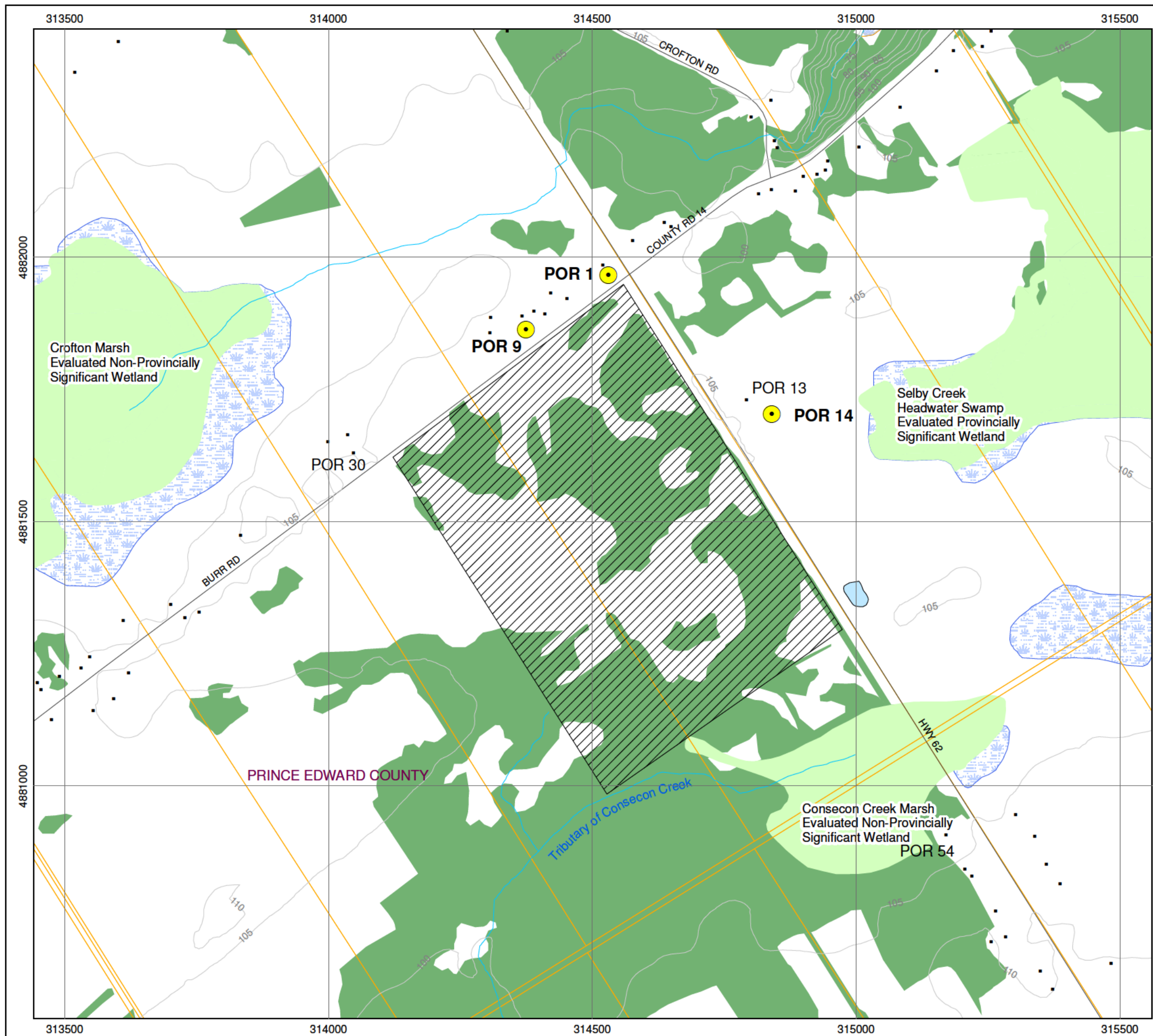

**Legend**

- Building
- Roads
- Topographic Contour (5m interval)
- Watercourse
- ▨ Project Site
- ▭ Parcels
- ▭ Waterbody
- ▨ Unevaluated Wetland
- ▭ Evaluated Wetland
- ▭ Wooded Area



1:7,500

Notes: OBM and NRVIS data downloaded from LIO, with permission. UTM NAD 83, June 2010.

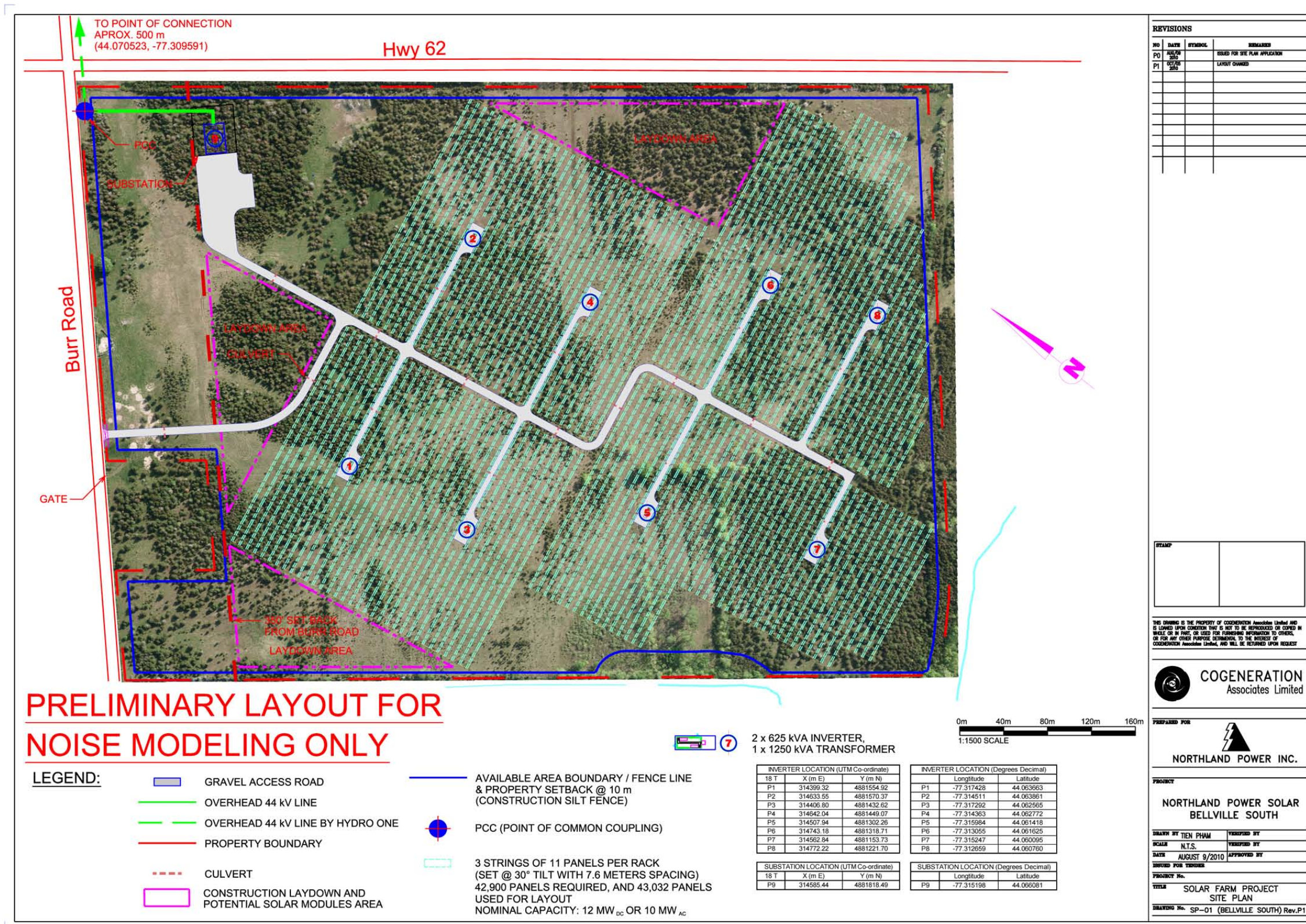

Figure A3 Northland Belleville South Layout (provided by Cogeneration Associates Limited)

# Appendix B

## Noise Sources

**Table B1 Point Sources Used in CADNA-A, Includes Tonality Penalty of 5 dBA**

Name	Result PWL		Correction		Height (m)	Coordinates		
	Day (dBA)	Night (dBA)	Day (dBA)	Night (dBA)		X (m)	Y (m)	Z (m)
Substation – 10 MVA	93.3	93.3	5.0	5.0	3.2	314585	4881818	108.2
Inverter Cluster #1: 1.25 MW	102.2	102.2	5.0	5.0	3.5	314399	4881555	108.5
Inverter Cluster #2: 1.25 MW	102.2	102.2	5.0	5.0	3.5	314634	4881570	108.5
Inverter Cluster #3: 1.25 MW	102.2	102.2	5.0	5.0	3.5	314407	4881433	108.5
Inverter Cluster #4: 1.25 MW	102.2	102.2	5.0	5.0	3.5	314642	4881449	108.5
Inverter Cluster #5: 1.25 MW	102.2	102.2	5.0	5.0	3.5	314508	4881302	108.5
Inverter Cluster #6: 1.25 MW	102.2	102.2	5.0	5.0	3.5	314743	4881319	108.5
Inverter Cluster #7: 1.25 MW	102.2	102.2	5.0	5.0	3.5	314563	4881154	108.5
Inverter Cluster #8: 1.25 MW	102.2	102.2	5.0	5.0	3.5	314772	4881222	108.5

**Table B2 Frequency Spectra Use for Modelling the Noise Sources, Not Including Tonality Penalty**

Name	Octave Spectrum (dBA)										
	31.5	63	125	250	500	1000	2000	4000	8000	A	lin
10-MVA Subs. Transformer	45.5	64.7	76.8	79.3	84.7	81.9	78.1	72.9	63.8	88.3	96.9
Inverter 1.25 MW	4.8	64.8	78.9	93.0	91.6	90.1	87.6	79.9	65.4	97.2	103.7

**Table B3 Absorption Coefficient  $\alpha$  for the Barrier**

Name	Octave Spectrum (dBA)									
	31.5	63	125	250	500	1000	2000	4000	8000	$A_w$
Barrier	0.00	0.00	0.01	0.05	0.05	0.04	0.04	0.04	0.00	0.05

**Table B4 Noise Reduction and Sound Transmission Characteristics of the Acoustical Louvers**

Name	Octave Spectrum (dBA)									
	31.5	63	125	250	500	1000	2000	4000	8000	
Louwer	0.0	0.0	10.0	10.0	12.0	16.0	23.0	18.0	0.0	

Blank back



**Efficient**

- Without low-voltage transformer: greater plant efficiency due to direct connection to the medium-voltage grid

**Turnkey Delivery**

- With medium-voltage transformer and concrete substation for outdoor installation

**Optional**

- Medium-voltage switchgear systems for a flexible structure of large solar parks
- AC transfer station with measurement

- Medium-voltage transformers for other grid voltages (deviating from 20 kV)

**SUNNY CENTRAL for Direct medium-voltage feed-in  
800MV / 1000MV / 1250MV**

High-performance medium-voltage station

For even more power: Two powerful Sunny Central HE inverters are components of a medium-voltage station (MV) which feeds directly into a shared medium-voltage transformer. In this way, for example, two Sunny Central 630HE inverters are combined into a powerful Sunny Central 1250MV station. The advantage: By removing the need for the low-voltage transformer, the plant operator realizes greater yields and at the same time lower inverter costs. The Sunny Central MV is delivered as a "turnkey" concrete substation for outside installation. On top of that, the Sunny Central MV actively participates in grid management, and thereby fulfils all requirements of the Medium-Voltage Directive valid as of July 2010.



# SUNNY CENTRAL 800MV / 1000MV / 1250MV

Technical data	Sunny Central 800MV	Sunny Central 1000MV	Sunny Central 1250MV
<b>Input data</b>			
Nominal DC power	816 kW	1018 kW	1284 kW
Max. DC power	900 kW <sup>1)</sup>	1120 kW <sup>1)</sup>	1410 kW <sup>1)</sup>
MPP voltage range	450 V - 820 V <sup>5)</sup>	450 V - 820 V <sup>5)</sup>	500 V - 820 V <sup>5) 7)</sup>
Max. DC voltage	1000 V	1000 V	1000 V
Max. DC current	1986 A	2484 A	2844 A
Number of DC inputs	(16 + 16) + 4 DCHV	(16 + 16) + 4 DCHV	(16 + 16) + 4 DCHV
<b>Output data</b>			
Nominal AC power @ 45 °C	800 kVA	1000 kVA	1250 kVA
Continuous AC power @ 25 °C	880 kVA	1100 kVA	1400 kVA
Nominal AC voltage	20000 V	20000 V	20000 V
Nominal AC current	23.2 A	28.8 A	36.1 A
AC grid frequency 50 Hz	●	●	●
AC grid frequency 60 Hz	●	●	●
Power factor (cos φ)	0.9 leading ... 0.9 lagging		
Max. THD	< 3 %	< 3 %	< 3 %
<b>Power consumption</b>			
Internal consumption in operation	< 3000 W <sup>4)</sup>	< 3000 W <sup>4)</sup>	< 3000 W <sup>4)</sup>
Standby consumption	< 180 W + 1100 W	< 180 W + 1100 W	< 180 W + 1350 W
External auxiliary supply voltage	3 x 230 V, 50/60 Hz	3 x 230 V, 50/60 Hz	3 x 230 V, 50/60 Hz
External back-up fuse for auxiliary supply	B 20 A, 3-pole	B 20 A, 3-pole	B 20 A, 3-pole
<b>Dimensions and weight</b>			
Height	3620 mm	3620 mm	3620 mm
Width	5400 mm	5400 mm	5400 mm
Depth	3000 mm	3000 mm	3000 mm
Weight	35000 kg	35000 kg	35000 kg
<b>Efficiency<sup>2)</sup></b>			
Max. efficiency	97.7 %	97.9 %	97.8 %
Euro-eta	97.3 %	97.5 %	97.4 %
<b>Protection rating and ambient conditions</b>			
Protection rating (as per EN 60529)	IP54	IP54	IP54
Operating temperature range	-20 °C ... +45 °C	-20 °C ... +45 °C	-20 °C ... +45 °C
Rel. humidity	15 % ... 95 %	15 % ... 95 %	15 % ... 95 %
Fresh air consumption	12400 m <sup>3</sup> /h	12400 m <sup>3</sup> /h	12400 m <sup>3</sup> /h
Max. altitude (above sea level)	1000 m	1000 m	1000 m

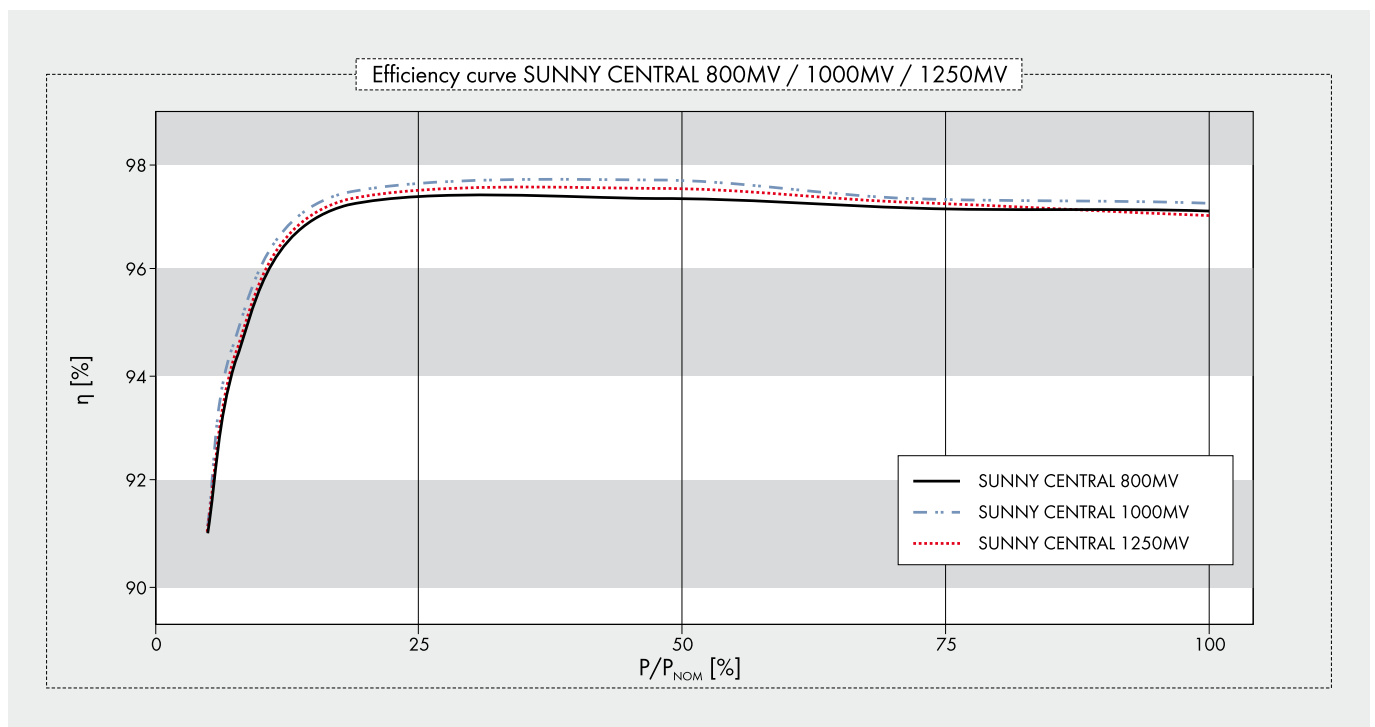

	Sunny Central 800MV	Sunny Central 1000MV	Sunny Central 1250MV
<b>Features</b>			
Display: text line / graphic	●/–	●/–	●/–
Ground fault monitoring	●	●	●
Heating	●	●	●
Emergency stop	●	●	●
Circuit breaker AC side	SI load disconnection switch	SI load disconnection switch	SI load disconnection switch
Circuit breaker DC side	Switch-disconnector with motor	Switch-disconnector with motor	Switch-disconnector with motor
Monitored overvoltage protectors AC / DC	●/●	●/●	●/●
Monitored overvoltage protectors for auxiliary supply	●	●	●
<b>SCC (Sunny Central Control) interfaces</b>			
Communication (NET Piggy-Back, optional)	analog, ISDN, Ethernet	analog, ISDN, Ethernet	analog, ISDN, Ethernet
Analog inputs	10 x A <sub>m</sub> <sup>3)</sup>	10 x A <sub>m</sub> <sup>3)</sup>	10 x A <sub>m</sub> <sup>3)</sup>
Overvoltage protection for analog inputs	○	○	○
Sunny String-Monitor connection (COM1)	RS485	RS485	RS485
PC connection (COM3)	RS232	RS232	RS232
Electrically separated relay (ext. alert signal)	2	2	2
<b>Certificates / listings</b>			
EMC	EN 61000-6-2 EN 61000-6-4		
CE conformity	●	●	●
BDEW-MSRL / FGW / TR8 <sup>6)</sup>	●	●	●
RD 1633 / 2000	●	●	●
Arrêté du 23/04/08	●	●	●
● standard features   ○ optional features   – not available			
Type designation	SC 800MV-11	SC 1000MV-11	SC 1250MV-11

HE: High Efficiency, inverter without galvanic isolation for connection to a medium-voltage transformer (taking into account the SMA specification for the transformer)

1) Specifications apply to irradiation values below STC

2) Efficiency measured without an internal power supply at  $U_{DC} = 500\text{ V}$

3) 2x inputs for the external nominal value specification for active power and reactive power, 1x external alarm input, 1x irradiation sensor, 1x pyranometer

4) Internal consumption at nominal power

5) At  $1.05 U_{AC, nom}$  and  $\cos \varphi = 1$

6) With limited dynamic grid support

7) At  $f_{grid} = 60\text{ Hz}$ : 510 V - 820 V

**Please note:** in certain countries the substations may differ from the substations shown in the images

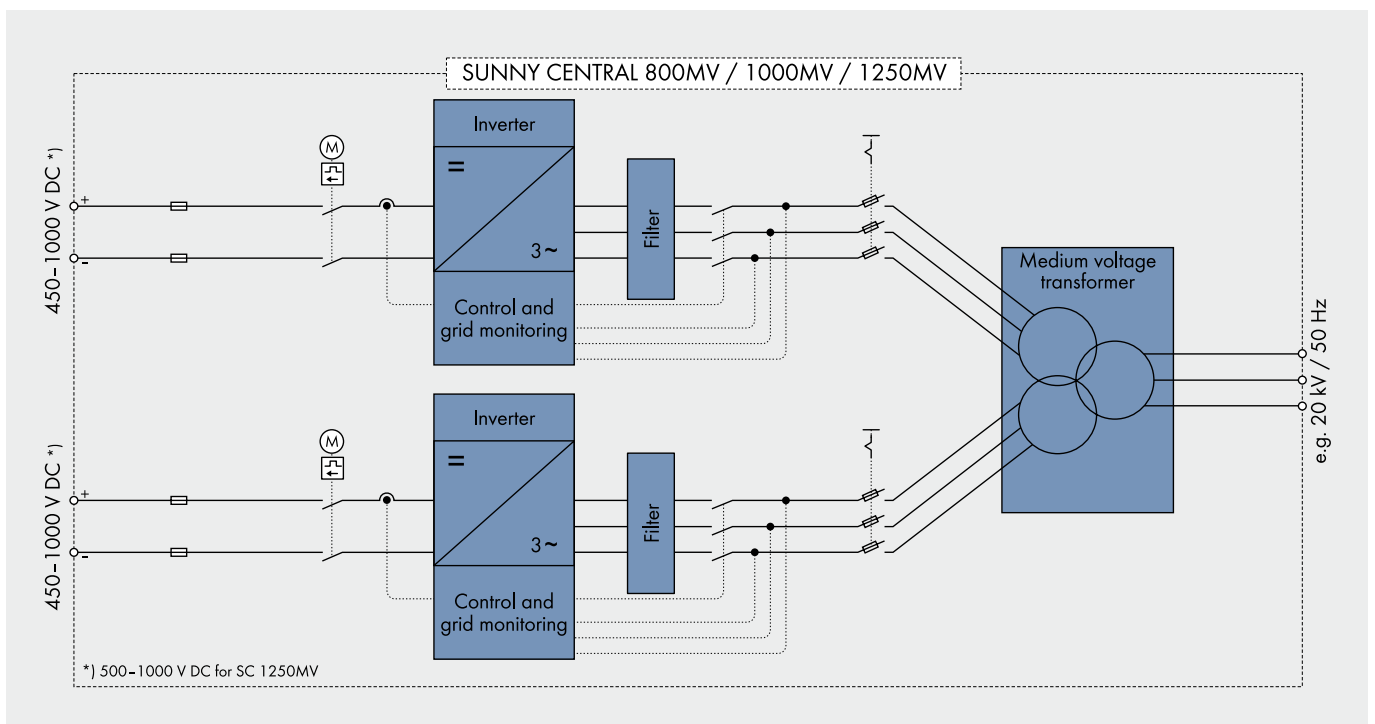

# POWERFUL GRID MANAGEMENT FUNCTIONS

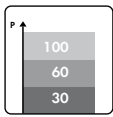

## Remote controlled power reduction in case of grid overload

In order to avoid short-term grid overload, the grid operator presets a nominal active power value which the inverter will implement within 60 seconds. The nominal value is transmitted to the inverters via a ripple control receiver in combination with the SMA Power Reducer Box. Typical limit values are 100, 60, 30 or 0 per cent of the nominal power.

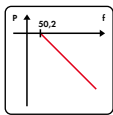

## Frequency-dependent control of active power

As of a grid frequency of 50.2 Hz, the inverter automatically reduces the fed-in of active power according to a definable characteristic curve which thereby contributes to the stabilization of the grid frequency.

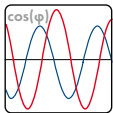

## Static voltage support based on reactive power

To stabilize the grid voltage, SMA inverters feed reactive power (leading or lagging) into the grid. Three different modes are available:

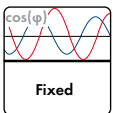

Fixed

### a) Fixed definition of the reactive power by the grid operator

The grid operator defines a fixed reactive power value or a fixed displacement factor between  $\cos(\varphi)_{\text{leading}} = 0.90$  and  $\cos(\varphi)_{\text{lagging}} = 0.90$ .

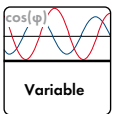

Variable

### b) Definition of a dynamic setpoint of the reactive power by the utility operator

The grid operator defines a dynamic displacement factor - any value between  $\cos(\varphi)_{\text{leading}} = 0.90$  und  $\cos(\varphi)_{\text{lagging}} = 0.90$ . It is transmitted either through a communication unit the evaluation can e.g. be evaluated and processed by the SMA Power Reducer Box.

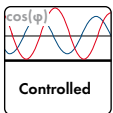

Controlled

### c) Control of the reactive power over a characteristic curve

The reactive power or the phase shift is controlled by a pre-defined characteristic curve - depending on the active power fed into the grid or the grid voltage.

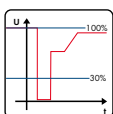

## Limited Dynamic Grid Support

The inverter continues to feed to the grid after short term voltage drops - as long as the grid voltage is within a defined voltage window.

SMA Solar Technologie Umrichteranlage Sunny Central SC 1000MV  
 Betrieb bei Nennleistung und 50 Hz; 1000 KW

A - bewerteter Schalleistungspegel LwA re 1 pW [dB(A)]

**IPK**

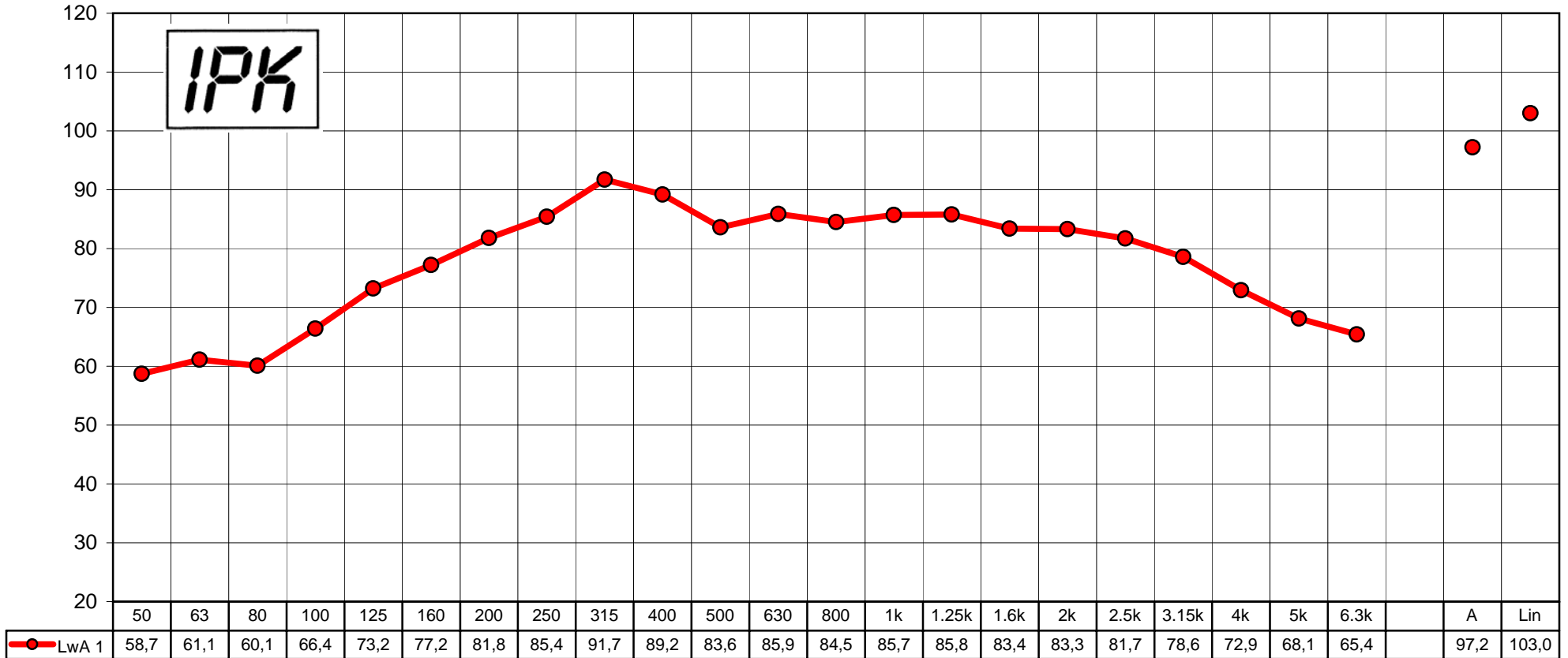

Terz - Mittenfrequenz [Hz]

**From:** Janos Rajda [mailto:Janos.Rajda@sma-america.com]  
**Sent:** Monday, October 18, 2010 9:38 AM  
**To:** Moran, Joaquin  
**Cc:** Mike Lord; Chris Rytel; Elie Nasr  
**Subject:** RE: Noise Levels - U R G E N T

Hi Joaquin,

Yes it will apply as two (2) 625kW, 60Hz are complete mechanical equivalents to two (2) 500kW, 50Hz or to a 1000kW 2-units system. The slight electrical difference between the two units relate to minimum DC voltage rating and grid frequency the units are connected to with no significant impact on levels of unit parts audio noise generation.

Regards,

Janos

---

**From:** Moran, Joaquin [mailto:JMoran@Hatch.ca]  
**Sent:** October-18-10 9:13 AM  
**To:** Janos Rajda  
**Cc:** Mike Lord; Chris Rytel; Elie Nasr  
**Subject:** RE: Noise Levels - U R G E N T

Hi Janos,

Thanks for the information. Just to clarify, the sound power levels provided seem to be for a 1000 kW unit, 50 Hz. Will these apply to the units to be deployed in this case (625 kW, 60 Hz)?

Cheers,

Joaquin

---

**Joaquin E. Moran**  
Tel. +1 905 374-0701 x 5236

---

**From:** Janos Rajda [mailto:Janos.Rajda@sma-america.com]  
**Sent:** Sunday, October 17, 2010 11:22 PM  
**To:** Moran, Joaquin  
**Cc:** Mike Lord; Chris Rytel; Elie Nasr  
**Subject:** RE: Noise Levels - U R G E N T

Hi Joaquin,

Over the weekend we obtained third octave sound power levels for 100% or rated loading case for two SC units as supplied at the time for FirstSolar project in Sarnia.

Thanks again for providing as with sample data, which proved to be helpful in communicating the sound power level format requirement.

Best regards,

Janos

## Acoustical Louver J Blade

### Application and Design

AFJ-601 is an acoustical weather louver designed to protect air intake and exhaust openings in building exterior walls. Design incorporates J style insulated acoustical blades and high free area to provide maximum resistance to sound transmission, rain and weather while providing minimum resistance to airflow. The AFJ-601 is an extremely efficient louver with **AMCA LICENSED PERFORMANCE DATA** enabling designers to select and apply with confidence.

### Standard Construction

- Frame** . . . . . Heavy gauge formed aluminum,  
6 in. x 0.080 in. nominal wall thickness
- Blades** . . . . . J style, heavy gauge formed aluminum,  
0.080 in. nominal wall thickness, positioned  
at 45° on approximately 5 in. centers
- Construction** . . . Mechanically fastened
- Acoustical  
Insulation** . . . . . Fiberglass Insulation
- Birdscreen** . . . . . 3/4 in. x 0.051 flattened expanded aluminum in  
removable frame, inside mount (rear)
- Finish** . . . . . Mill
- Minimum Size** . . 12 in. W x 15 in. H
- Maximum Single  
Section Size** . . . 60 in. W x 120 in. H

### Options (at additional cost)

- A variety of bird and insect screens
- Blank off panels
- Clip angles
- Extended sill
- Filter racks
- Flanged frame
- Galvanized steel frame and blade
- Security bars
- A variety of architectural finishes including:
  - Clear anodize
  - Integral color anodize
  - Baked enamel paint
  - Kynar paint

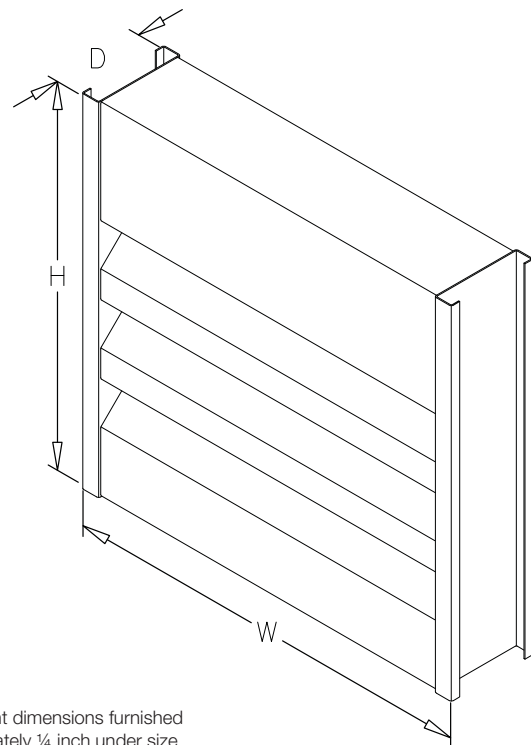
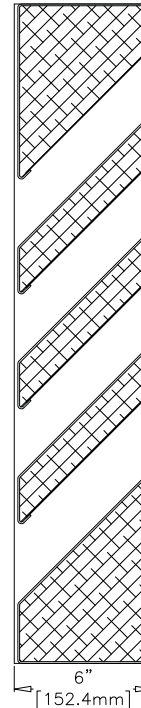

\*Width and height dimensions furnished approximately 1/4 inch under size.

# PERFORMANCE DATA

# AFJ-601

## Free Area Chart (Sq. ft.)

## J Blade Acoustical Louver Formed Aluminum

Louver Height Inches	Louver Width Inches								
	12	18	24	30	36	42	48	54	60
15	0.12	0.21	0.29	0.37	0.45	0.53	0.61	0.69	0.77
18	0.25	0.41	0.57	0.74	0.90	1.06	1.22	1.38	1.55
24	0.37	0.62	0.86	1.10	1.35	1.59	1.83	2.08	2.32
30	0.50	0.82	1.15	1.47	1.80	2.12	2.44	2.77	3.09
36	0.62	1.03	1.43	1.84	2.24	2.65	3.05	3.46	3.86
42	0.75	1.24	1.72	2.21	2.69	3.18	3.67	4.15	4.64
<b>48</b>	<b>1.00</b>	<b>1.65</b>	<b>2.30</b>	<b>2.94</b>	<b>3.59</b>	<b>4.24</b>	<b>4.89</b>	<b>5.54</b>	<b>6.18</b>
54	1.12	1.85	2.58	3.31	4.04	4.77	5.50	6.23	6.96
60	1.25	2.06	2.87	3.68	4.49	5.30	6.11	6.92	7.73
66	1.37	2.26	3.16	4.05	4.94	5.83	6.72	7.61	8.50
72	1.50	2.47	3.44	4.41	5.39	6.36	7.33	8.30	9.27
78	1.75	2.88	4.02	5.15	6.28	7.42	8.55	9.69	10.82
84	1.87	3.09	4.30	5.52	6.73	7.95	9.16	10.38	11.59
90	2.00	3.29	4.59	5.89	7.18	8.48	9.77	11.07	12.37
96	2.12	3.50	4.88	6.25	7.63	9.01	10.38	11.76	13.14
102	2.25	3.71	5.16	6.62	8.08	9.54	11.00	12.45	13.91
108	2.50	4.12	5.74	7.36	8.98	10.60	12.22	13.84	15.46
114	2.62	4.32	6.02	7.73	9.43	11.13	12.83	14.53	16.23
120	2.75	4.53	6.31	8.09	9.88	11.66	13.44	15.22	17.00



Greenheck Fan Corporation certifies that the AFJ-601 louvers shown herein are licensed to bear the AMCA Seal. The ratings shown are based on tests and procedures performed in accordance with AMCA Publication 511 and comply with the requirements of the AMCA Certified Ratings Program. The AMCA Certified Ratings Seal applies to water penetration, air performance and sound ratings.

## Sound Transmission Class

The Sound Transmission Class (STC) is a rating of the effectiveness of an assembly in isolating or reducing airborne sound transmission. STC is a single number that summarizes airborne sound transmission loss data. Assemblies with higher STC ratings are more efficient at reducing sound transmission. STC is determined in accordance with ASTM E413-04.

## Transmission Loss

Transmission loss (TL) is a measurement of the reduction of sound power transmission (dB) through an assembly at a given frequency. The more sound power that is reduced, the greater the TL. TL is tested in accordance with ASTM E90-04.

## Free Field Noise Reduction in Decibels

Free Field Noise Reduction is determined by adding 6 dB to the Transmission Loss.

Octave Band	2	3	4	5	6	7	STC
Frequency (Hz)	63	125	250	500	1000	2000	10
Transmission Loss (dB)	4	4	6	10	17	12	
Free Field Noise Reduction (dB)	10	10	12	16	23	18	

## Airflow Resistance (Standard Air - .075 lb/ft<sup>3</sup>)

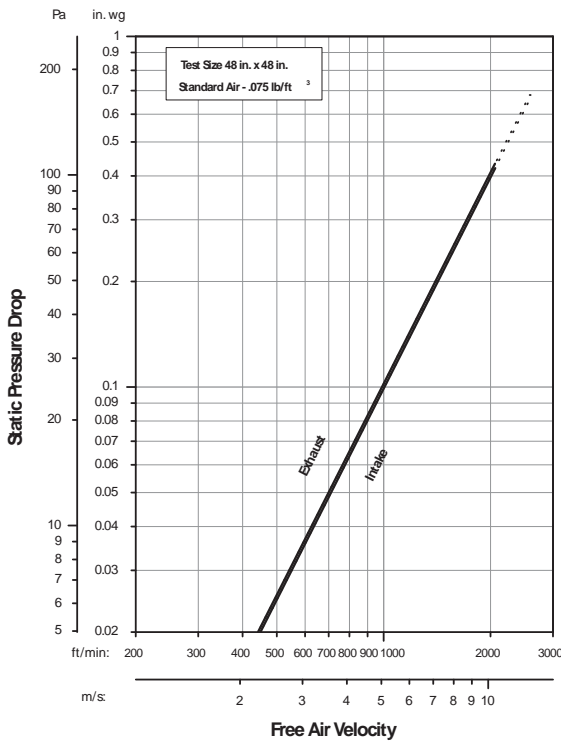

Model AFJ-601 resistance to airflow (pressure drop) varies depending on louver application (air intake or air exhaust). Free area velocities (shown) are higher than average velocity through the overall louver size. See louver selection information.

## Water Penetration (Standard Air - .075 lb/ft<sup>3</sup>)

Test size 48 in. x 48 in. Test duration of 15 min.

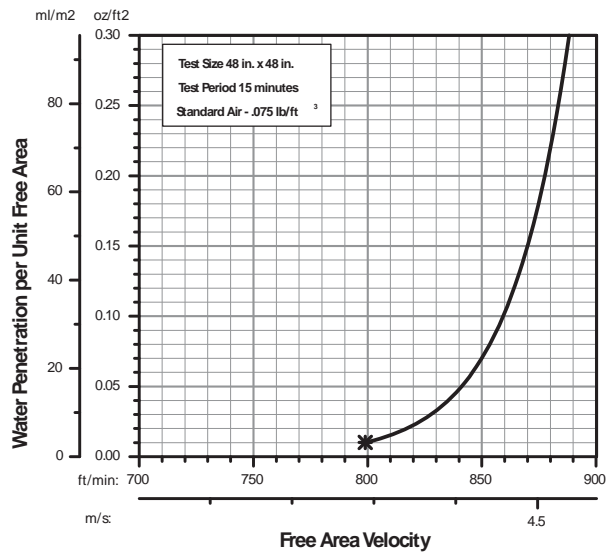

The AMCA Water Penetration Test provides a method for comparing various louver models and designs as to their efficiency in resisting the penetration of rainfall under specific laboratory test conditions. The beginning point of water penetration is defined as that velocity where the water penetration curve projects through .01 oz. of water (penetration) per sq. ft. of louver free area.

**\*The beginning point of water penetration for Model AFJ-601 is 799 fpm free area velocity.** These performance ratings do not guarantee a louver to be weatherproof or stormproof and should be used in combination with other factors including good engineering judgement in selecting louvers.



# INSTALLATION DETAILS

# AFJ-601

## Maximum Size and Installation Information

J Blade Acoustical Louver  
Formed Aluminum

Maximum single section size for model AFJ-601 is 60 in. W x 120 in. H. Larger openings require field assembly of multiple louver panels to make up the overall opening size. Individual louver panels are designed to withstand a 25 PSF wind-load (please consult Greenheck if the louvers must withstand higher wind-loads). Structural reinforcing members may be required to adequately support and install multiple louver panels within a large opening. Structural reinforcing members along with any associated installation hardware is not provided by Greenheck unless indicated otherwise by Greenheck. Additional information on louver installation may be found in AMCA Publication #501, Louver Application Manual.

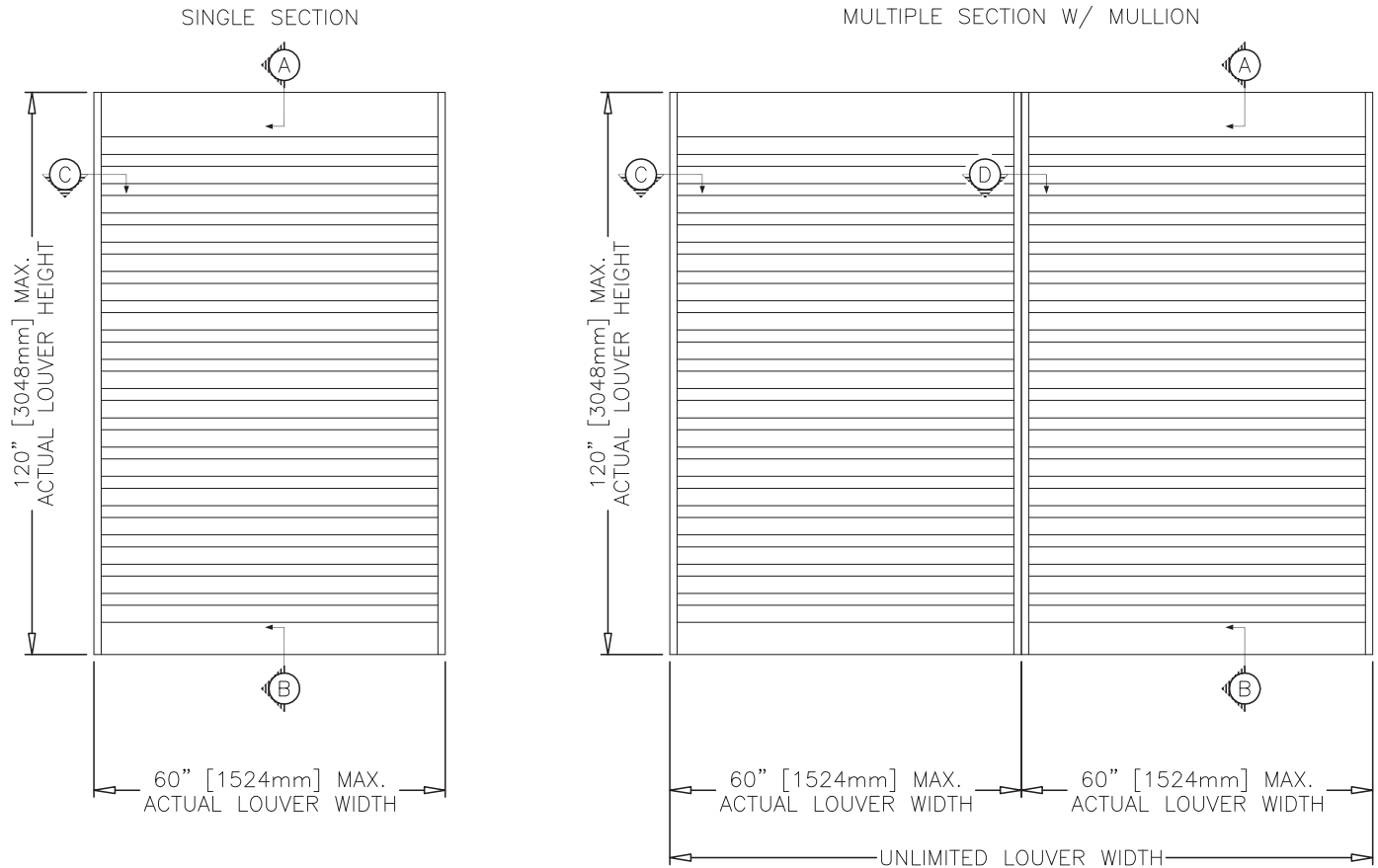

**Minimum Single Section Size**  
12 in. W x 15 in. H

**Maximum Single Section Size**  
60 in. W x 120 in. H



# PRODUCT DETAILS

# AFJ-601

J Blade Acoustical Louver  
Formed Aluminum

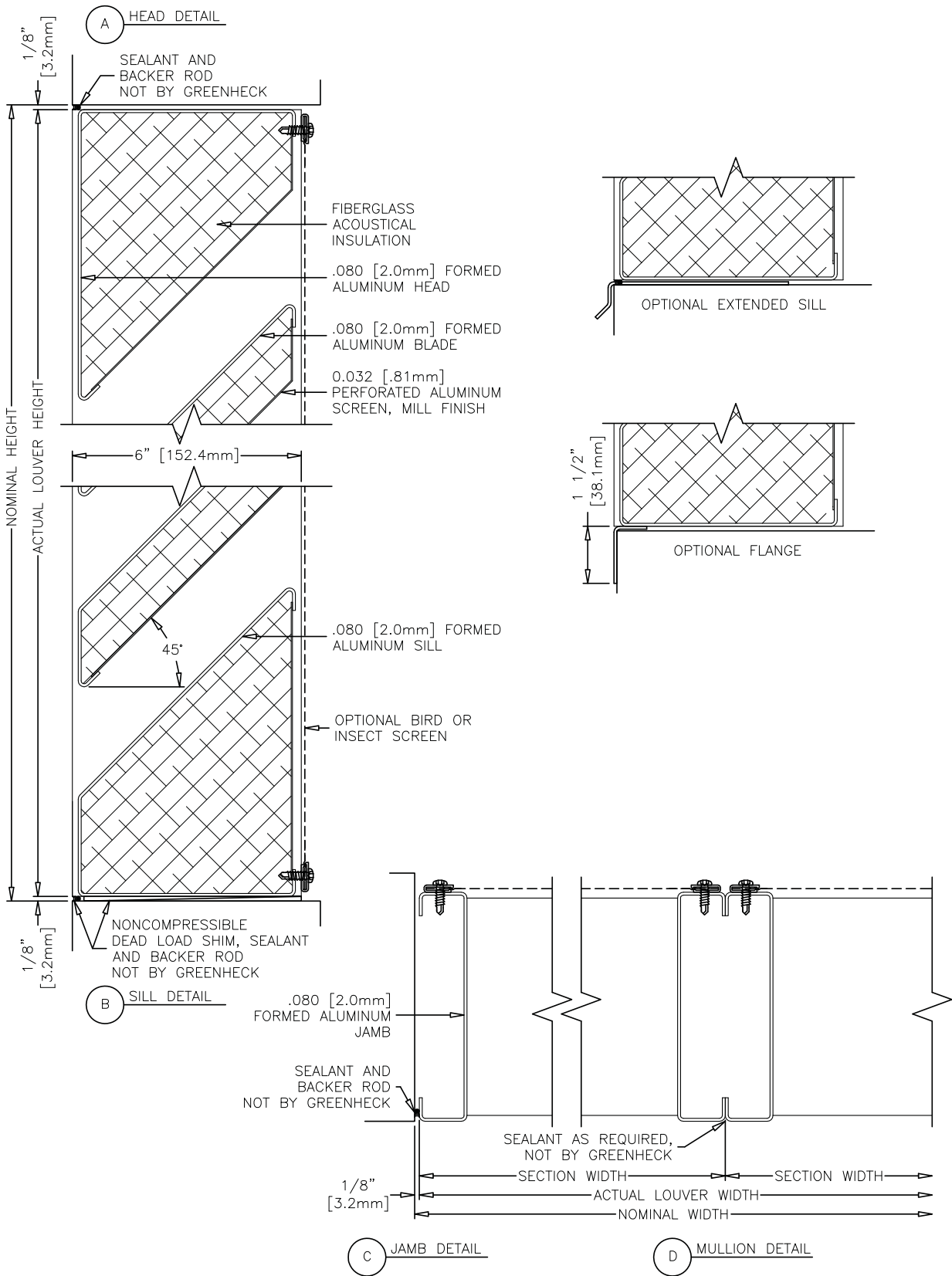

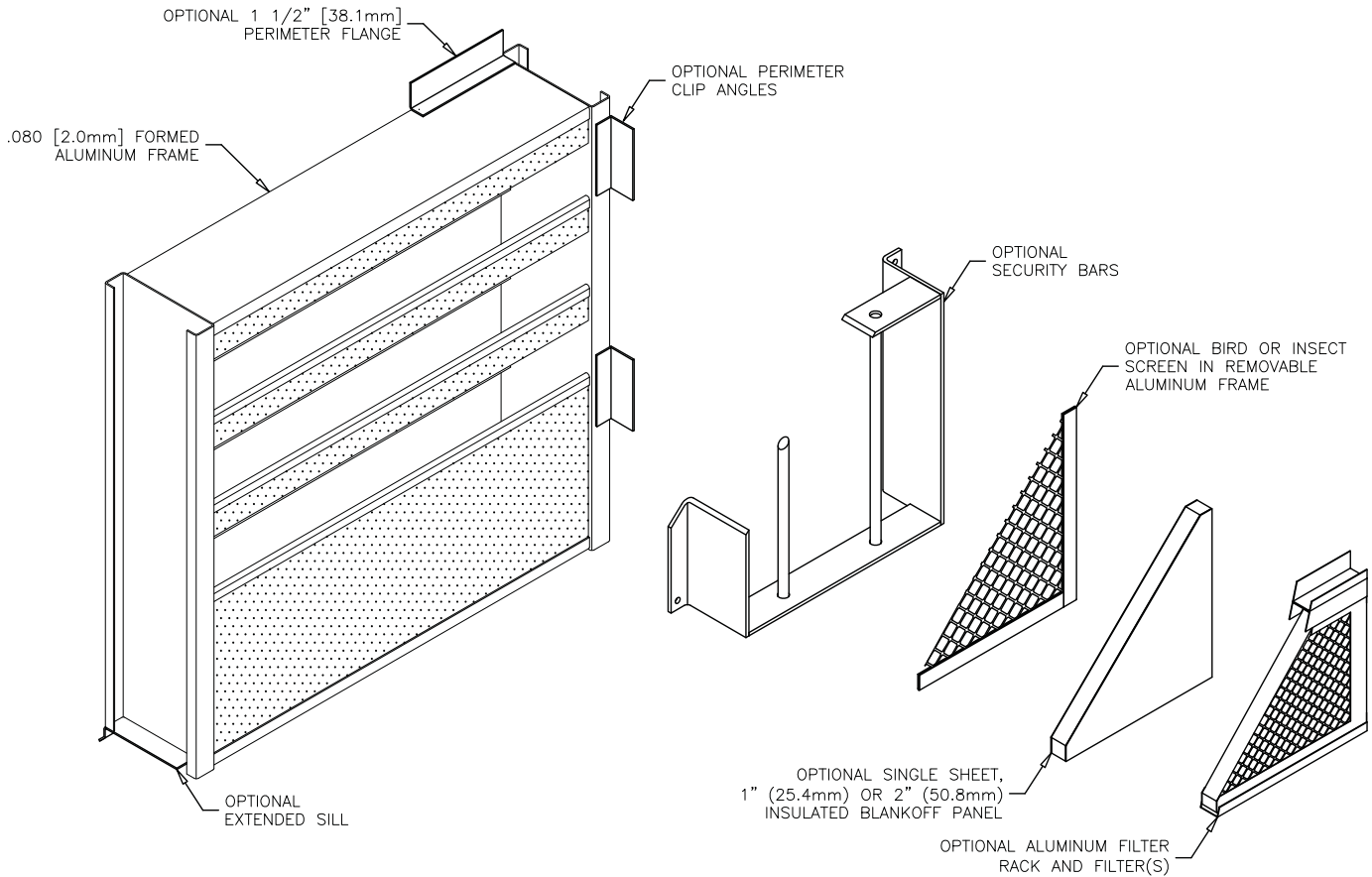

## FINISHES

Finish Type	Description/Application	Color Selection	Standard Warranty (Aluminum)
2-coat 70% KYNAR 500®/HYLAR 5000® AAMA 2605 – Dry film thickness 1.2 mil. (AKA: Duranar®, Fluoropon®, Trinar®, Flouropolymer, Polyvinylidene Fluoride, PVDF2)	<b>“Best.”</b> The premier finish for extruded aluminum. Tough, long-lasting coating has superior color retention and abrasive properties. Resists chalking, fading, chemical abrasion and weathering.	<b>Standard Colors:</b> Any of the 24 standard colors shown can be furnished in 70% or 50% KYNAR 500®/HYLAR 5000® or Baked Enamel.  <b>2-Coat Mica:</b> Greenheck offers 9 standard 2-coat Mica colors. Other colors are available. Consult Greenheck for possible extra cost when selecting non-standard colors or special finishes.	10 Years (Consult Greenheck for availability of extended warranty)
2-coat 50% KYNAR 500®/HYLAR 5000® AAMA 2604 – Dry film thickness 1.2 mil. (AKA: Acroflur®, Acrynar®)	<b>“Better.”</b> Tough, long-lasting coating has excellent color retention and abrasive properties. Resists chalking, fading, chemical abrasion and weathering.		5 Years
Baked Enamel AAMA 2603 – Dry film thickness 0.8 mil. (AKA: Acrabond Plus®, Duracron®)	<b>“Good.”</b> Provides good adhesion and resistance to weathering, corrosion and chemical stain.		1 Year
Integral Color Anodize AA-M10C22A42 (>0.7 mil)	“Two-step” anodizing is produced by following the normal anodizing step with a second, colorfast process.	Light, Medium or Dark Bronze; Champagne; Black	5 years
Clear Anodize 215 R-1 AA-M10C22A41 (>0.7 mil)	Clear, colorless and hard oxide aluminum coating that resists weathering and chemical attack.	Clear	5 years
Clear Anodize 204 R-1 AA-M10C22A31 (0.4-0.7 mil)	Clear, colorless and hard oxide aluminum coating that resists weathering and chemical attack.	Clear	1 Year
Industrial coatings	Greenheck offers a number of industrial coatings such as Hi-Pro Polyester, Epoxy, and Permatector®. Consult a Greenheck Product Specialist for complete color and application information.		Consult Greenheck
Mill	Materials may be supplied in natural aluminum or galvanized steel finish when normal weathering is acceptable and there is no concern for color or color change.		n/a

Finishes meet or exceed AAMA 2605, AAMA 2604, and AAMA 2603 requirements. Please consult [www.greenheck.com](http://www.greenheck.com) for complete information on standard and extended paint warranties. Paint finish warranties are not applicable to steel products.



Blank back



**Figure B1** Location and ID of Proposed Sound Barriers

# Appendix C

## Sound Pressure Levels for Points of Reception, Noise Maps from CADNA-A

**Table C1 Sound Pressure Levels for POR (shaded rows correspond to representative POR)**

ID	Level Lp		Limit. Value		Noise Type	Height (m)	Coordinates		
	Day (dBA)	Night (dBA)	Day (dBA)	Night (dBA)			X (m)	Y (m)	Z (m)
1	37.8	37.8	45.0	40.0	Total	4.5	314528	4881967	106.7
2	39.1	39.1	45.0	40.0	Total	4.5	314446	4881905	109.1
3	38.6	38.6	45.0	40.0	Total	4.5	314449	4881924	108.6
4	36.8	36.8	45.0	40.0	Total	4.5	314517	4881986	106.9
5	38.0	38.0	45.0	40.0	Total	4.5	314407	4881894	109.5
6	37.4	37.4	45.0	40.0	Total	4.5	314418	4881934	108.8
7	35.2	35.2	45.0	40.0	Total	4.5	314573	4882033	105.6
8	37.3	37.3	45.0	40.0	Total	4.5	314386	4881899	109.5
9	37.4	37.4	45.0	40.0	Total	4.5	314375	4881870	109.5
10	36.8	36.8	45.0	40.0	Total	4.5	314364	4881891	109.5
11	33.9	33.9	45.0	40.0	Total	4.5	314646	4882059	104.5
12	33.8	33.8	45.0	40.0	Total	4.5	314633	4882067	104.5
13	37.4	37.4	45.0	40.0	Total	4.5	314830	4881714	109.5
14	37.3	37.3	45.0	40.0	Total	4.5	314838	4881704	109.5
15	36.0	36.0	45.0	40.0	Total	4.5	314303	4881859	109.5
16	35.6	35.6	45.0	40.0	Total	4.5	314304	4881888	109.5
17	30.5	30.5	45.0	40.0	Total	4.5	314812	4882122	104.5
18	30.1	30.1	45.0	40.0	Total	4.5	314836	4882129	104.5
19	29.6	29.6	45.0	40.0	Total	4.5	314882	4882126	105.1
20	29.0	29.0	45.0	40.0	Total	4.5	314897	4882154	105.0
21	26.8	26.8	45.0	40.0	Total	4.5	314847	4882209	100.5
22	26.3	26.3	45.0	40.0	Total	4.5	314842	4882221	100.2
23	28.7	28.7	45.0	40.0	Total	4.5	314923	4882158	105.2
24	28.4	28.4	45.0	40.0	Total	4.5	314939	4882166	105.6
25	28.2	28.2	45.0	40.0	Total	4.5	314798	4882267	104.1
26	28.1	28.1	45.0	40.0	Total	4.5	314943	4882183	105.7
27	27.5	27.5	45.0	40.0	Total	4.5	314835	4882298	104.1
28	27.7	27.7	45.0	40.0	Total	4.5	315014	4882180	108.2
29	27.4	27.4	45.0	40.0	Total	4.5	315002	4882210	107.8
30	33.3	33.3	45.0	40.0	Total	4.5	314044	4881631	109.5
31	33.0	33.0	45.0	40.0	Total	4.5	314033	4881665	109.5
32	32.5	32.5	45.0	40.0	Total	4.5	313996	4881652	109.5
33	26.5	26.5	45.0	40.0	Total	4.5	315053	4882253	108.1
34	28.5	28.5	45.0	40.0	Total	4.5	314336	4882430	111.8
35	24.7	24.7	45.0	40.0	Total	4.5	315080	4882285	107.0
36	28.3	28.3	45.0	40.0	Total	4.5	314326	4882446	112.0
37	31.4	31.4	45.0	40.0	Total	4.5	313909	4881549	109.5
38	32.0	32.0	45.0	40.0	Total	4.5	313945	4881437	109.5
39	23.9	23.9	45.0	40.0	Total	4.5	315149	4882354	108.2
40	30.9	30.9	45.0	40.0	Total	4.5	313873	4881540	109.5
41	26.6	26.6	45.0	40.0	Total	4.5	314410	4882618	114.5
42	26.9	26.9	45.0	40.0	Total	4.5	315181	4882392	109.1
43	26.6	26.6	45.0	40.0	Total	4.5	314324	4882608	114.5
44	30.4	30.4	45.0	40.0	Total	4.5	313830	4881476	109.5
45	23.5	23.5	45.0	40.0	Total	4.5	315170	4882450	106.1
46	26.5	26.5	45.0	40.0	Total	4.5	315236	4882400	109.5

ID	Level Lp		Limit. Value		Noise Type	Height (m)	Coordinates		
	Day (dBA)	Night (dBA)	Day (dBA)	Night (dBA)			X (m)	Y (m)	Z (m)
47	26.1	26.1	45.0	40.0	Total	4.5	314231	4882630	114.5
48	26.2	26.2	45.0	40.0	Total	4.5	315253	4882429	109.5
49	26.2	26.2	45.0	40.0	Total	4.5	315242	4882444	109.5
50	29.3	29.3	45.0	40.0	Total	4.5	313752	4881330	109.5
51	28.9	28.9	45.0	40.0	Total	4.5	313725	4881319	109.5
52	28.7	28.7	45.0	40.0	Total	4.5	313698	4881344	109.5
53	24.4	24.4	45.0	40.0	Total	4.5	314035	4882750	114.5
54	30.4	30.4	45.0	40.0	Total	4.5	315167	4880909	109.5
55	27.7	27.7	45.0	40.0	Total	4.5	313608	4881314	109.5
56	29.9	29.9	45.0	40.0	Total	4.5	315185	4880875	109.5
57	29.3	29.3	45.0	40.0	Total	4.5	315299	4880947	109.9
58	28.0	28.0	45.0	40.0	Total	4.5	313683	4881143	109.5
59	27.6	27.6	45.0	40.0	Total	4.5	313618	4881215	109.5
60	24.5	24.5	45.0	40.0	Total	4.5	313599	4882409	111.2
61	29.5	29.5	45.0	40.0	Total	4.5	315203	4880843	110.2
62	27.8	27.8	45.0	40.0	Total	4.5	313662	4881130	109.5
63	29.3	29.3	45.0	40.0	Total	4.5	315216	4880831	110.8
64	24.1	24.1	45.0	40.0	Total	4.5	313652	4882538	112.3
65	28.6	28.6	45.0	40.0	Total	4.5	315335	4880906	111.1
66	24.2	24.2	45.0	40.0	Total	4.5	313574	4882438	111.4
67	26.9	26.9	45.0	40.0	Total	4.5	313544	4881246	109.5
68	24.3	24.3	45.0	40.0	Total	4.5	313516	4882351	110.8
69	27.2	27.2	45.0	40.0	Total	4.5	313590	4881166	109.5
70	26.7	26.7	45.0	40.0	Total	4.5	313528	4881224	109.5
71	28.1	28.1	45.0	40.0	Total	4.5	315357	4880853	112.2
72	26.8	26.8	45.0	40.0	Total	4.5	313551	4881144	109.5
73	28.3	28.3	45.0	40.0	Total	4.5	315261	4880765	113.6
74	23.7	23.7	45.0	40.0	Total	4.5	313551	4882523	112.1
75	23.6	23.6	45.0	40.0	Total	4.5	313539	4882514	112.0
76	26.3	26.3	45.0	40.0	Total	4.5	313487	4881209	109.5
77	23.5	23.5	45.0	40.0	Total	4.5	313535	4882529	112.2
78	23.2	23.2	45.0	40.0	Total	4.5	313692	4882727	113.8
79	23.2	23.2	45.0	40.0	Total	4.5	313696	4882738	113.9
80	27.6	27.6	45.0	40.0	Total	4.5	315383	4880816	113.1
81	27.9	27.9	45.0	40.0	Total	4.5	315253	4880707	114.5
82	27.8	27.8	45.0	40.0	Total	4.5	315280	4880715	114.5
83	25.9	25.9	45.0	40.0	Total	4.5	313445	4881196	109.5
84	26.0	26.0	45.0	40.0	Total	4.5	313452	4881183	109.5
85	25.7	25.7	45.0	40.0	Total	4.5	313472	4881127	109.5
86	19.3	19.3	45.0	40.0	Total	4.5	315413	4882863	105.8
87	22.5	22.5	45.0	40.0	Total	4.5	315448	4882850	108.5
88	23.0	23.0	45.0	40.0	Total	4.5	313456	4882543	112.4
89	19.0	19.0	45.0	40.0	Total	4.5	315411	4882903	103.3
90	22.3	22.3	45.0	40.0	Total	4.5	315477	4882878	109.1
91	18.8	18.8	45.0	40.0	Total	4.5	315444	4882923	105.6
92	26.9	26.9	45.0	40.0	Total	4.5	315346	4880651	114.5
93	18.7	18.7	45.0	40.0	Total	4.5	315467	4882936	106.1

ID	Level Lp		Limit. Value		Noise Type	Height (m)	Coordinates		
	Day (dBA)	Night (dBA)	Day (dBA)	Night (dBA)			X (m)	Y (m)	Z (m)
94	22.0	22.0	45.0	40.0	Total	4.5	315539	4882876	109.5
95	25.3	25.3	45.0	40.0	Total	4.5	315369	4880617	114.5
96	16.5	16.5	45.0	40.0	Total	4.5	315345	4883062	83.5
97	18.1	18.1	45.0	40.0	Total	4.5	315489	4882976	105.8
98	25.7	25.7	45.0	40.0	Total	4.5	315480	4880665	114.5
99	16.4	16.4	45.0	40.0	Total	4.5	315383	4883066	86.6
100	18.1	18.1	45.0	40.0	Total	4.5	315504	4882981	105.9



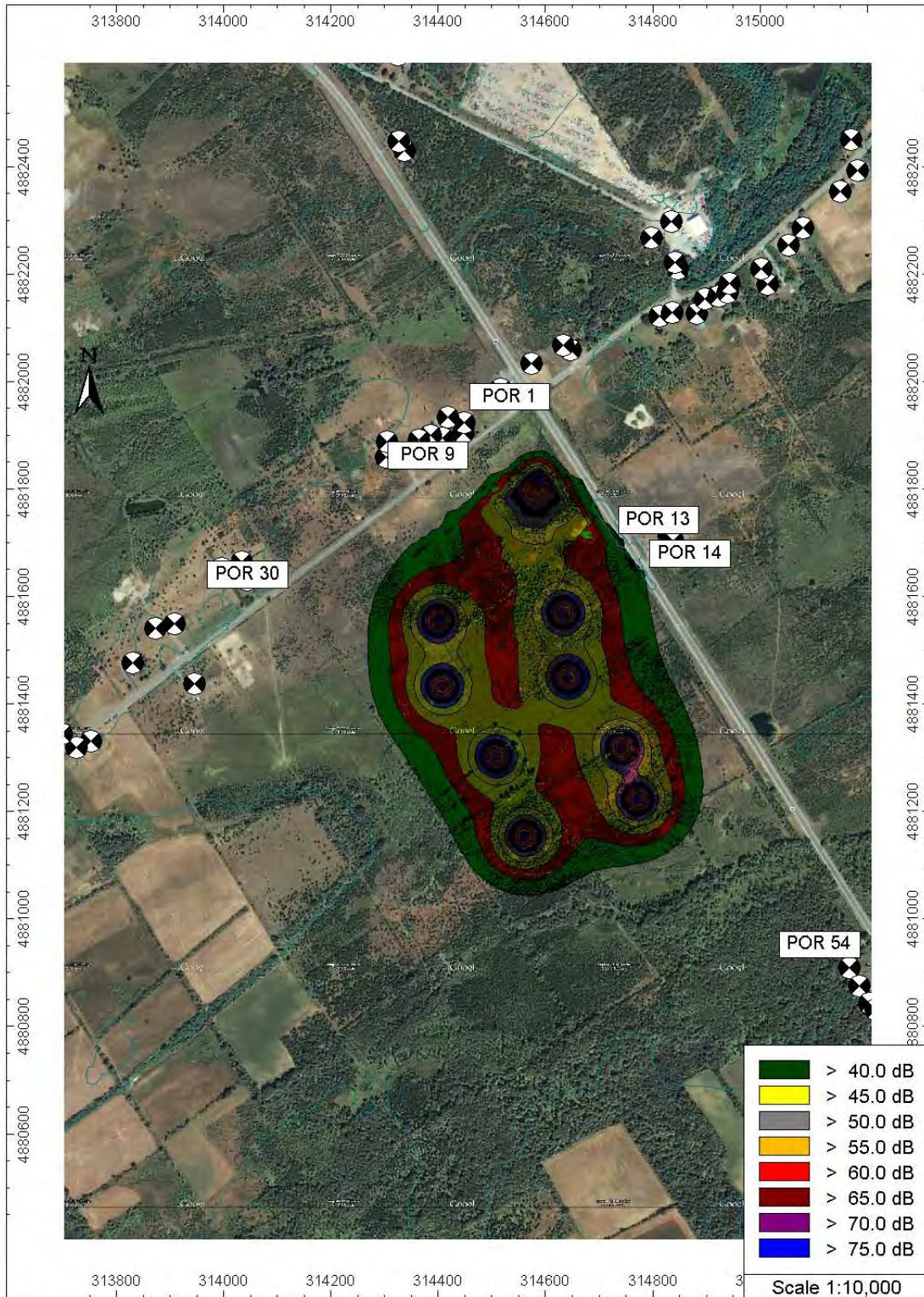

Figure C1 Noise Map

